



OWNER'S MANUAL

AXOPAR 37 XC CROSS CABIN

MODEL YEAR 2025

AXOPAR 

Table of Contents

1 Introduction.....	5
1.1 Purpose of this manual.....	5
1.2 Safety symbols.....	5
1.3 Document conventions.....	6
1.4 Copyright.....	6
1.5 Disclaimer	6
1.6 Warranty.....	7
2 Safety.....	8
2.1 Safe and responsible boat operation.....	8
2.2 Safety diagram.....	10
2.3 Fire protection and control.....	10
2.3.1 Fire control equipment.....	11
2.3.2 Boat owners' and users' responsibilities.....	11
2.3.3 Checklist: Fire in the engine.....	12
2.3.4 Checklist: After fire.....	12
2.4 Carbon monoxide.....	12
2.5 Carbon monoxide monitor.....	14
2.6 Smoke alarm.....	14
2.7 Life raft.....	15
2.8 Safety labels on board.....	15
3 Product overview.....	24
3.1 Purpose of use.....	24
3.2 Identification.....	24
3.3 Builder's plate.....	25
3.4 CE certification.....	25
3.5 Dimensions and weight.....	25
3.6 Boat layout.....	27
4 Product description.....	30
4.1 Stability and buoyancy.....	30
4.1.1 Self-draining systems.....	30
4.1.2 Openings in the hull and deck.....	31
4.1.3 Bilge system.....	33
4.1.3.1 Bilge pumps and outlets.....	34
4.2 Technical systems.....	36
4.2.1 Electrical system.....	36
4.2.2 12V system.....	37

4.2.3 Main switches.....	38
4.2.4 Direct supply fuses.....	39
4.2.5 Fuses.....	39
4.2.6 Heavy duty fuses.....	40
4.2.7 Batteries.....	40
4.2.7.1 Charging the batteries.....	41
4.2.7.2 Winter storage	41
4.2.7.3 Cleaning the batteries	41
4.2.8 110/230V system.....	41
4.2.9 Fuel system.....	43
4.2.9.1 Refueling the boat.....	44
4.2.9.2 Maintaining the fuel system.....	45
4.3 Optional equipment.....	45
4.3.1 Freshwater system.....	45
4.3.2 Warmwater system.....	47
4.3.3 Wet bar in port fender box.....	47
4.3.4 Septic system.....	49
4.3.4.1 Toilet seat.....	49
4.3.4.2 Septic tank.....	50
4.3.4.3 Shower sump pump.....	50
4.3.5 Heating system.....	51
4.3.6 Air conditioning.....	51
4.3.7 Navigation system.....	52
4.3.7.1 VHF equipment.....	52
4.3.8 Bow thruster.....	52
4.3.9 Anchor windlass.....	53
4.3.10 LPG system.....	54
4.3.10.1 Lighting the LPG cooker.....	56
4.3.10.2 Using the LPG cooker.....	56
4.3.11 Solar panel trickle charger.....	57
4.3.12 Lithium power bank.....	57
4.3.13 Inverter and battery monitor.....	58
4.3.14 Fender box baitwell.....	58
4.3.15 Roof racks.....	59
4.3.16 Searchlight.....	59
4.3.17 Gas grill.....	59
4.3.18 Sunshades.....	60
5 Transportation.....	62
5.1 Lifting the boat.....	62
5.2 Transporting and storing the boat.....	63

6 Operation.....	65
6.1 Handling devices.....	65
6.1.1 Steering console.....	65
6.1.2 Windscreen wipers	66
6.1.3 Steering system.....	67
6.1.3.1 Checking and topping up oil	67
6.1.3.2 Steering maintenance	67
6.1.3.3 Steering console switch panel.....	68
6.1.4 Starting the engine.....	68
6.1.5 Throttle lever.....	69
6.1.5.1 Trim and tilt.....	69
6.2 Swivel seat - Driver and passenger seats.....	69
6.3 Inspecting the boat.....	70
6.3.1 Checklist: Regular inspection before leaving harbor.....	70
6.3.2 Checklist: After using the boat.....	71
6.4 Handling the boat.....	71
6.4.1 Checklist: Boat handling before leaving harbor	71
6.4.2 Leaving the jetty	72
6.4.3 Driving the boat.....	72
6.4.3.1 Dead man's switch	73
6.4.3.2 Driving at high speed.....	73
6.4.3.3 Driving in rough seas.....	74
6.4.3.4 Maneuvering in narrow channels.....	74
6.4.4 Visibility from steering position.....	75
6.4.5 Using the trim tabs.....	75
6.5 Preventing falling overboard.....	76
6.6 Anchoring, docking and mooring.....	77
6.6.1 Fastening points.....	77
6.6.2 Docking.....	77
6.6.3 Checklist: Before anchoring	78
6.6.4 Towing and mooring.....	78
7 Maintenance.....	79
7.1 Cleaning and maintaining the gelcoat surface.....	79
7.2 Antifouling.....	81
7.3 Maintaining the interiors.....	82
7.3.1 Wooden interiors.....	82
7.3.2 Plastic and painted surfaces.....	82
7.3.3 Fabrics.....	82
7.3.4 Doors and hatches.....	82
7.4 Maintaining the cover.....	82
7.4.1 Cleaning the cover.....	83
7.5 Protecting underwater metal parts.....	83

7.6 Preventing corrosion.....	84
7.7 Preventing frost damage.....	84
7.8 Checklist: Before winter lay-up.....	84
7.9 Checklist: Before launching.....	85
7.10 Corrective maintenance.....	85
7.10.1 Deposits.....	85
7.10.2 Scratches and nicks.....	86
7.10.3 Stains.....	86
7.10.4 Deep marks, gouges and holes.....	86
8 Environment.....	87
8.1 Requirements for North America.....	87
9 Appendix I: Checklists.....	89
9.1 Checklist: Fire in the engine.....	89
9.2 Checklist: After fire.....	89
9.3 Checklist: After grounding.....	89
9.4 Checklist: Regular inspection before leaving harbor.....	90
9.5 Checklist: After using the boat.....	91
9.6 Checklist: Boat handling before leaving harbor	91
9.7 Checklist: Before anchoring	91
9.8 Checklist: Before winter lay-up.....	92
9.9 Checklist: Before launching.....	92
10 Appendix II: Fuel system.....	94
11 Appendix III: Electrical diagrams.....	95
12 Appendix IV: AIS Decontamination – North America.....	96
13 Appendix V: Strapping and transport.....	97

1 Introduction

1.1 Purpose of this manual

This owner's manual contains important information and instructions for using your boat.

In this owner's manual you can find important information that help you handle and maintain your boat. The manual contains detailed information about the boat and the systems installed, and general information about handling and taking care of the boat. The latest version of the manual is available in electronic format at the manufacturer's website.

Read the manual carefully and familiarize yourself with your boat before you start to use it. Also ensure that the anticipated wind and wave conditions correspond to the design category of your boat, and that you and your crew are able to handle the boat in these conditions.



This owner's manual is not a substitute for boating safety skills or good seamanship.

If this is your first boat or if this boat type is new to you, ensure you can handle the boat before you set out for the first time.

For information about local sea schools and approved instructors, please ask your boat dealer, the local boat clubs and national motorboat or yacht federations for advice. They can also provide information on specific local regulations on issues such as a driving licence or authorization, registration, insurance, and safety equipment.

This owner's manual is not a detailed maintenance or troubleshooting guide. If problems occur, contact the boat manufacturer or its local representative. When you are in need of maintenance or repair and alteration work, always turn to competent and trained professionals. Changes that can affect the boat's security features must be assessed, carried out and documented by competent professionals. The boat manufacturer cannot be held responsible for unauthorized modifications. Every change to the boat's center of gravity (from highly mounted heavy equipment or a new engine type etc.) significantly affects the stability, trim and performance of the boat.

Keep this manual in a safe place and pass it on to the new owner if you sell your boat. If the manual is mislaid or destroyed, a copy can be ordered from your dealer or downloaded from the manufacturer's website.

See the purchase agreement or order for the scope of your purchase. In case something does not work satisfactorily with your boat or its equipment, you can check the service documents for possible service and repair measures. If uncertain, always contact your dealer.

1.2 Safety symbols

This owner's manual contains danger, warning, caution and notice statements informing the user or authorized service representatives of any potential harm to the product or person.

Hazard is defined as a source of potential injury to a person.

All abnormal use is forbidden, including disregarding information on safety.

⚠ DANGER **Danger** indicates an imminently hazardous situation which, if not avoided, **will result in death or serious injury**.

⚠ WARNING **Warning** indicates a potentially hazardous situation which, if not avoided, **could result in death or serious injury**.

⚠ CAUTION **Caution** indicates a potentially hazardous situation which, if not avoided, **might result in minor or moderate injury**.

NOTICE **Notice** indicates a potential situation which, if not avoided, **might result in property damage or in an undesirable result or state**.



The information icon calls attention to information that clarifies or simplifies a procedure.

1.3 Document conventions

Units

This manual uses SI units in accordance with ISO 1000. In some cases, other units may have been used alongside.

An exception is the wind velocity, which in the Recreational Boat Directive is given in the Beaufort Scale.

Terminology

In this manual, the right side of the hull is referred to as starboard (STB) and the left side as port.

1.4 Copyright

Copyright ©2024 Axopar Boats. All rights reserved.

This Owner's Manual is protected by copyright controlled by Axopar Boats. This manual cannot be wholly or partly reproduced without prior written authorization by Axopar Boats. This material also contains confidential information, which may not be disclosed to others without the prior written consent of Axopar Boats.

1.5 Disclaimer

The material in this manual is for information purposes only.

Axopar Boats reserves the right to change the products without prior notice to improve reliability, function, design or other characteristics of the products. Axopar Boats assumes no liability for any damages, losses, costs or expenses arising out of or relating to the use of this manual or the products described herein.

Axopar Boats makes no representations and warranties with respect to this manual, either express or implied, including, but not limited to, the implied warranties of merchantability and fitness for a particular purpose.

1.6 Warranty

The Limited Warranty for the boat and the relevant contact information are enclosed as a separate document.

For any warranty claims, please contact your Axopar dealer mentioned on the cover page.

2 Safety

⚠ WARNING

The boat owner is responsible for making sure that the safety equipment on the boat meets the rules and regulations of the local authorities.

- Keep the necessary safety equipment up to date and on the boat at all times.

Check the preferred location of the major safety equipment in the section **Safety diagram**.

⚠ WARNING

Overloading the boat can damage the engine, even when shut off.

- When loading the boat, never exceed the maximum recommended load of the boat shown in the builder's plate.
- Always load the boat carefully and distribute loads appropriately to maintain design trim.
- Avoid placing heavy equipment or material high up in the boat.

The liquids in the built-in tanks are not included in the maximum load shown on the builder's plate.

⚠ WARNING

When out on the water, always use the seats intended for the passengers.

Do not exceed the maximum number of persons allowed in the boat, shown in the builder's plate.

The total weight of the persons on board and their personal luggage must never exceed the maximum load of the boat shown in the builder's plate.

⚠ CAUTION

Risk of personal injury and risk of damage to the roof or roof structures.

Do not place or attach any load or equipment on the roof or to the roof structures if there is no specific roof rack.

It is forbidden to enter the roof or dangle from the roof structures.

2.1 Safe and responsible boat operation

Please familiarize yourself to these safety aspects before using the boat. The person controlling the boat is in charge of the safety of all the passengers as well as other seafarers.

Neglecting these safety rules might lead to serious injury or death.

- Anyone who controls the boat must be competent to operate a boat of this type and size.
- The boat must not be controlled by an unqualified operator or by an operator under the influence of alcohol, drugs or other substance which impair judgement.
- The boat must always be operated at speeds that will not put people or property in danger.
- The captain must constantly be aware of conditions surrounding the boat when underway and especially before sharp turns.

- In challenging conditions such as rough water and winds, impaired visibility, and congested waterways; reduce speed, use appropriate navigation equipment and lights, and use a lookout to identify possible hazards.
- Pay attention to your wake. It can endanger smaller boats or damage moored boats or other property. You are responsible for damage caused by your wake.
- Only allow passengers to ride in areas that do not pose a hazard to themselves or the boat.
- Do not allow passengers to ride on aft folding seats, aft fender boxes or gunwales.
- Passengers must remain seated while the boat is moving.
- Use of alcohol, drugs, or other judgment-impairing substances poses a serious threat to yourself and others. The boat operator is responsible for the behavior of people on board.
- For every passenger on board, the boat must carry one wearable personal flotation device (PFD).

⚠ WARNING**Speed hazard**

This is a high-performance vessel; the speed of the craft needs to be adapted to the environment. To ensure your passengers' safety and comfort, avoid sharp turns in speeds exceeding 40 knots. Never operate your boat at speeds which exceed your ability to react to surprising and unpredictable situations. The captain is always responsible for operating the vessel in a safe way.

⚠ WARNING

Never operate a boat at a speed at which you do not feel comfortable.

⚠ DANGER**Slipping hazard**

Deck might be slippery when wet, even on non-skid areas. Be extremely cautious on slippery surfaces and wear suitable footwear.

⚠ DANGER

Do not go out boating in severe weather conditions as this might lead to serious injuries or death. Always get back to shore before the weather turns bad.

2.2 Safety diagram

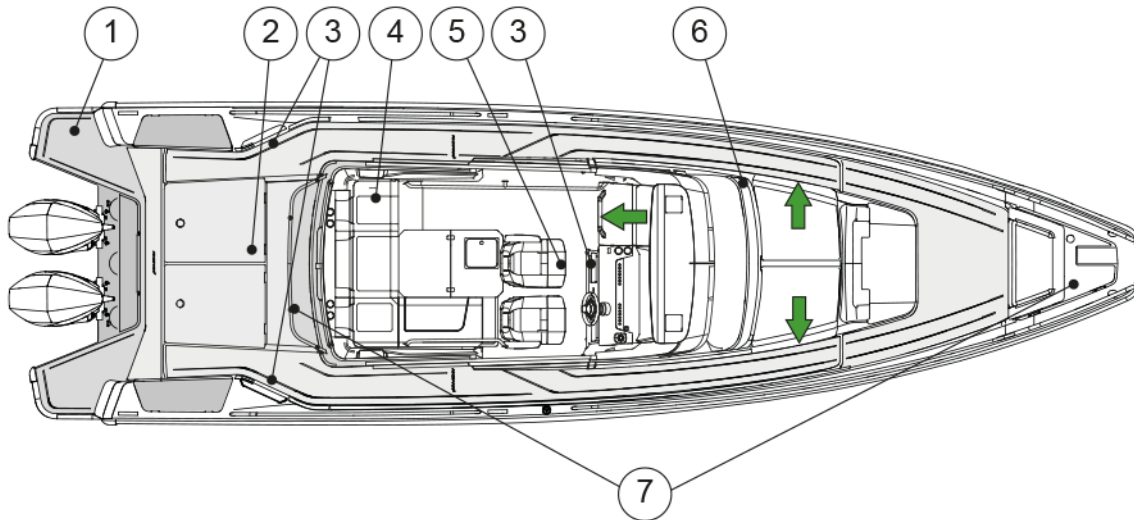

- (1) Swim ladder
- (2) Life raft storage
- (3) Fire extinguisher
- (4) Fire blanket
- (5) Main switch
- (6) Shut-off valve for LPG system
- (7) Gas cylinder
- Exit

2.3 Fire protection and control

The most common fire sources are the engine and the stove. If there is a fire in the boat, it may result in an explosion.

⚠ WARNING

Fire usually spreads very fast — be quick to extinguish the fire with the fire extinguisher on the boat!

See the section **Safety diagram** for the exact location of the fire extinguisher(s).

If the fire starts to get out of control, leave the burning boat to save lives.

⚠ WARNING

Always put down the fire by depriving the fire of oxygen.

Do not use water!

Using water in fire involving flammable liquids can spread the liquid and make the fire worse.

⚠ WARNING

If the fire reaches the fuel containers, an explosion may occur and cause a large area around the boat to burn.

- Keep the bilge clean and check it regularly for fuel and gas fumes or fuel and oil leaks.
- Do not hang curtains or other flammable material near or above the LPG cooker or other equipment with naked flames.
- Never leave the boat unattended when the cooker or heater is switched on.
- Never refuel or replace gas containers when the engines are running.
- Never smoke when handling fuel or gas.
- Never block evacuation routes or emergency exits.
- Never block access to safety equipment such as fuel valves or main power switches.
- Never block access to fire extinguishers, visible or concealed.
- Never modify the boat's systems (especially electrical, fuel or gas systems).

2.3.1 Fire control equipment

Check the exact locations of the fire control equipment in the section **Safety diagram**.

Fire extinguishers

You must fit the boat with a hand-held fire extinguisher with a fire rating of at least 13A/89B (2 kg).

Check the exact locations of the fire extinguishers in the section **Safety diagram**.



The fire extinguishers are not included in the manufacturer's delivery. Before using the boat, it must be furnished with fire extinguishers.

Fire blanket

A fire blanket is ideal for putting out small fires and also one of the best options if a person's clothes catch fire.

- Keep a fire blanket onboard in an easily accessible place.
- Keep a fire blanket beside the LPG cooker.

2.3.2 Boat owners' and users' responsibilities

It is your responsibility as the boat owner and user to ensure that the fire control equipment is accessible at all times.

- Check the fire extinguishing equipment regularly at the intervals specified for the equipment.
- Replace equipment with expired date immediately with equivalent or better equipment.
- Advise the crew and guests of the location and instructions for use of the fire control equipment, and the location of evacuation routes and emergency exits.

2.3.3 Checklist: Fire in the engine

- Stop the engine.
- Steer the boat up against the wind, if possible.
- Make sure all passengers have life jackets.
- If necessary:
 - Evacuate the passengers.
 - Call for sea rescue.
- Shut off fuel, LPG and main power switches.
- Extinguish the fire.
- Wait until fully certain that the fire has been extinguished before opening the engine cover.
Carefully open the engine cover and be prepared to use the handheld fire extinguisher if necessary for post-fire extinguishing.
- Put out possible smoldering fires with water.

2.3.4 Checklist: After fire

- Open doors and windows for better ventilation.
- Inspect the boat and its equipment, and repair any damages.
- Contact local authorities, if needed.
- Make sure that the fire extinguishing equipment is refilled or replaced after use.

2.4 Carbon monoxide

WARNING

Carbon monoxide (CO) is colorless, odorless, tasteless, and extremely dangerous gas.

All engines, generators, and fuel burning appliances produce CO as exhaust.

Prolonged exposure to low concentrations or very quick exposure to high concentrations may cause brain damage or death.

Open all doors, curtains, windows, and hatches to let fresh air circulate when running an engine or generator or burning any fuel while the boat is anchored, moored or docked.

If you can smell engine or generator exhaust, you are inhaling CO. CO can also be present without the smell of exhaust fumes.

⚠ WARNING

If the CO alarm is activated, make sure all persons onboard exit the closed spaces.

- If exhaust fumes are detected or if CO accumulation is suspected on the boat, take immediate action to ventilate these fumes.
- Turn off all engines and generators.
- Open all hatches, windows and ports to ventilate.

Changing course and speed to place the boat heading into the wind can improve ventilation.

Symptoms of carbon monoxide poisoning are dizziness, ears ringing, headache, nausea and unconsciousness. A poisoning victim's skin often turns cherry red.

Because the carbon monoxide gas is odorless, colorless and tasteless, it is unlikely to be noticed until a person is affected.

⚠ DANGER

- If CO poisoning is suspected, have the victim breath fresh air deeply.
- If breathing stops, resuscitate.
- A victim often revives, but then relapses because organs are damaged by the lack of oxygen.

Seek immediate medical attention.

High levels of carbon monoxide may accumulate in the following ways:

- Blocking hull exhausts while operating at slow speed or if exhausts are submerged.
- Using canvas curtains.
- Winds blowing exhaust toward boat occupants.
- Operating engine or generator in a confined space.
- Operating with the bow high.

Dangerous concentrations of carbon monoxide are present if:

- the engine or generator exhaust systems leak
- insufficient fresh air is circulating where people are present
- fumes move from the rear of the boat into the cockpit and cabin area.



To minimize the danger of CO accumulation when the engine and generator are running or when using burning fuel applications:

- Be sure to have sufficient ventilation when using canvas or window-type side curtains when underway, anchored, moored or docked.
- Operate all burning fuel appliances, such as charcoal, propane, LPG, CNG or alcohol cooking devices, in areas where fresh air can circulate. Do not use such devices where there is no noticeable air movement, especially in the cabin, when anchored, moored or docked.
- Do not idle the engine without moving the boat for more than 15 minutes at a time.
- Inspect the exhaust system regularly. See the manufacturer's manual for instructions.

2.5 Carbon monoxide monitor

There is a carbon monoxide monitor system in the boat.

The carbon monoxide monitors are located in all accommodation areas of the boat.

- With regular intervals, check that the monitor system is functioning. For instructions, see the equipment manufacturer's manual.
- It is not possible to turn the CO monitor off when the boat is in use.

See here the description of the audible and visual signals of the monitor.



Low battery voltage can trigger the carbon monoxide monitor to sound an alarm.

Operation	Audible Signal	Visual Signal
Normal	None	Green led flashes every minute
CO alarm	4 beeps, 5 seconds off - cycle repeats	Flashing red
Alarm malfunction	Beep every 30 seconds	Alternating red/green flash
End of life signal	Beep every 25-30 second	Red red green green flash sequence

2.6 Smoke alarm

Boat is equipped with smoke alarms.

Smoke alarm is battery powered. When the battery level reaches low level, the smoke alarm will start emitting low battery warning signal.

Smoke alarm may give false alarm if there is steam, condensation, or normal smoke or fumes in its vicinity.

The smoke alarm has a built-in hush or silence feature incorporated into the test button. This feature can be useful when unwanted alarm is caused by cooking or other non-hazardous sources trigger the alarm. Hush or silence feature temporarily silences the alarm and can be activated by pressing the test button for approximately 1 second. When hush or silence feature is activated, the alarm will enter dormant mode for 10-minute period with reduced sensitivity. Reduced sensitivity is indicated by red LED flashing every 10 seconds. After the period is over, the device will signal returning to normal sensitivity with two short beeps. If smoke density increases during hush or silence period, the device will automatically return to alarm mode.

Smoke alarms should be replaced at minimum every 5 years.

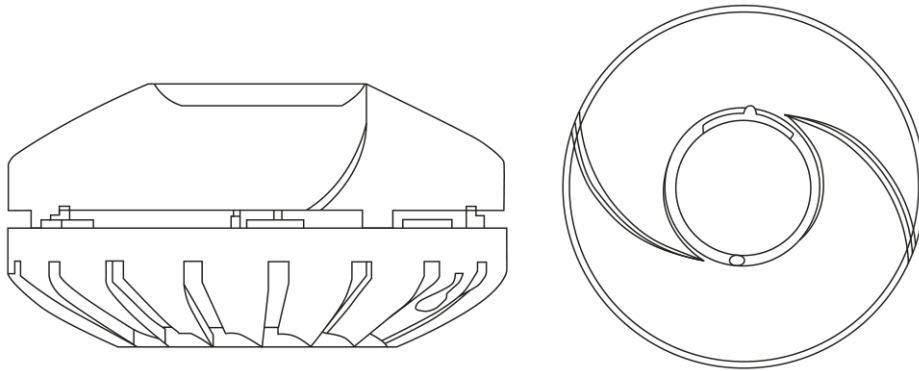

Figure 2.1 Smoke alarm

2.7 Life raft

The boat is not equipped with a life raft by the manufacturer.

Storing a life raft

If you decide to acquire a life raft for your boat, stow it to the aft of the boat, so that it is easily accessible in case of emergency.

Using the life raft

The life raft must be tied to the stern of the boat and prepared for use.



In an emergency, it is easiest and safest to board the life raft from the swimming deck. Switch off the engine before using the life raft.



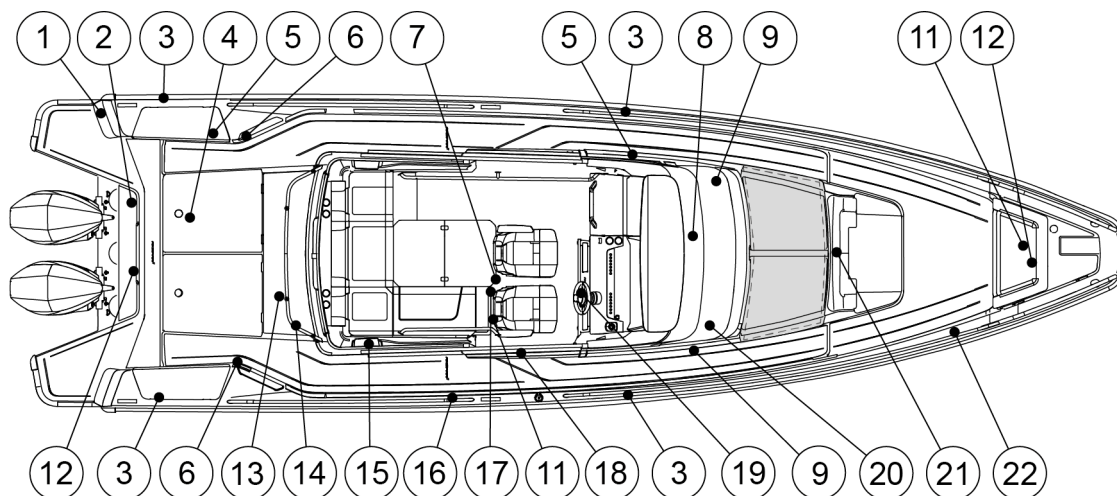

Follow the life raft manufacturer's instructions.

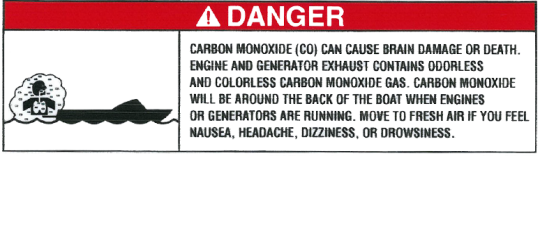

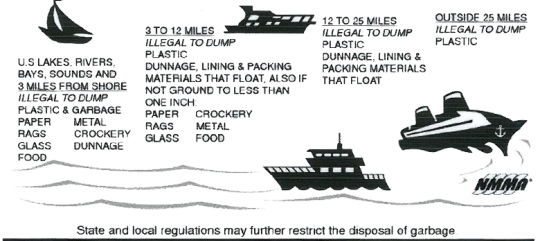



2.8 Safety labels on board



The following picture and table present the location and description of the safety labels on board.

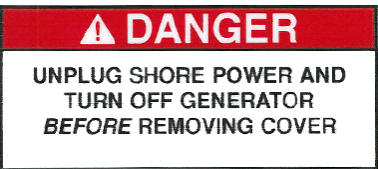





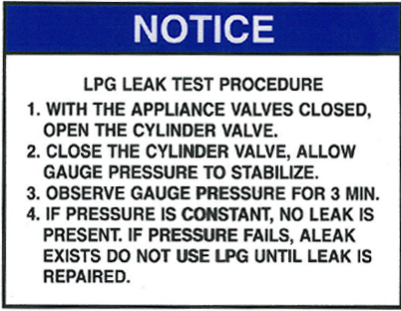
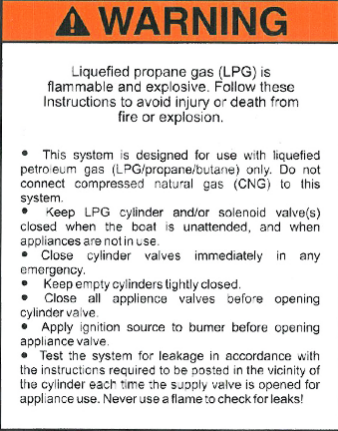

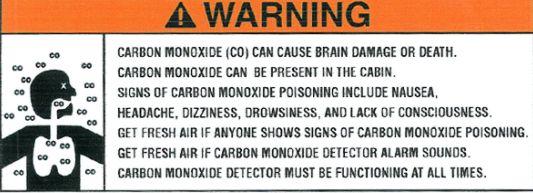

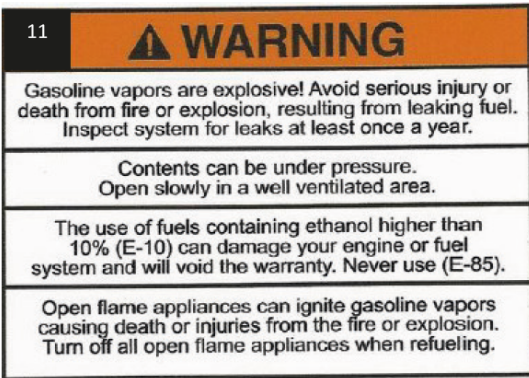

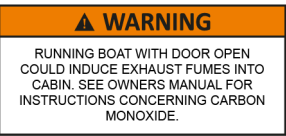
Position	Label	Description
1		<p>Danger</p> <p>Contact with spinning propeller will cause serious injury or death.</p> <p>Saty clear of boat and stay off swim platform and boarding ladder while engine is running.</p>
1		<p>Danger</p> <p>Carbon monoxide (CO) can cause brain damage or death. Engine and generator exhaust contains odorless and colorless carbon monoxide gas. Carbon monoxide will be around the back of the boat when engines or generators are running. Move to fresh air if you feel nausea, dizziness, or drowsiness.</p>
2	<p>DISCHARGE OF OIL PROHIBITED</p> <p>THE FEDERAL WATER POLLUTION CONTROL ACT PROHIBITS THE DISCHARGE OF OIL OR OILY WASTE INTO OR UPON THE NAVIGABLE WATERS OF THE UNITED STATES, OR THE WATERS OF THE CONTIGUOUS ZONE, OR WHICH MAY AFFECT NATURAL RESOURCES BELONGING TO, APPERTAINING TO, OR UNDER THE EXCLUSIVE MANAGMENT AUTHORITY OF THE UNITED STATES, IF SUCH DISCHARGE CAUSES A FILM OR DISCOLORATION OF THE SURFACE OF THE WATER OR CAUSES A SLUDGE OR EMULSION BENEATH THE SURFACE OF THE WATER. VIOLATORS ARE SUBJECT TO SUBSTANTIAL CIVIL PENALTIES AND/OR CRIMINAL SANCTIONS INCLUDING FINES AND IMPRISONMENT.</p> 	<p>Discharge of oil prohibited</p> <p>The federal water pollution control act prohibits the discharge of oil or oily waste into or upon the navigable waters of the United States, or the waters of the contiguous zone, or which may affect natural resources belonging to, appertaining to, or under the exclusive management authority of the Unites States, if such discharge causes a film or discoloration of the surfaces of the water or causes a sludge or emulsion beneath the surface of the water. Violators are subject to substantial civil penalties and/or criminal sanctions including fines and imprisonment.</p> <p>NMMA</p>
2	<p>LIQUIDS HERE IT IS ILLEGAL FOR ANY VESSEL TO DUMP PLASTIC TRASH ANYWHERE IN THE OCEAN OR NAVIGABLE WATERS OF THE UNITED STATES. ANNEX V OF THE MARPOL TREATY IS AN</p> <p>INTERNATIONAL LAW FOR A CLEANER, SAFER MARINE ANVIROMENT. VIOLATION OF THESE REQUIREMENTS MAY RESULT IN CIVIL PENALTY UP TO \$25,000, FINE AND IMPRISONMENT.</p>  <p>State and local regulations may further restrict the disposal of garbage</p>	<p>Liquids here. It is illegal for any vessel to dump plastic trash anywhere in the ocean or navigable waters of the United States. Annex V of the Marpol Treaty is an international law for a cleaner, safer marine anviroment., Violation of these requirements may result in civil penalty up to \$25,000, fine and imprisonment. U.S. lakes, rivers, bays, sounds and 3 miles from shore Illegal to dump plastic & garbage, paper, metal, rags, crockery, glass, dunnage, food.</p> <p>3 to 12 miles Illegal to dump plastic, dunnage, lining & packing materials that float. Also if not ground to less than one inch: paper, crockery, rags, metal, glass, food</p> <p>12 to 25 miles illegal to dump plastic, dunnage, lining & packing materials that float</p> <p>Outside 25 miles illegala do dump plastic</p> <p>State and local regulations may further restrict the disposal of garbage.</p>

Position	Label	Description
3		Fastening point
4	<div style="border: 1px solid black; padding: 5px;"> <p style="text-align: center;">⚠ WARNING</p> <p style="text-align: center;">Installation of Maintenance free AGM batteries are only allowed in this area.</p> </div>	<p>Warning</p> <p>Installation of maintenance free AGM batteries are only allowed in this area.</p>
5		Sink drain shutoff valve
6		Fire extinguisher
7	<div style="border: 1px solid black; padding: 5px;"> <p style="text-align: center;">⚠ WARNING</p> <p style="text-align: center;">AVOID SERIOUS INJURY OR DEATH. UNEXPECTED SEAT ROTATION MAY CAUSE EJECTION OF OCCUPANT.</p> <p style="text-align: center;">LOCK SWIVEL WHEN SPEED EXCEEDS 5 MPH.</p> </div>	<p>Warning</p> <p>Avoid serious injury or death. Unexpected seat rotation may cause ejection of occupant.</p> <p>Lock swivel when speed exceeds 5 mph.</p>
8		Waste tank shutoff valve
9	<div style="border: 1px solid black; padding: 5px;"> <p style="text-align: center;">⚠ WARNING</p> <p style="text-align: center;">DOOR MUST BE SECURED WHILE VESSEL IS UNDERWAY.</p> </div>	<p>Warning</p> <p>Door must be secured while vessel is underway.</p>

Position	Label	Description
9		Emergency exit
9		Warning Keep shut while underway.
10		Danger Unplug shore power and turn off generator before removing cover.
11		Pay attention to the warnings and read the manual.
12		Warning Ski pole must be secured when in use. Tow rope may backlash into cockpit. Do not use to tow items such as tubes or other towables. Max tow load capacity is 130 kg.
13		Notice LPG working pressure Butane: 28mbar Propane: 37mbar
13		LPG shutoff valve

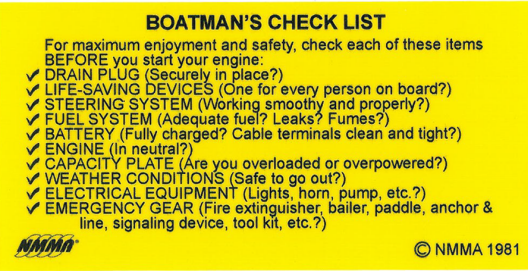
Position	Label	Description
13		<p>Notice</p> <p>LPG leak test procedure</p> <ol style="list-style-type: none"> 1. With the appliance valves closed, open the cylinder valve. 2. Close the cylinder valve, allow gauge pressure to stabilize. 3. Observe gauge pressure for 3 min. 4. If pressure is constant, no leak is present. If pressure fails, a leak exists. Do not use LPG until leak is repaired.
13		<p>Warning</p> <p>Liquefied propane gas (LPG) is flammable and explosive. Follow these instructions to avoid injury or death from fire or explosion.</p> <ul style="list-style-type: none"> • The system is designed for use with liquefied petroleum gas (LPG/propane/butane) only. Do not connect compressed natural gas (CNG) to this system. • Keep LPG cylinder and/or solenoid valve(s) closed when the boat is unattended, and when appliances are not in use. • Close cylinder valves immediately in any emergency. • Keep empty cylinders tightly closed. • Close all appliance valves before opening cylinder valve. • Apply ignition source to burner before opening appliance valve. • Test the system for leakage in accordance with the instructions required to be posted in the vicinity of the cylinder each time the supply valve is opened for appliance use. Never use a flame to check for leaks!
14		<p>Warning</p> <p>Do not close the wetbar lid until the grill has completely cooled down.</p>
15		<p>Warning</p> <p>Carbon monoxide (CO) can cause brain damage or death. Engine and generator exhaust contains odorless and colorless carbon monoxide gas. Signs of carbon monoxide poisoning include nausea, headache, dizziness, drowsiness, and lack of consciousness. Get fresh air if anyone shows signs of carbon monoxide poisoning. See owner's manual for information regarding carbon monoxide poisoning.</p>

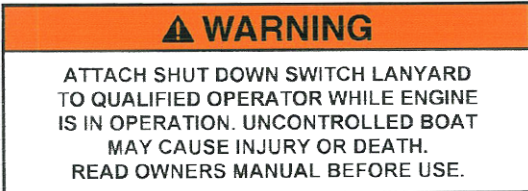
Position	Label	Description
16		<p>Warning</p> <p>Gasoline vapors are explosive! Avoid serious injury or death from fire or explosion, resulting from leaking fuel. Inspect system for leaks at least once a year.</p> <p>Contents can be under pressure. Open slowly in a well ventilated aread.</p> <p>The use of fuels containing ethanol higher than 10% (E-10) can damage your engine or fuel system and will void the warranty. Never use (E-85).</p> <p>Open flame appliances can ignite gasoline vapors causing death or injuries from the fire or explosion. Turn off all open flame appliances when refueling.</p>
17		<p>Caution</p> <p>If switch is turned off while engine is running alternator will be damaged.</p>
18		<p>Warning</p> <p>Running boat with door open could induce exhaust fumes into cabin. See owners manual for instructions concerning carbon monoxide.</p>
19		<p>Warning</p> <p>Use caution with skier in tow as tow rope may backlash into cockpit when released.</p>
19		<p>NMMA certificate</p>
19		<p>Certification plate US</p> <p>Design compliance with NMMA requirements and US Coast Guard safety standards.</p> <p>Meets EVAP standards using certified components.</p>

Position	Label	Description
19		<p>Warning</p> <p>Qualified operator to be in control at all times. Operation by an unqualified operator can cause loss of control. This may result in severe injury, death, or property damage. Boat stability and handling will change with weight distribution.</p> <p>Read owners manual before use.</p>
19		<p>Boatman's checklist</p> <p>For maximum enjoyment and safety, check each of these items before you start your engine:</p> <ul style="list-style-type: none"> - Drain plug (Securely in place?) - Life-saving devices (One for every person on board?) - Steering system (Working smoothly and properly?) - Fuel system (Adequate fuel? Leaks? Fumes?) - Battery (Fully charged? Cable terminals clean and tight?) - Engine (In neutral?) - Capacity plate (Are you overloaded or overpowered?) - Weather conditions (Safe to go out?) - Electrical equipment (Lights, horn, pump, etc.?) - Emergency gear (Fire extinguisher, bailer, paddle, anchor & line, signaling device, tool kit, etc.?)
19		<p>Warning</p> <p>Contact with spinning propeller will cause serious injury or death.</p> <p>Shut off engines while people are in the water near the boat, on the swim platform, or on the boarding ladder.</p> <p>Never operate in reverse toward a person in the water.</p>
19		<p>Warning</p> <p>Attach shut down switch lanyard to qualified operator while engine is in operation. Uncontrolled boat may cause injury or death.</p> <p>Read owners manual before use.</p>
19		<p>Fore and aft sun pads should not be used when vessel is under way.</p>

Position	Label	Description
19		Press to unlock gas spring.
20		<p>Warning</p> <p>Carbon monoxide (CO) can cause brain damage or death.</p> <p>Carbon monoxide can be present in the cabin.</p> <p>Signs of carbon monoxide poisoning include nausea, headache, dizziness, drowsiness, and lack of consciousness.</p> <p>Get fresh air if anyone shows signs of carbon monoxide poisoning.</p> <p>Get fresh air if carbon monoxide detector alarm sounds.</p> <p>Carbon monoxide detector must be functioning at all times.</p>

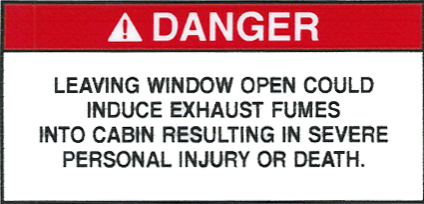
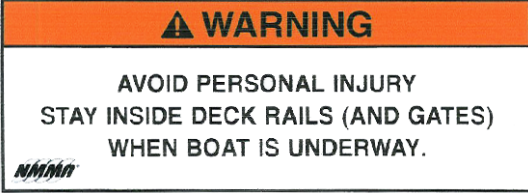
Position	Label	Description
21		<p>Danger</p> <p>Leaving window open could induce exhaust fumes into cabin resulting in severe personal injury or death.</p>
21	<p>WARNING WATERTIGHT CLOSURE KEEP SHUT WHEN UNDER WAY</p>	<p>Warning</p> <p>Watertight closure. Keep shut when underway.</p>
22		<p>Warning</p> <p>Avoid personal injury. Stay inside deck rails (and gates) when boat is underway.</p>

3 Product overview

3.1 Purpose of use

The boat is a recreational boat, thus not suitable for professional use.

3.2 Identification

Each boat has a unique identification code, containing 14 characters and a hyphen.

The height of the code text is 6 mm, and it is located on the starboard side of the stern.

Example: FI – AXO7A001F920	Data
FI	Country of manufacturer: Finland
-	Hyphen
AXO	Manufacturer: Axopar Boats
7A	Boat model <ul style="list-style-type: none"> • A = S Spyder • B = ST Sun-Top • C = XC Cross Cabin
001	Boat number
F	Manufacturing month <ul style="list-style-type: none"> • A = January • B = February • C = March • etc.
9	Last digit of the manufacturing year
20	Model year

3.3 Builder's plate

The builder's plate is always located close to the steering position of the boat.

Eurofins Expert Services Oy has inspected that the boat fulfills the Recreational Boat Directive and related standards' requirements.

The builder's plate contains the following information:

- Boat model
- Manufacturer's address
- Maximum number of persons on board
- Maximum load: total weight of persons including personal luggage and basic equipment, and excluding tank contents

3.4 CE certification

This boat is classified to CE categories B and C.

The category is determined according to the maximum number of persons allowed onboard.

The CE certification indicates that a boat is designed and built in such a way that it retains its stability and buoyancy in given circumstances and meets other important requirements that are characteristic of the category in question. One of these requirements is that the boat must be easy to maneuver.

The CE categories classification also signifies that a boat is designed and constructed to withstand the following parameters in respect of stability, buoyancy, and other relevant essential requirements stated.

Category	Description
A. Ocean	The boat is designed for extended voyages, where conditions experienced may exceed wind force 8 on Beaufort Scale and include significant wave heights of at least 4 meters. Under such conditions, the boat must be largely self-sufficient.
B. Offshore	The boat is designed for offshore voyages, where conditions up to and including wind force 8 on Beaufort Scale and significant wave heights up to and including 4 meters may be experienced.
C. Inshore	The boat is designed for voyages in coastal waters, large bays, estuaries, lakes and rivers, where conditions up to and including wind force 6 Beaufort Scale and significant wave heights up to and including 2 m may be experienced.

3.5 Dimensions and weight

Dimensions

Dimension	SI units	US units
Hull length (LH)	11.5 m	37 ft 9 in
Overall length (LMAX) (excluding engine)	11.5 m	37 ft 9 in

Dimension	SI units	US units
Hull beam (BH)	3.4 m	10 ft 10 in
Draught at max. load (excluding engine)	0.9 m	2 ft 8 in
Height measured from waterline at light load	3.1 m	10 ft 5 in (with light mast 86 cm)

Power

	SI units	US units
Maximum recommended engine power	2 x 298 kW	2 x 400 hp

Weight and loading

	SI units	US units
Hull weight (excluding engine)	4181 kg	9218 lb

	Category B	Category C
Maximum number of persons	10	12
Default weights:		
• Adult: 75 kg		
• Child: 37.5 kg		

	Category B		Category C	
	SI units	US units	SI units	US units
Total weight of all persons	750 kg	1653 lb	900 kg	1984 lb
Weight of unloaded boat with maximum weight outboard engines	4448 kg	9806 lb	4697 kg	10355 lb
Maximum recommended load	2247 kg	4954 lb	2397 kg	5285 lb
Boat weight at maximum load	6695 kg	14760 lb	7094 kg	15640 lb

of which

	SI units	US units
Maximum recommended engine weight	750 kg	1653 lb
Personal luggage	200 kg	441 lb
Fresh water	95 kg	209 lb
Septic water	80 kg	176 lb
Fuel	556 kg	1226 lb
Optional equipment and fittings	566 kg	1248 lb
Life raft weight	40 kg	89 lb
Total weight of fuel, water and other liquids	1297 kg	2859 lb
Mass on trailer	4928 kg	10864 lb

Tank capacity

	SI units	US units
Fuel tank	730 l	193 gal
Fresh water tank	95 l	25 gal
Septic tank	80 l	21 gal

The boat's stability assessment is based on maximum load conditions.

The maximum recommended load only contains the weight components mentioned above.

3.6 Boat layout

The boat has several deck options. The layout of the equipment and the technical components may vary depending on the selected accessories.

The standard boat has an open aft deck equipped with an aft-facing perch.

The front cabin of the boat can be equipped with gullwing doors.

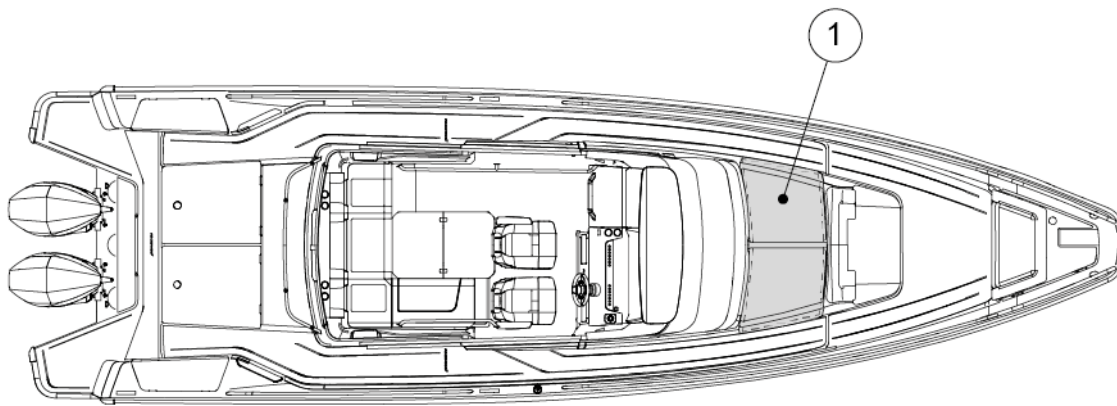

(1) Gullwing doors

The boat can be equipped with an aft cabin, an aft bench with storage, a wet bar, a U-sofa or a multi-storage.

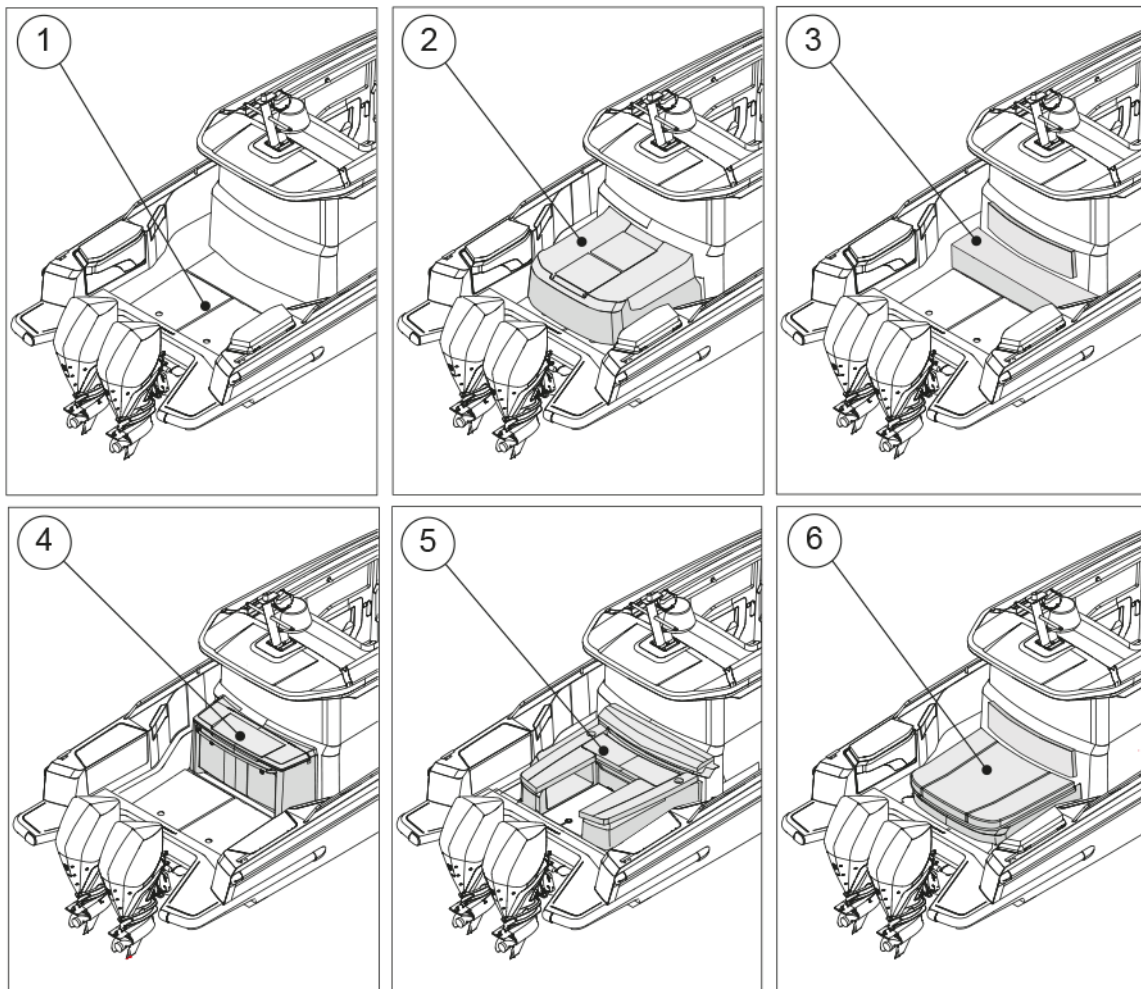

- (1) Open aft
- (2) Aft cabin
- (3) Aft bench with storage
- (4) Wet bar
- (5) U-sofa
- (6) Multi-storage

4 Product description

4.1 Stability and buoyancy

Pay attention to the stability and buoyancy of the boat.

All weight dispositions (for example installing a fishing tower or radar, and engine replacement) can have a significant impact on the stability, trim, and performance of the boat.

- The bilge water level needs to be kept at a minimum.
- The stability of the boat is compromised if any weight is placed in a high position.

In stormy weather, all hatches, compartments and doors must be kept closed to minimize the risk of flooding.

Breaking waves represent a significant danger to stability.

⚠ WARNING

To avoid the risk of flooding, always keep the seacocks closed when not in use (for example, the seacock for the toilet's flushing water).

4.1.1 Self-draining systems

The boat is equipped with self-draining systems for the whole deck area. The system is drained through drain holes in the aft of the boat. In addition to rainwater, the drain holes are intended to drain water ending up on the deck through splashing or from breaking waves.

There are drain holes for water in both aft corners of the deck. The openings are directly connected to the sea. The deck of the boat has been designed to allow the water to drain straight into the sea via the water gullies.

⚠ CAUTION

Do not close the drain holes when using the boat.

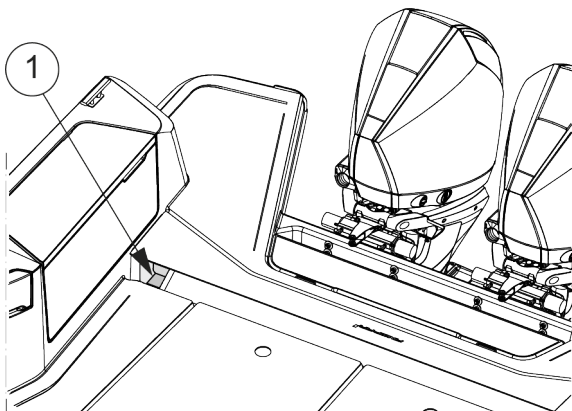

(1) Drain hole

The drain holes must be open at all times. Clean the holes regularly by removing any accumulated debris to prevent clogging.

The system is built so as to drain the water from the deck in normal use. Do not close the taps when using the boat or when the boat is attached to the dock.

There is a recess under the front seats which is separately drained. There are two drains on aft corners of the recess. Recess drains via seacocks which are located on hull sides of the boat. Access to valves for the seacocks are from inspection hatch next to drains.

NOTICE

The self-emptying open space is meant for the removal of such water that ends up on the deck through rain, splashing or from breaking waves. A part of the rain water as well as water condensation in the bilge may end up in the bilge.

- Do not leave the boat unattended in the water for a long time.
- Observe the floating position of the boat and empty the bilge when necessary.

Leaving the boat unattended in the water for a long time may cause damage.

4.1.2 Openings in the hull and deck

There are several inlets through the boat that include valves for opening and closing such inlets. It is recommended to keep these inlets closed if the boat is out of use for a long time, and to open them again when the boat is used again. If the boat is lifted out from water or in rainy conditions, inlets should be kept open.

Always check that all hatches are securely closed before and after using the boat.

We recommend that you keep the windows, doors, deck hatches, roof hatches, vents and interior doors closed while driving. In stormy weather, always keep them securely closed to minimize the risk of water getting into the boat and to avoid any personal injuries.

In certain conditions and speeds, it is possible that water is sprayed inside through canopies, hatches or other openings, due to negative pressure or other effects. Risk for this can be minimized by closing the canopies, hatches or other openings.

⚠ WARNING

All doors and hatches must be kept shut when under way.

The figure shows the hatches and seacocks that must be kept closed when the boat is left unattended. Keep hatches closed also while underway.

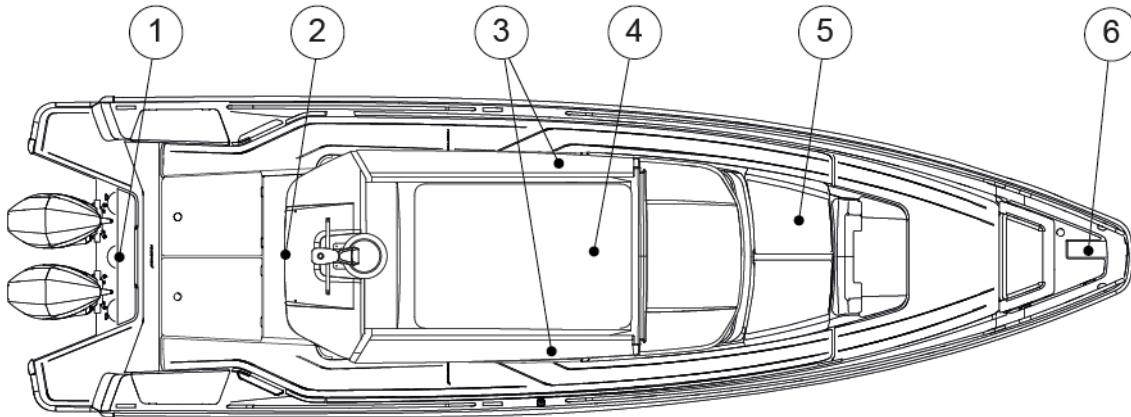

- (1) Inspection hatch of the engine bracket
- (2) Aft cabin roof hatches or multistorage hatches
- (3) Main cabin door
- (4) Roof hatch
- (5) Gullwing doors of front cabin
- (6) Storage box hatch

The location and number of these components depend on the level of the equipment on the boat.

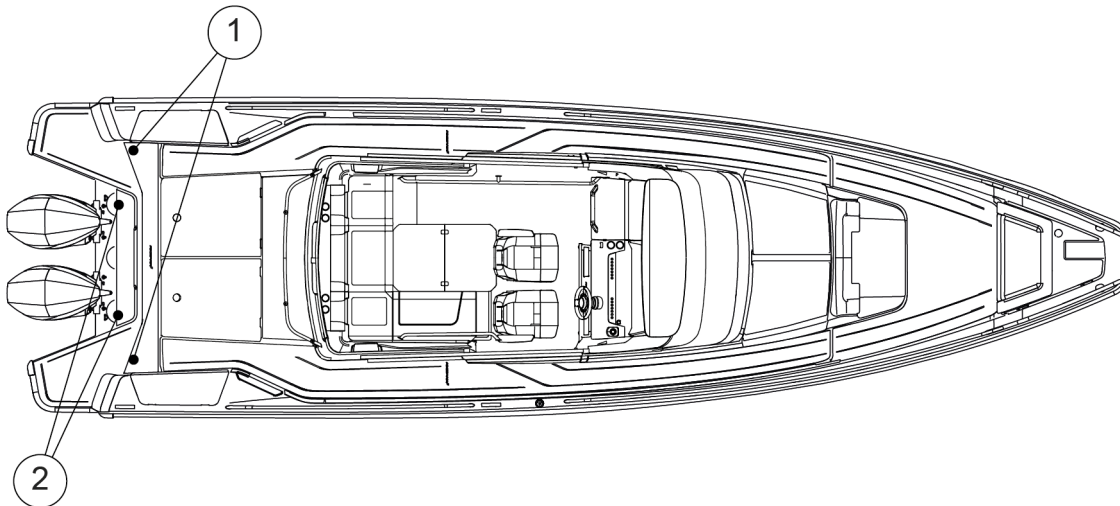

- (1) Outlet of aft deck and cockpit draining seacocks
- (2) Outlet seacocks of cockpits

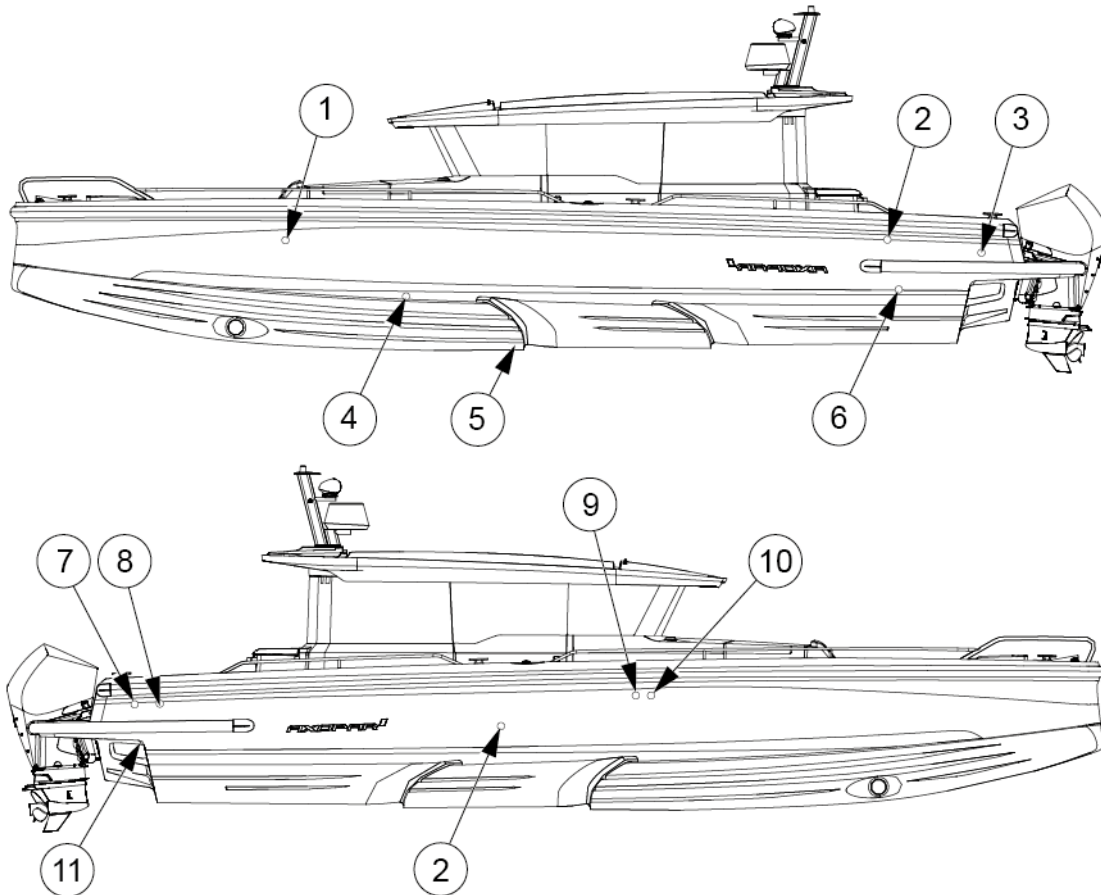

- (1) Fresh water tank ventilation
- (2) Fuel tank ventilation
- (3) Manual bilge pump outlet
- (4) Front cabin sink outlet
- (5) Toilet seat water inlet
- (6) Wet bar sink outlet
- (7) Aft bilge pump outlet
- (8) Heater fuel tank ventilation
- (9) Septic tank ventilation
- (10) Bow bilge pump outlet
- (11) Aft deck and cockpit draining seacocks

4.1.3 Bilge system

The bilge system is designed to enable keeping the bilge water level at a minimum. The system consists of several pumps that cover all the lower sections of the boat.

The boat is equipped with both manual and electric bilge pumps. The signs on the boat display the draining area of each pump.

The manual bilge pump is controlled with its handle.

The submersible electric bilge pumps are equipped with a float which triggers them automatically if there is water in the bilge space. The electric bilge pumps can also be controlled manually from the switches on the steering console.

⚠ WARNING

The bilge system is not designed for damage control.

The combined capacity of the bilge system is not designed to pump out the boat in the event of hull damage.

NOTICE

Keep the bilge area clean by washing it ever so often using bilge cleaner or biodegradable soap and water. Clean bilge significantly helps noticing signs of leaks or other problems that may occur.

NOTICE

- Check the functionality of the bilge pumps regularly by manually activating them.
- Remove any waste from the intakes.
- Clear the pump outlets from debris.

If seacocks are fitted in the fore and aft peak bulkheads, keep them closed, and only open to let water drain into the main bilges.

NOTICE

Do not run the pumps dry for a long time. The pumps will be damaged.

NOTICE

Avoid pollution.

Since the bilge system comprises of several automatic and manual pumps that cover all areas of the boat, the risk of accidental discharge of contaminated water by automatic pumps needs to be minimized.

Mitigate the risk by checking the bilge water regularly for contaminants such as oil, diesel, and glycol.

Before every use

Make sure that:

- The bilge pumps can operate freely, and there are no objects blocking operation.
- Water can flow through the strainer, and there is no muck or material restricting the water flow.
Clean the strainer by pushing the lock tabs in the pump motor and lifting the motor unit off.

4.1.3.1 Bilge pumps and outlets

Bilge pump output

- The manual bilge pump output is 33 liters (9 gallons) per minute.
- The automatic bilge pump output is 41 liters (11 gallons) per minute.

Bilge pump locations

The manual bilge pump's control handle is located in the port side stowage casing of the aft deck.

The electric bilge pumps are submersible. One electric bilge pump is located under the berth of the aft cabin or under the storage hatch. Another electric bilge pump is located under the front cabin floor.

The electric bilge pumps are by default in the automatic mode and pump out the bilge once the float-switch is triggered. The electric bilge pumps can also be started manually from the boat's main control panel.

One bilge pump is located in the technical space. It is operated from the technical space control panel.

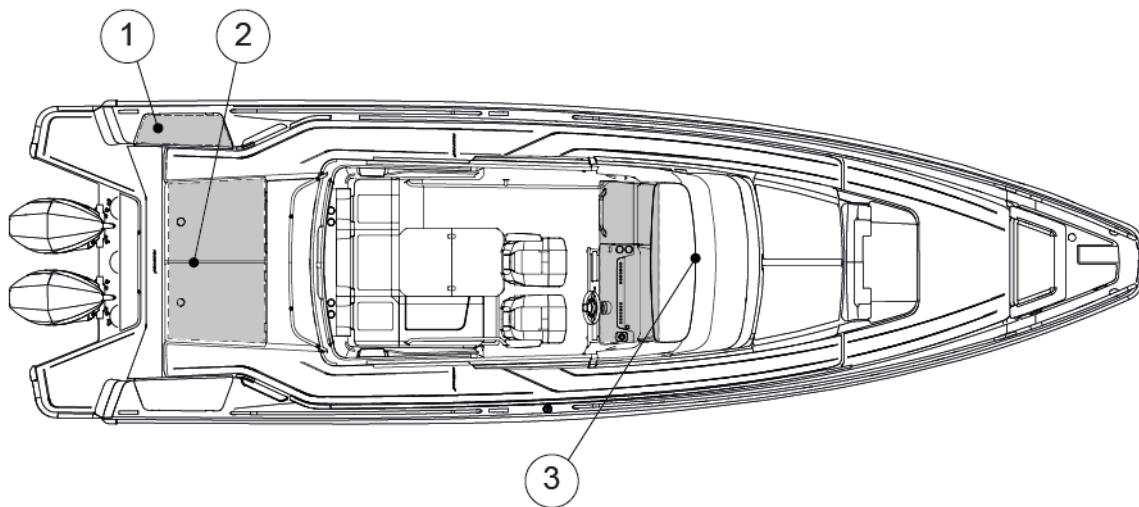

- (1) Manual bilge pump
- (2) Aft electric bilge pump
- (3) Front electric bilge pump

Bilge pump outlets

The figure shows the bilge pump outlets through the side. Always check in the spring when launching that the outlets through the side and bottom are tightly closed.

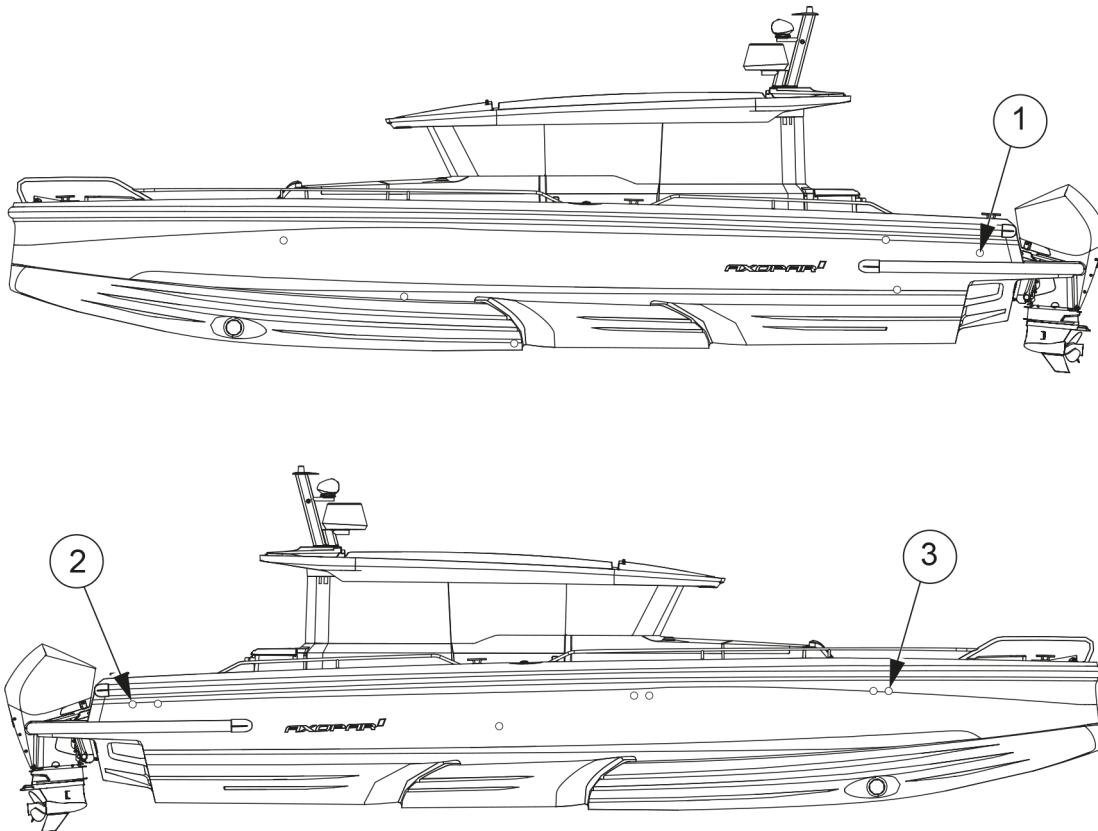

- (1) Manual bilge pump outlet
- (2) Aft bilge pump outlet
- (3) Bow bilge pump outlet

4.2 Technical systems

4.2.1 Electrical system

⚠ WARNING

Risks of fire, explosion and electric shock!

Improper use of electric DC and AC systems may result in fire or explosion.

Improper use of electric AC systems may result in electric shock.

Follow the instructions carefully.

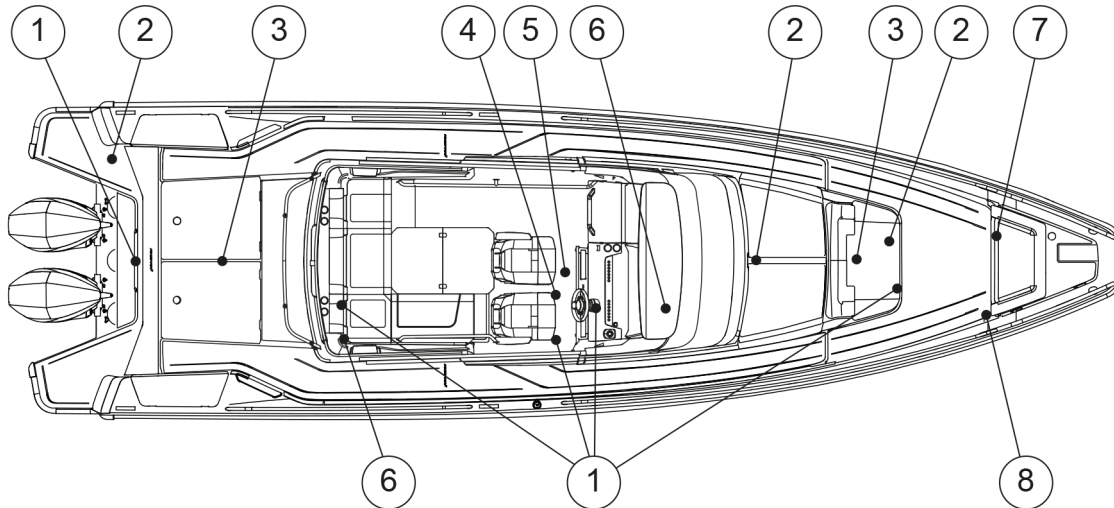

- (1) 12 V output
- (2) High-current fuses
- (3) Batteries
- (4) 230 V socket
- (5) Remote controlled main switches
- (6) Fuse panel
- (7) Shorepower charger and fuses
- (8) Shorepower socket

4.2.2 12V system

Most of the boat's equipment uses the 12 V system.

The 12V system consists of engine driven alternators, battery chargers for shore-side electricity, batteries and equipment. The power is supplied to the batteries via diodes from either the engine alternator or the shore power charger.

To activate the circuits in the 12V system, the main switches for the corresponding circuits need to be activated and the fuses intact. When the electronic circuit is switched on, the equipment can be operated from the main switch panel.

⚠ WARNING

- Never switch off the main switch when the engine is running, because this may cause damage to the alternator.
- Never carry out electrical installations when the power is switched on.
- Never modify the boat's electrical system or diagrams. Service and maintenance must be carried out by a qualified electrician.
- Never alter or modify the rated amperage of the overcurrent protective devices.
- Never install or replace electrical equipment with components that cause the circuit's nominal rated amperage to be exceeded.
- Never leave the boat unattended with the electrical system energized, except automatic bilge pump, fire protection, and alarm circuits.
- Maintain any damaged equipment before taking it back to use.

4.2.3 Main switches

The different electronic circuits of the boat are controlled by the main switches.

The main switches allow the batteries to be disconnected from all devices that consume electricity. When the main switches are in the On position, the current is conducted to the distribution board and from there to different parts of the boat.

When the main switches are active, the text "On" is visible and a led above the text is illuminated.

Devices that constantly need current are active regardless of the position of the main switches.

The design drawing of the boat's electrical system is presented in **Appendix II**. The location of the main switches is presented in the section **Electric system**.

The main switches of the boat are located in the driver's seat base. Power supply to the engines and devices is enabled by pulling the Start or Service switch to the lower position and pressing the On button. There is a main switch for each engine and one switch for the service batteries. The optional bow thruster or windlass has a separate remote switch. The boat's main switch panel is located on the lower part of the steering console.

The manually operated main switches are located under the aft deck, behind hatches. These switches are only for emergency use. In normal situations, use the switches in the steering console.

Current is fed to the engine by turning the Start switch to the On position. The current feed to other equipment is achieved by turning the Service switch to the On position, and feed to the bow thruster and windlasses is achieved by turning the Aux switch to the On position.

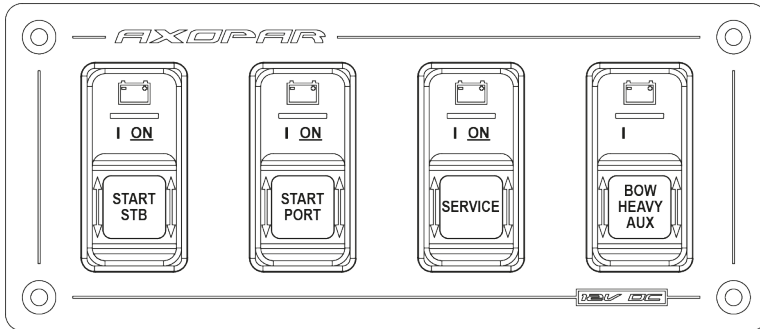

- (1) Starboard (STB) engine
- (2) Port engine
- (3) Service
- (4) Heavy Aux

4.2.4 Direct supply fuses

Some of the devices in the boat are supplied by direct supply switches. Direct supply switches are intended for such equipment that need current when the main switches are turned off.

When pushed down, the switch is on and when pushed up it is off. The switch indicates a short circuit or interference in the electronic circuit by springing up to the “off” position. The switch can be reconnected by pushing it back down to the “on” position. Do not reconnect the switch before you have found out the reason for the interference.

The direct supply switches must be left on even if the current from other circuits is switched off. An appliance that is switched off too early may cause the appliance to overheat and become damaged.

⚠ WARNING

Turning the direct supply switch off too early may cause the device (for example, the heater) to break or catch fire, because the devices have a ventilation feature that works even if the device is otherwise switched off.

- Make sure the device is cooled down before turning it off completely. For more information, see the manual of the device in question.

4.2.5 Fuses

The fuse panel includes fuses for the boat’s equipment.

The fuses are in the form of trip switches that break the circuit and spring up when tripped. Do not reset the switch before you have found out the reason for the breaker tripping. After that press the switch back down.

⚠ WARNING

Before connecting an electric circuit, make sure that the circuit is not damaged and that there will be no short circuit or a fire caused by possible damages in the electric circuit. Any damaged equipment must be maintained or changed before they are again taken into use.

The fuse panel is located on the aft wall of the front cabin. The panel has a combined switch and fuse for macerator, fresh water pump and fridge. The fuse panel also has a 12 V output.

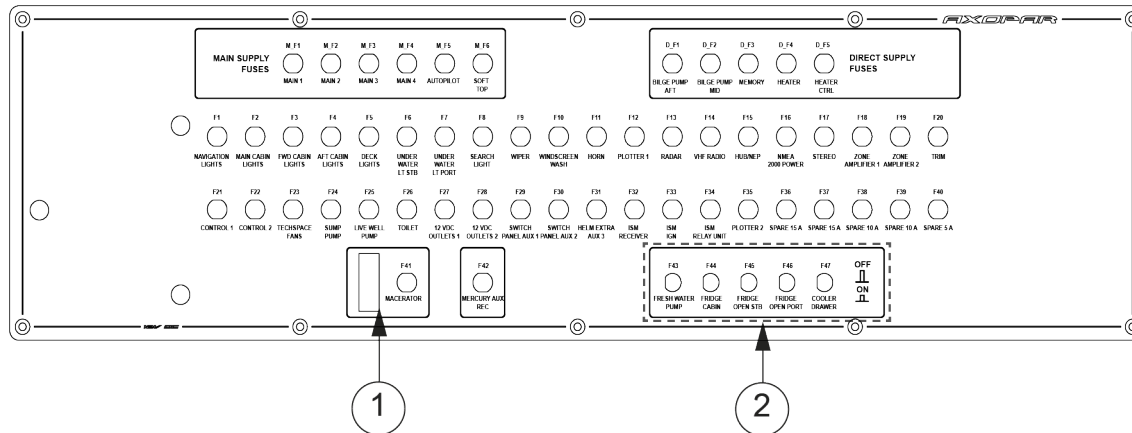

- (1) Macerator switch and fuse
- (2) Fresh water pump and fridge switch and fuse

4.2.6 Heavy duty fuses

There are fuse panels containing fuses for appliances and electronic circuits which require large currents, such as windlasses, in the boat.

The functioning of fuses can be checked from the holes in the fuse's cover. If the metal strip visible in the hole is unbroken, the fuse is operational.

If the metal strip is damaged, meaning that an overload has occurred, contact a qualified nautical electrician.

⚠ WARNING Opening the cover is not recommended, as there is a danger of electric shock and serious injury.

If the metal strip is damaged, contact a qualified nautical electrician. If it is necessary to open the cover, make sure that all the current cables from the batteries are disconnected.

4.2.7 Batteries

The batteries are located in the aft of the boat. The exact location of the batteries is presented in the section **Electrical System**.

⚠ WARNING

Only use maintenance-free AGM batteries in the boat.

- When you leave the boat, switch off the main switches unless the shore power cable is connected.
- Remove the batteries from the boat for winter storage.
 - When removing a battery, detach the negative pole first.
 - When disconnecting batteries, be careful not to touch both poles at the same time with a metal tool.

4.2.7.1 Charging the batteries

⚠ WARNING

- Make sure that the battery compartment is always well ventilated when charging batteries.
- Only charge batteries in the boat with the boat's own chargers. In other cases, remove the batteries from the boat.
- Remember that the batteries discharge an explosive oxy-hydrogen gas at a voltage of 14.4 volts.
 - The voltage of a normal battery in unloaded status is 12.3-12.7V.
 - During charging, the voltage increases and the charging regulator stops the charging process automatically at a preset level.
 - The voltage measurement must be taken at the battery terminals, not the alternator, to achieve the correct result.

4.2.7.2 Winter storage

For winter storage, the batteries can be left on board only if they are fully charged.

A partially discharged battery can freeze and crack. Always disconnect the cable terminals from the battery to avoid oxidation. When removing batteries, disconnect the negative pole first and make sure that there are no flammable or explosive materials or liquids nearby. When putting the batteries back in place, connect them in reverse order (positive pole first).

4.2.7.3 Cleaning the batteries

The top of the batteries needs to be cleaned regularly to avoid current leakage between the cells. If the battery is located in a separate area, it is normally sufficient to clean it in the spring and autumn.

Make sure that the air holes in the cell plugs are open so that gas can be vented.

The terminals and cable terminals must be lubricated to prevent deposits and corrosion.

4.2.8 110/230V system

You can choose to equip your boat with the optional 110/230V AC system with a shore power connection, which will allow you to use devices that run on the standard mains current.

The system obtains its power from an external supply on shore or from the jetty (shore power). In the European market the system used is 230V and in the American market 110V.

The system functions when a shore power cable has been connected to the shore power socket connection.

1. Turn off the shore power switch before connecting or disconnecting the cable.
2. Connect the shore power cable to the boat before connecting it to the shore power.
3. Disconnect the shore power cable from the shore power before disconnecting from the boat.
4. Close the hatch of the boat's shore power connection.

⚠ CAUTION

Unplug the shore power cable before starting the engines. Starting the engines with the shore power cable connected may break the battery isolators.

The system's main fuse is located in a separate control panel. The system includes a battery charger, which starts charging batteries automatically when the boat has been connected to shore power. The location of the components is presented in the section **Electrical System**.

The shore power system needs to be checked at least biannually. Always disconnect the shore power cable when the system is not in use. Metal casings of installed electrical equipment must always be connected to earth in the boat electrical system. Use electrical equipment equipped with earth protection only.

⚠ DANGER

Risk of electric shock and fire!

- Do not touch an energized high voltage system.
- Do not change the plug of the shore power cable. Use compatible connectors only.
- Try to minimize the risk of electric shock, short circuit and fire.
- Do not allow the shore power cable to hang in the water. If it does, a hazardous electric field could be created in the water.
- Never modify the connections on the shore power cable. Use compatible connectors only.
- If the earth fault breaker is tripped, disconnect the shore power cable immediately. In such a case contact a qualified electrician for repairs before the system is used again.

⚠ DANGER

To avoid an electric shock and risk of fire:

- Switch off the shore power switch before connecting and disconnecting the cable.
- Connect the shore power cable to the boat before connecting it ashore.
- Disconnect the shore power cable ashore before disconnecting it from the boat.
- Close the hatch to the shore power socket on the boat carefully, avoiding getting it wet.

4.2.9 Fuel system

The boat has a fixed fuel system and a water-separating fuel filter on the suction line.

Instead of the fuel system used in the European region, the boats produced for the American region use the EPA (United States Environmental Protection Agency) fuel system regarding the NMMA (National Marine Manufacturers Association) certification rules.

See the fuel system drawing in **Appendix II**. For care and maintenance of the fuel system, see the instructions in the engine manual.

⚠ WARNING

Never start the engines if there is strong gasoline odor present.

⚠ WARNING

Do not smoke or handle open flames when refueling.

Remember that it is not allowed to store fuel in spaces not specifically designed for it. Since there is no ventilated storage space on this boat, possible spare fuel cans must be stored on deck.

Fuel system component locations

- The fuel tank is located in the middle of the keel. Prevent damage to the fuel lines.
- The inlet pipe for fuel is located in the starboard side of the deck.
- If the boat has been equipped with an extra diesel tank, the inlet fitting and tank are located in the aft of the boat.
- The fuel tank valves and the fuel filter are located under the driver's seat. The EPA fuel system is equipped with an automatic fuel valve.

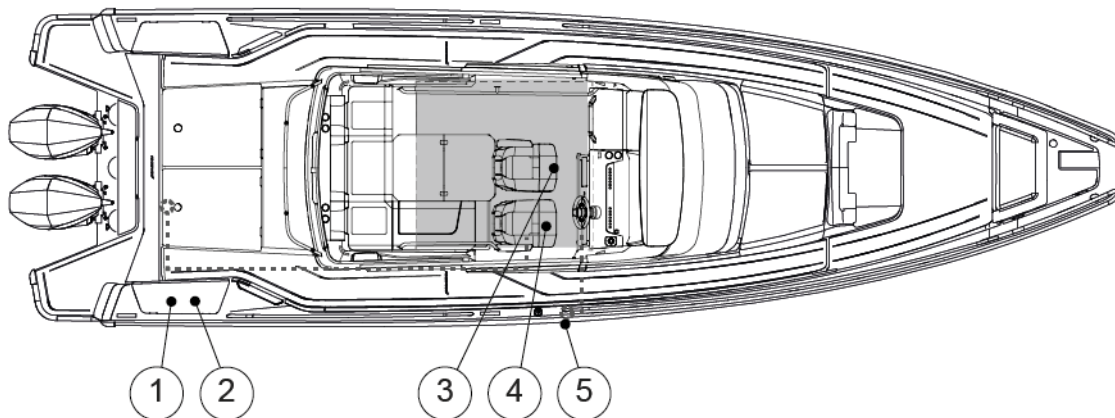

- (1) Diesel tank
- (2) Diesel tank inlet fitting (under hatch)
- (3) Fuel tank
- (4) Fuel filter
- (5) Fuel inlet fitting

4.2.9.1 Refueling the boat

If the boat has optional decking material, wet down the deck with water before refueling. This ensures that any fuel spillage will float on the water and not penetrate the decking material.

Water reaching the engine's injection system can cause rapid corrosion damage to the precision components in the injection pump components. For this reason, it is vital to check the extra fuel filter regularly for water. Every so often, drain a small quantity of fuel into a suitable container (avoid fuel spillage) and check that there is no condensation water. If there is water in the filter, continue to drain until only clean fuel appears.

The fuel system on the engine is sensitive to air bubbles in the fuel. Always fill the tanks well before they are completely empty. If the system has been run dry, it must be bled before the engine can be started again. See the engine manufacturer's instruction manual before bleeding the fuel system.

⚠ WARNING

- Never block access to safety equipment, fire extinguishers, fuel valves or main power switches.
- Never block any ventilation openings made in the boat because their purpose is to clear the air of fuel fumes.
- Never use a wrong type of fuel in the heater or cooker as this may damage them.
- Never use an open flame when detecting leaks.

4.2.9.2 Maintaining the fuel system

Follow the engine manufacturer's maintenance schedule.

- Annually, check the condition of the hoses and make sure that there are no visible cracks, abrasion, or deterioration.
- Replace worn parts with genuine, marine-grade parts only.
- Bi-annually and for winter storage, check the fuel tank compartment for possible accumulated water. This can be done by inserting a thin hose through the aluminium pipe at top of the tank. The pipe guides the hose to the lowest part of the fuel tank compartment. The compartment can then be emptied with wet-dry vacuum cleaner connected to the hose.
- Bi-monthly, inspect the fuel system for presence of water in the fuel tank.

Presence of water in fuel can be checked by inspecting the contents of the fuel filter.

If any water is found, it must be removed and the whole fuel tank dried before the tank can be refilled with fuel.

- Examine the fuel tank and lines for corrosion and leaks.

4.3 Optional equipment

This section presents the optional equipment and systems available for the boat.

4.3.1 Freshwater system

You can choose to equip your boat with an optional freshwater system.

The freshwater system consists of a fresh water tank, pump and filter. The fresh water tank is filled via the filling cap.

The freshwater system is turned on by switching on the freshwater pump. The system maintains a working pressure automatically, which is why the pump does not need to be shut after use.

- Switch off the system when the boat is left unattended.
- Check the filter regularly.

Antifreeze is added during production phase of the boat, and the dealer is responsible for disinfecting the freshwater tank before sale.

NOTICE

The water from the system is not meant for drinking.

The freshwater system must be thoroughly emptied for winter storage.

It is not recommended to use any anti-freeze products in the freshwater system.

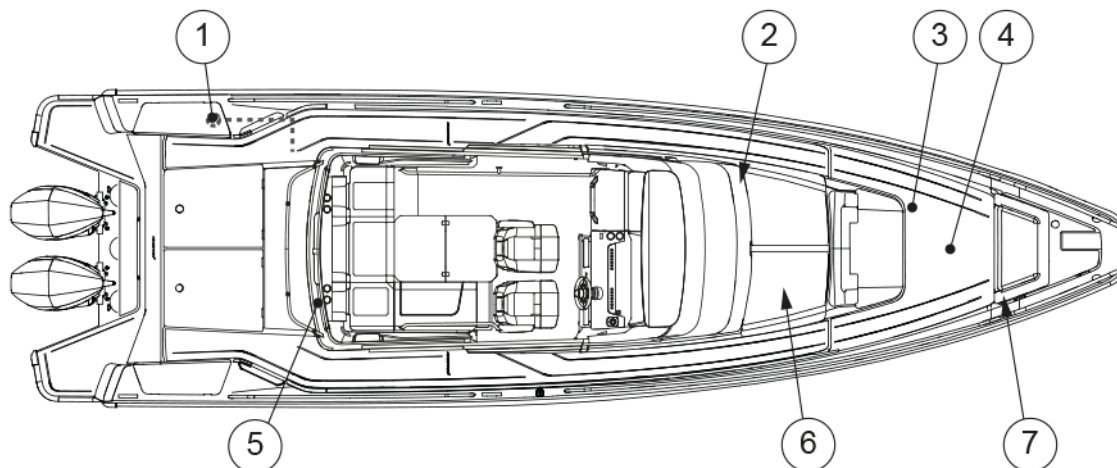

- (1) Deck shower
- (2) Pilothouse pantry tap
- (3) Freshwater pump
- (4) Freshwater tank
- (5) Wetbar tap
- (6) Switch for water system
- (7) Freshwater filling cap

The water pump has air release valve which should be slightly opened to facilitate priming when starting the pump or emptying the tank. Once the pump operates normally, the valve should be closed.

The water pump has also two LEDs indicating the operating status and faults in the pump operation. For more information about the signals, please refer to manufacturer's manual.

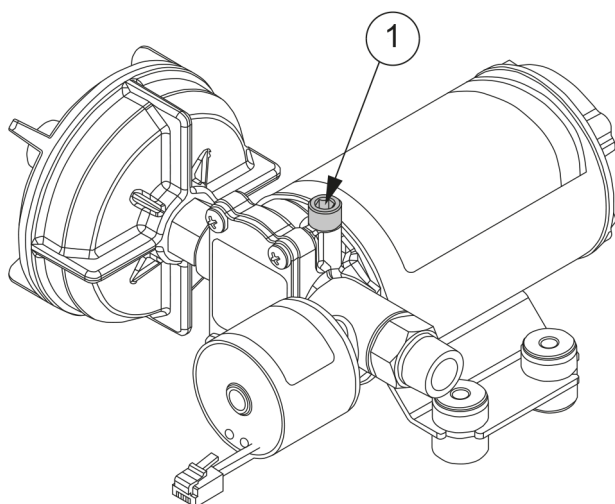

Figure 4.1 Water pump and air release valve

Freshwater system needs to be disinfected and flushed annually or after longer periods of non-use to keep the system in working order.

Disinfection procedure is described below:

1. Flush the entire system thoroughly by running potable water to flow through it.
2. Drain the system completely.
3. Fill the entire system with disinfecting solution and follow the manufacturer's instructions.
4. Drain the entire system once disinfection process is complete.
5. Flush the entire system thoroughly several more times with potable water.
6. Fill the system with potable water. Freshwater system is now ready to be used.

Maintenance

Annually inspect hose connections, tube fittings and pump electrical wiring connections for proper securing and no chafing. Water pump inlet filter is recommended to be checked and cleaned annually. Running the system regularly helps keep the water pump's impellers in working order.

4.3.2 Warmwater system

The boat can be equipped with the warmwater system as an option.

The warmwater system consists of a water boiler and associated hardware.

The water boiler is located in the bow of the boat, behind a sealed hatch in the anchor box.

- To reach the boiler, unscrew the screws in the service hatch.
- Switch on the water boiler from the switchboard located in the anchor box.
-  Switch on the freshwater pump before switching on the water boiler.
- Operating the water heater empty damages the system.
- Adjust the water temperature by rotating the thermostat dial mounted on the boiler.

WARNING

Water might reach scalding temperature if the thermostat is set to high setting (above 5).

For more information on the thermostat adjustment, see the manufacturer's manual.

Maintenance

See the manufacturer's manual for maintenance instructions for the water boiler. Inspect the boiler's hose connections regularly for signs of leaks.

4.3.3 Wet bar in port fender box

You can choose to equip your boat with an optional wet bar in fender box. The wet bar is in the boat's port side fender box.

Wet bar is equipped with a faucet, sink, and a cooled compartment. The fresh water in the wet bar is either cold or cold/warm water depending on whether warmwater system is installed or not. The cooling unit for the cooled compartment is located towards the bow from the fender box. The shut-off valve for the sink drain can be accessed via the round inspection hole at the bottom of the cooled compartment.

Maintenance

- Inspect the faucet for leaks or drips.
- Clean the sink and faucet with a mild detergent, avoiding abrasive materials that could scratch the surface.
- Drain and flush the water system to prevent any buildup of sediments or bacteria.
- Check the cooled storage box for consistent temperature and operational efficiency. Clean the interior with a soft cloth and a solution of baking soda and water to eliminate odors and stains.
- Annually ensure all connections, including water supply lines and drain pipes, are secure and free of corrosion.

4.3.4 Septic system

The boat's septic system consists of the toilet seat, the septic tank and the related systems.

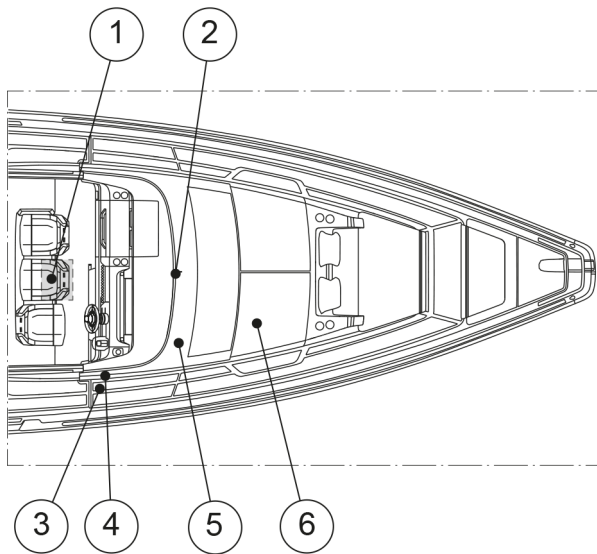

- (1) Septic tank
- (2) Shower sump pump
- (3) Deck suction fitting
- (4) Macerator pump
- (5) Toilet
- (6) Septic tank seacock

Maintaining the macerator

The macerator pump can get stuck if it is not used for extended periods of time. Regular use of the macerator helps to prevent this from happening.

If the macerator pump gets stuck, please contact your dealer for repairs.

4.3.4.1 Toilet seat

The boat is equipped with an electrical toilet seat system that uses fresh water.

NOTICE

- Never put any other objects but toilet paper in the toilet.
- In order to avoid damages, you must also not pour hotter than lukewarm water into the toilet.
- It is under no circumstances allowed to flush paper towels, fabric or rubber products, hard objects, oil products or solvents down the toilet.

Using the electrical toilet

The electrical toilet is used with a separate operating switch. For more information on the device, see the manual for the toilet.

Maintaining the toilet

- Clean the toilet with a mild cleaner.
- Never use cleaning agents or deodorants which contain pine oil, formaldehyde or chlorine, nor corrosive or petroleum-based agents.
These materials can damage the plastic and rubber parts in the toilet.
- Lubricate the pump shaft with Vaseline to increase the service life of the seal.
- Flush the toilet system thoroughly with fresh water when the boat is not in use.

4.3.4.2 Septic tank



Avoid environmental pollution!

The blackwater tank is fitted with a deck outlet pump using an international standard type connection. Using the pump, the black water can be emptied to a permanent septic tank ashore. These facilities must always be used.

In areas where there are no permanent septic tanks, the macerator is used to evacuate the contents of the tank straight into the water as follows: Open the sealed seacock. If possible, empty the tank daily and always in deep waters far from the shore. For the location of the pump, see the section **Septic system**.



The shut-off valve must be closed after the evacuation.

Do not allow the tank to become full. It can lead to paper becoming compacted in the bottom of the tank, making it more difficult to empty.

NOTICE

Before the boat is laid-up for winter storage, the whole system must be cleaned and flushed thoroughly while the boat is still in the water.

The whole system must be thoroughly drained of water when the boat is lifted out of the water.

This measure prevents frost damage, bacteria growth and smells.

Use of antifreeze is not recommended, since it is impossible to guarantee that it reaches all parts of the system.

4.3.4.3 Shower sump pump

The boat's shower floor is equipped with an automatic drainage pump.

The pump starts automatically when there is water on the shower floor. The pump drains the water from the boat's shower into the sea as the shower is below the waterline.

Regular checks

- Clear the shower sump pump regularly of any accumulated debris and hair.
- Test that the float switch is in working order.

Before winter storage

- Empty the shower sump pump of water.

4.3.5 Heating system

The boat can be equipped with a heating system as an optional equipment.

The heater unit is located behind the toilet room wall. In addition, there are a different number of heating vents available, depending on the boat's equipment.

The operation panel is located in the steering console.

The heater tank is located in the aft of the boat. The filling cap for the heater tank is located in the starboard afthatch.

WARNING

Appliances that burn fuel, consume oxygen and discharge toxic combustion products into the boat.

Good ventilation is essential when such an appliance is in use. Open ventilation holes and make sure that they are not blocked and that air flows freely through them.

- Never leave the boat unattended when the heater is in use.

NOTICE

Heater components may break if the wrong kind of fuel is used. For more information, see the manufacturer's manual.

- Do not switch off the heater's direct supply current before you have made sure that the appliance has cooled down.

4.3.6 Air conditioning

The boat can be equipped with a 230V/110V air conditioning (AC) as an optional system. Depending on the selected setup, the air conditioning allows climate control in the main cabin, the front cabin, and the aft cabin.

The optional air conditioning system consists of an air conditioning unit, a water pump, a strainer, a water intake valve and a ducting arrangement.

The air conditioning is controlled by control panel displays located in the main cabin and front cabin. When you set the desired temperature from the control panel displays, the unit automatically activates when the ambient temperature goes over or under the set value.

Before starting the unit:

- Ensure the sea water intake valve and the sea water outlet valves are open. The location of the valves is presented in the section **Openings in the hull and deck**.
- Ensure that the air conditioning circuit breaker is switched on.

NOTICE

Running the air conditioning unit when the water intake valve is shut can cause the unit to overheat and get damaged.

Maintenance

- Check and clean the air filter near the air conditioning unit monthly.
- Inspect the sea water circuit regularly for leaks.
- Inspect the electrical wiring and electrical connections annually for corrosion and firm seating.
- Coolant refills should be performed by a certified service provider.

Refer to the supplier's manual for complete operations, maintenance, and warranty instructions. In case of the air conditioning unit fails, please contact your boat dealer.

4.3.7 Navigation system

Your boat can be equipped with multifunction displays (MFD).

Depending on the boat configuration, the boat is equipped with single or multiple screens.

The multifunction display can be used to show electronic charts, plot courses, and navigate the boat. It also acts as interface for marine electronics and other digitally enabled equipment on board.

Refer to the supplier's manuals for complete user instructions and maintenance instructions of these functionalities and equipment.

4.3.7.1 VHF equipment

VHF radio allows instant communication between your boat and other boats, marinas, bridges, and maritime authorities.

The VHF radio is the recommended means of communication on the coastal waters, and it transmits messages on high frequency waves. The VHF system consists of a VHF radio unit near the drivers position and a radio antenna located either on the mast or on the roof of the boat depending on the boat model.



Study the provided booklet for the local regulations and the functionalities related to the use of the VHF system.



For your safety, make sure the VHF system is operational before going out to open sea.

4.3.8 Bow thruster

The bow thruster enhances the maneuverability of the bow when docking or performing other maneuvers that require increased operator control.

The bow thruster is located under the front deck inside the front cabin.

The bow thruster is powered by the Aux battery. The main switch is located in the seatbase.

The control switch is located in the steering console.

The batteries must be disconnected from the electronic circuit before changing a fuse. For more information, see the manufacturer's manual.

⚠ WARNING

Incorrect use may cause overheating and short circuiting, and pose a fire risk.

- Use the bow thruster for only short periods at a time.
- Do not exceed four duty cycles (max. 30 seconds long in 25 mins).

If overloading occurs, contact a qualified marine electrician.

⚠ WARNING

- Do not touch the bow thruster or its fuse if the Aux main switch is switched on.

⚠ DANGER

Pinching hazard

Never put your hand or any other body part near a windlass or bow roller in operation.

4.3.9 Anchor windlass

The boat can be equipped with a bow, and in some cases aft, anchor windlass (optional equipment).

Operation

To operate the windlass, windlass breaker must be switched on.

Windlass is operated with a momentary switch. Pushing the up button will raise the anchor and pushing the down button will lower the anchor.

If there is a loss of power to the windlass, check the windlass breaker to see if it needs to be reset. If the breaker keeps tripping after it has been reset, the anchor windlass system is recommended to be inspected by a qualified electrician.

The anchor windlasses are powered by the Aux battery. The battery and its fuse are located in the bow of the boat.

⚠ WARNING

- Do not touch the anchor windlass or its fuse if the main switch Aux is switched on.
- Even if the current is switched off, do not change the windlass fuse. The high current may cause a fatal electric shock.

Manual operation

In case of loss of power, the windlass can be manually operated by disengaging the clutch. Please refer to the manufacturer's manual how to operate the windlass manually.

Before using the anchor windlass

Always check that:

- The windlass is in working order.
- The anchor chain can move freely.
- The anchor and the chain cannot damage the boat when lowered.
- The anchor and anchor chain cannot hit any person.

For more information, see the manufacturer's manual.

While under way

The anchor windlass must be fixed mechanically to prevent it from coming loose when the boat is moving. For more information, see the manufacturer's manual.

⚠ DANGER

⚠ WARNING

Pinching hazard

Never put your hand or any other body part near a windlass or bow roller in operation.

⚠ WARNING

If the windlass loosens when the boat is moving at great speed, it may cause great damage to the boat, its passengers and outsiders.

- Always fix the anchor windlass mechanically in place before getting under way.

⚠ WARNING

- Keep all body parts and clothing away from an activated windlass.

NOTICE

- Do not use the windlass to pull or tow another vessel.

Maintenance

Salt deposit accumulating on the windlass should be washed away with fresh water regularly to prevent corrosion. For more information, please refer to the manufacturer's manual.

4.3.10 LPG system

The boat can be equipped with an LPG system for a cooker as an optional extra. The system is tested and approved before delivery.

The system consists of a cooker and gas cylinder. The apparatus is equipped with a shut-off valve (in connection with the cooker) and a decompression valve. A ventilation hole is provided on the outside of the hull in the space where the gas cylinder is installed. A fire blanket must be installed right next to the cooker.

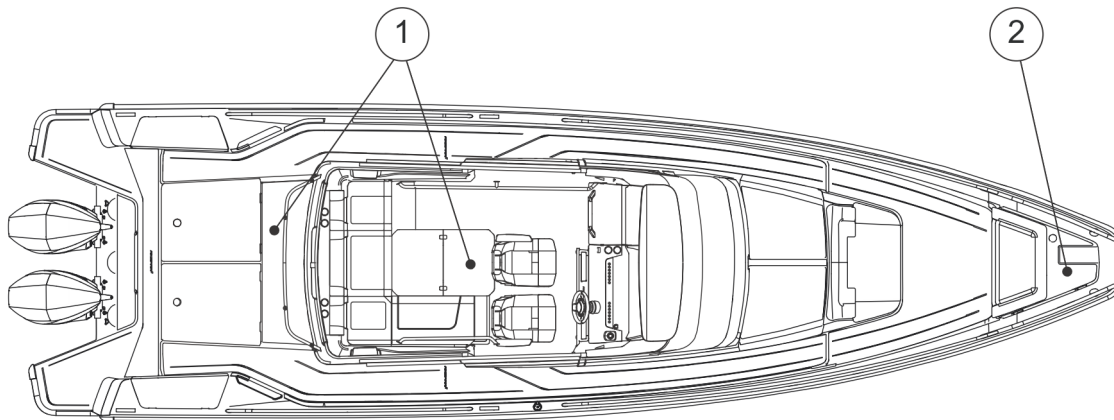

- (1) Cooker
 (2) Gas cylinder

Fuels that produce a naked flame consume oxygen and discharge combustion products into the boat. Good ventilation is therefore essential when an appliance is in use. The cabin door must be kept open when the cooker is in use.

⚠ WARNING

Fuel-burning open flame appliances consume cabin oxygen and discharge combustion products into the boat.

Ventilation is required when appliances are in use.

Open designated vent openings as indicated when appliances are in use.

- Before opening the valve to the gas container, make sure that the appliance valves are properly closed.
- Store the fire blanket in the required location.

⚠ WARNING

- Never use an open flame when detecting leaks.
- Never use the cooker or oven for heating the boat.
- Never leave the boat unattended when LPG appliances are in use.
- Never smoke or use open flames when a gas container is being replaced.
- Never block access to safety equipment, fire extinguishers, fuel valves or main power switches.
- Never block any ventilation openings made in the boat because their purpose is to clear the air of fuel fumes.

The boat owner shall keep information about the locations and types of the ventilation openings in every space where a gas appliance is installed.

NOTICE

Never use a wrong type of fuel in the cooker as this may damage the cooker.

4.3.10.1 Lighting the LPG cooker

1. Open both shut-off valves.

Each burner has an ignition cut-out which cuts the gas supply when the flame is out.

2. Press in the knob for the required burner and turn to max. position while holding the lighter beside the burner.
3. Keep the knob pressed in for about 20 seconds after the burner lights. If it is released sooner, the burner may go out.

The reason for the burner going out is that the ignition cut-out might not be hot enough.

If the burner does not light, it may be because a valve is closed, the knob is incorrectly set or the gas container is empty.

4.3.10.2 Using the LPG cooker

⚠ WARNING

- Do not use solutions that contain ammonia.
- Keep the LPG container in a space designed for it.
- Do not use areas intended for LPG containers for storing other equipment.
- Never leave the boat unattended when LPG appliances are in use.
- Do not smoke or use open flames when a container is being replaced.



- Make sure that you always have free and rapid access to the LPG system.
- The ambient temperature for LPG systems is $-20 - +60^{\circ}\text{C}$.

Ventilation

Appliances which burn fuel consume oxygen and discharge combustion products into the boat. Good ventilation is essential when an appliance is in use.

- Never use the LPG cooker for heating the boat.
- Never cover the ventilation openings.

Valves

- Close the valves on the supply pipes and the container valve when the appliance is not in use.
- Close the valves before refuelling and immediately in an emergency.
- Check that the appliance valves are closed before opening the container valve.
- Keep the valves of empty cylinders closed and disconnected.
- Fit the protective covers, caps or plugs.
- Store spare or empty cylinders on the open deck or in drained areas designed for the purpose.



Replace the regulating valve every 10 years.

The valve contains a thin rubber diaphragm which eventually dries out or swells up. If the diaphragm breaks, gas can escape from the cylinder with full pressure into the system, thus causing a fire.

Inspections

- Regularly test the LPG system for leaks by brushing with soapy water or a detergent solution which does not contain ammonia.
- Check all the connections for leakages.
 - If a leakage is detected, close the container valve and repair the system before using it again.
 - Repairs must be carried out by a qualified gas fitter.
- Inspect the hoses and pipes in the system regularly, at least once a year.
 - Replace parts if there is any deterioration or damage.
- Replace the LPG hoses outside the cabin every second year, and the LPG hoses inside the cabin every 3 to 5 years.
- Check the flue ducts at least once a year.
 - Replace the flue ducts if there is any deterioration or damage.
- Check the connection gaskets for the regulating valve always when containers are replaced, and replace the connection gaskets annually.

Maintenance

For the LPG cooker maintenance schedule and instructions, see the manufacturer's manual.

4.3.11 Solar panel trickle charger

The boat can be equipped with solar panel trickle charging system. The system allows you to maintain and slowly charge the batteries on the boat.

The solar panel is located on the bow end of the roof. The trickle charging system includes a charge controller, preventing battery overcharge. The charge controller is installed in the battery compartment wall.

Maintenance

Ensure that the solar panel is mounted properly. Check for any dirt, debris, and corrosion on the panel. Periodically clean the solar panel with water.



Do not use chemicals, as they can damage the panel.

4.3.12 Lithium power bank

The boat can be equipped with optional lithium power bank. The power bank is integrated with the boat's electrical circuit, providing electrical power for AC devices when shore power is unavailable, such as

when you are out on the sea. The system includes lithium battery bank, inverters, battery chargers, and battery management system (BMS) in one package.

The lithium power bank is in the centerline deck recess of the boat. The power bank manual main switch is located next to the power bank, and remote battery switch is located next to the remote switch panel.

The power bank is charged by the engines, optional solar power trickle charger, and shore power.

Maintenance

To maintain the power bank's efficiency, regularly check connections for corrosion or wear. Never open the lithium power batteries. Ensure the area around the power bank is well-ventilated to dissipate heat effectively. For long term storage, please see the manufacturer's manual for storage temperature and charge level.

Operation

Operating the power bank is straightforward. Switch on the power bank manual and remote main switches to switch on the power bank and to activate the inverter, which will convert the stored DC power into AC for your appliances. Monitor the BMS for real-time battery status and to manage power consumption effectively. The power bank is equipped with a transfer switch, which allows the current to by-pass the power bank when the boat is connected to shore power.

⚠ WARNING

Do not store wet items on top of the power bank.

⚠ WARNING

Do not attempt to charge or use a damaged battery.

4.3.13 Inverter and battery monitor

The boat can be equipped with optional sine wave 12V 3kW inverter. Inverter provides power and allows the use of small AC equipment whilst out of reach from shore power. The inverter comes with its own display, please see the manufacturer's manual for the functionality.

Inverter is located in the port side under the deck behind access hatch.

Battery monitor brings the battery charge level information to your multifunction display via the NMEA 2000 network.



Although the inverter can provide high surge power up to two times the rated output power, high surge loads may still trigger the inverter protection system.

4.3.14 Fender box baitwell

You can choose to convert the starboard side fender box into a bait livewell. Baitwell keeps the bait fish alive by circulating sea water in the well. The baitwell gets its raw water through the baitwell pump from the sea chest located under the deck in the aft. The baitwell has a drain to prevent the baitwell from overflowing.

Running the baitwell

To run the water in baitwell, the water intake valve must be open.

Intake valve and baitwell pump switch are located under a hatch in the stern of the boat, near the battery compartment. Baitwell pump switch is located next to the starboard fender box.

1. Open intake valve through the hatch.
2. Turn the pump on. The switch is located next to starboard fender box. The pump will start filling up the baitwell until water starts to run out from the overflow pipe
3. Leave the pump running for continuous exchange of water
4. Close the seacock when the baitwell is not in use

Maintenance

Inspect and clean the overflow drain and pump strainer from gunk after each use.

1. Clean the inside of the baitwell with distilled vinegar and hydrogen peroxide.
2. Circulate freshwater through the system a few times to rinse it.



Avoid using harsh cleaners, as they can cause the bait fish to die.

4.3.15 Roof racks

The boat can be equipped with roof racks.

Roof racks allow for transportation of bulkier objects such as kayaks or bicycles. Objects put on the roof racks must be secured tight to prevent them from falling off or damaging the boat's roof or other components.



Load limit of roof racks is 25 kg / 55 lbs per roof half. Max. load of roof racks is 40 kg / 88 lbs.

4.3.16 Searchlight

The boat can be equipped with an optional searchlight. The searchlight can be mounted on the light mast or directly on the roof depending on the boat model. The searchlight is remote-controlled and rotates 360 degrees, allowing you to illuminate objects in any direction.

The searchlight has one-touch auto sweep and S.O.S.



The searchlight has a 30-minute shut-down timer. If the searchlight is left unattended for more than 30 minutes, the searchlight turns itself off.

4.3.17 Gas grill

You may choose to equip your boat with an external gas grill. The gas grill option comes with rail mounts, storage bag, and a gas grill. Combining this option with the wet bar in fender box option allows you to create a cooking area in the aft of the boat.

The gas grill can be mounted on the side rails and requires an LPG canister. The gas canister storage is in the bow anchor locker. Wet bar gas grill and external gas grill introduce a ventilated storage canister under the anchor hatch.

For grill specific usage instructions, please refer to the manufacturer manual.

Maintenance

Cleaning the grill and its internal components thoroughly after each outing is recommended. Clean the grill with soap and water, rinse with fresh water, and dry to prevent crevice corrosion. Avoid using stainless steel polishes on grill exterior as most leave residue that may discolor when grill is heated.



The gas bottle must be stored in a ventilated area.

⚠ WARNING

The gas grill is only allowed to be used when the boat is stationary and must be stowed away before using the boat.



Use the grill outdoors only. Do not use the grill inside the boat.



Do not use the grill under sunshades or any other cover.

⚠ WARNING

Never leave hot grill unattended.

⚠ DANGER

Carbon monoxide hazard. The grill can produce carbon monoxide. Never use the grill in an enclosed space, such as when using canopy, or inside the cabin of the boat.

4.3.18 Sunshades

The boat can be equipped with canvas sunshades to provide shade in the aft and bow of the boat.



The sunshades are only for stationary use and must be stowed away before the boat is driven.

Depending on the boat model, the sunshade poles are stored in spring clips on top of the roof or inside a hatch.

Setting up a sunshade

1. String the loops of the sunshade to the ends of the support poles.
2. Mount the support poles on the gunwale sockets.

3. Connect the canvas clasps to the D-rings on the roof.
4. Adjust the tightness of the sunshade so that it's tight.

5 Transportation

5.1 Lifting the boat

Lift the boat only with a lifting beam and lifting straps. Use the specified locations for the lifting straps.



Commission only a reputable lifting company or a boat yard with sufficient lifting capacity to lift the boat. Make sure the company has full insurance cover, in case of any damages.

⚠ DANGER

Risk of serious injury or death by falling load.

- Do not stay under the boat when it is hanging in the crane.

Lift straps may slip on the hull. When appropriate, tie the straps together before lifting.

The position of the straps may need to be adjusted depending on how the boat is loaded.

In addition to the boat's own weight, take into account the equipment and other possible loads in the boat.

⚠ CAUTION

Note the location of the log transducer to avoid damaging it.

- Protect the hull sides well to avoid damages.

The lifting beam must be exactly the same width as the boat. Always take great precautions near and around the boat when lifting.

⚠ CAUTION

Risk of damage to the hull.

Do not lift the boat with a forklift.

The location of the lift straps is indicated in the figure.

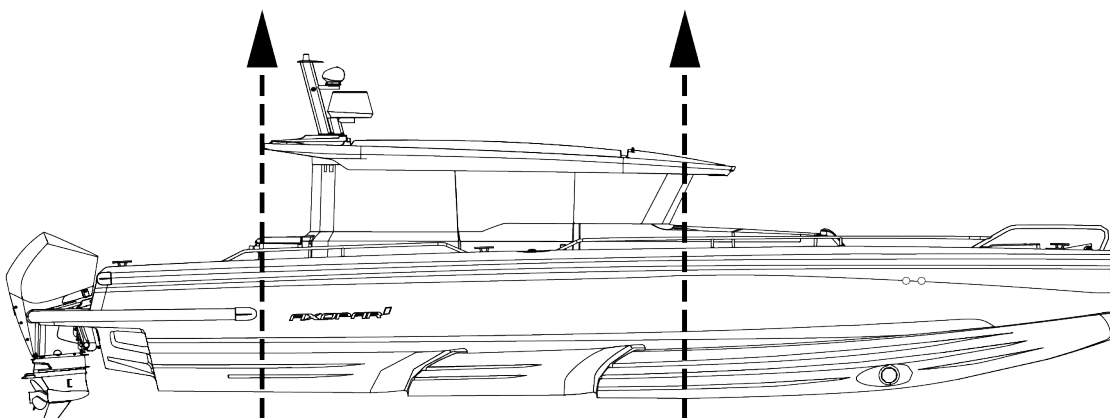

Before operating any lifting equipment:

- Check and determine applicability of federal, state, or local requirements.
- Follow the lift equipment manufacturer's requirements and recommendations.
- Check the boat's lift points, weight and other information.
- Straddle lift operation is a highly technical area that requires trained and experienced operators.

During lifting:

- Check the boat for bilge water before lifting.
Excessive quantities of bilge water can shift, changing the balance of the load.
- Check for thru-hull appendages such as knot meters and stabilizers, rub, spray, and splash rails, so that they are not damaged by the lifting equipment.
- Check the hull structure to locate shafts, rudders, struts, and the forward and aft ends of any keels.
- Check the hull's structural configuration, including the location of bulkheads, stringers, engines, and tanks.
- Check bilges for water ingress following launch.
- Transport the boat as close to the ground as practicable.

5.2 Transporting and storing the boat

Before lifting the boat onto the trailer, make sure that the trailer is suitable for the boat.

Make sure that there is a sufficient number of supports to distribute the weight properly without excessive point loads, and the capacity and dimensions of the trailer are sufficient to carry the boat and its engines, equipment, battery, boating accessories and fuel on board. Pay special attention to exposed areas and edges of hull, such as strakes and steps in the hull, during loading, deloading and transportation.

WARNING

A boat trailer that does not have sufficient capacity or that is poorly maintained can become damaged and cause a danger on the road.

- Make sure that the trailer capacity is sufficient to also carry the weight of the engines, fuel and equipment.

CAUTION

The hull of the boat can be damaged if there is an insufficient amount of supports on the trailer or during the storage.

The trailer must be a little nose heavy. Make sure that the boat is securely fastened to the trailer, that it cannot move into any direction, and that the side supports provide an even support for the weight of the boat.

Before loading the boat on the trailer:

- Remove any unnecessary weight from the boat.
- Drain the bilge water.
- Adjust the side supports of the trailer so that the most weight rests on the keel supports, and the side supports only offer lateral support.

- Protect the boat by placing suitable padding between the tie down straps and the boat, if necessary.
- See the engines manual for any instructions on trailering.
- Make sure that the doors and hatches are properly closed.
- Pay attention to any equipment and accessories in the boat during trailering.
 - Make sure you secure all loose items in the boat.
 - Do not use a hood, canopy, tonneau cover or other similar top or cover on the boat during trailering.

These hoods and covers can become detached at high speeds and damage the boat and cause a danger to traffic.

A hood or other cover flapping in the wind during trailering can damage the boat surface.

- Keep the hood in its dedicated storage compartment during trailering, or remove the hood completely, if necessary.

6 Operation

The boat owner must take local and international regulations into consideration concerning the boat crew, equipment and handling of the boat. In some countries, a driving license or a separate authorization is required for driving the boat. Special regulations may also apply.

Ensure that the anticipated wind and wave conditions do not exceed the design category of the boat, and that the crew is able to handle the boat in these conditions. Even though the boat is designed for such conditions, they can still be very dangerous. Only a capable, fit and trained crew, using a well maintained boat, can satisfactorily operate in such conditions.

If the boat is fitted with a life raft, carefully read its operation manual. Onboard, the boat must have the appropriate safety equipment according to the boat type and weather conditions. This equipment is compulsory in some countries. The crew must be familiar with the use of all safety equipment and the most important actions in different emergency situations. Sailing schools and clubs regularly organize rescue drills.

The equipment in the boat may differ from the equipment used in the figures in this manual. This might be due to any optional equipment chosen or modifications made after producing this manual. In such cases, contact your local dealer for the operation instructions and additional information regarding the operation of the equipment in question.

Always maintain the boat properly and make allowance for the deterioration that occurs over time and as a result of heavy use or misuse of the boat. Any boat, no matter how strong it may be, can be severely damaged if not used properly. Inappropriate use of this boat not compatible with safe boating is not allowed. It is always important to adjust the handling of the boat to the sea conditions and own boating experience. The gelcoat parts, especially the colored parts, need to be polished and waxed approximately every fourth months to prevent the parts from fading or getting other visual defects.

6.1 Handling devices

6.1.1 Steering console

The controllers are situated so that the driver can easily manage them from the steering console.

The location and quantity of the devices depend on what optional equipment and engine models have been chosen. See the device manuals for further information on the devices.

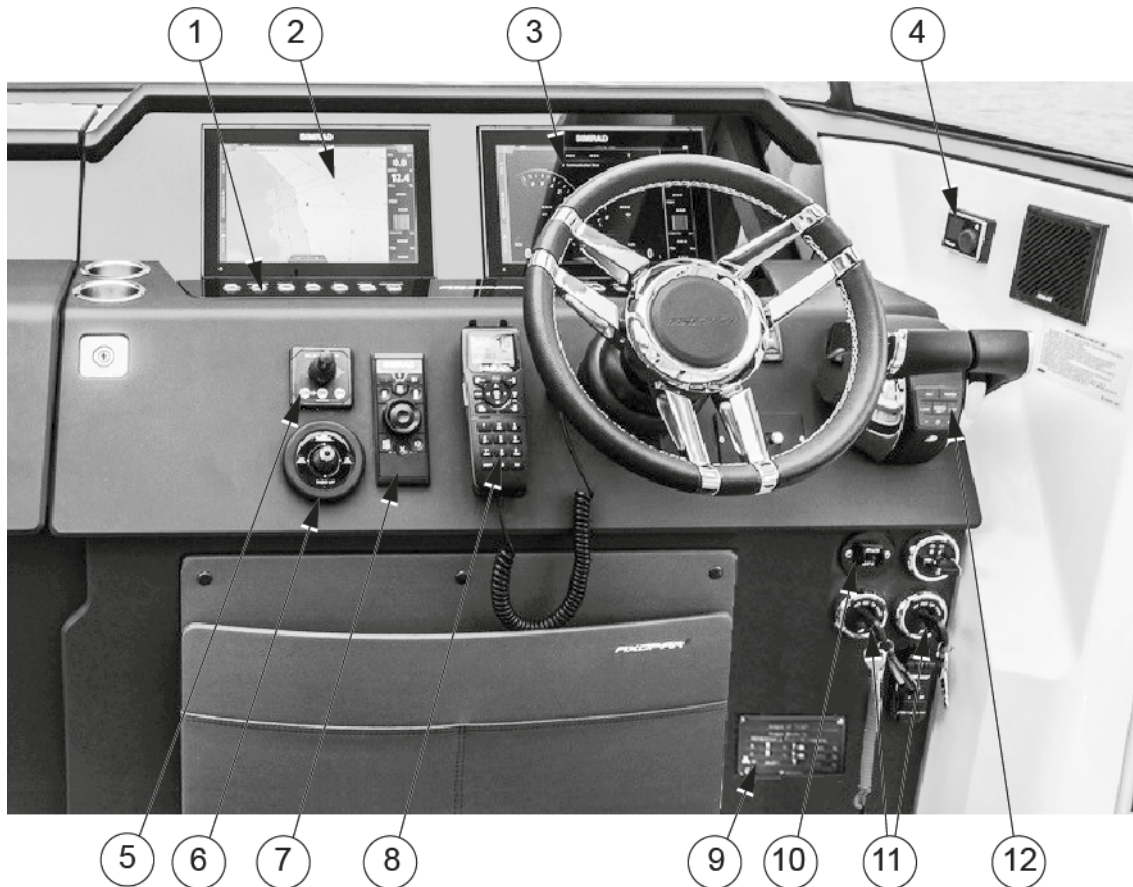

- (1) Steering console switch panel
- (2) Chart plotter
- (3) Chart plotter
- (4) Heater control unit
- (5) Bow thruster control panel
- (6) Trim tabs control unit
- (7) Chart plotter remote unit
- (8) VHF
- (9) Builder's plate
- (10) Emergency stop
- (11) Ignition keys
- (12) Engine remote control

6.1.2 Windscreen wipers

The boat's windscreen wipers are controlled by the switches in the boat's steering console. A switch for the windscreen washer is installed next to the switch for the windscreen wipers. The windscreen wash-fluid tank is located beside the fresh water tank.

6.1.3 Steering system

The steering system is one of the most vital systems related to safe boating.

The boats are equipped with a hydraulic steering system with the alternatives of power steering and non-power steering systems. Please refer to the collateral manuals provided by the outboard engine and steering system manufacturer included in the manual package provided with the boat.

The non-power steering system consists of a steering wheel, a helm pump, a hydraulic hosing, and a hydraulic steering cylinder.

The power steering system includes a steering pump to help with the handling of the vessel.

6.1.3.1 Checking and topping up oil

Effective and properly working steering is crucial for the safety of the boat.

- Check the oil level in the pump before casting off.
- For detailed instructions and the steering system oil recommendation, see the manufacturer's documentation.

6.1.3.2 Steering maintenance

For the regular maintenance of the steering system components, please refer to supplier's manual.

If you encounter issues beyond regular maintenance needs, please contact your boat dealer immediately for service.

6.1.3.3 Steering console switch panel

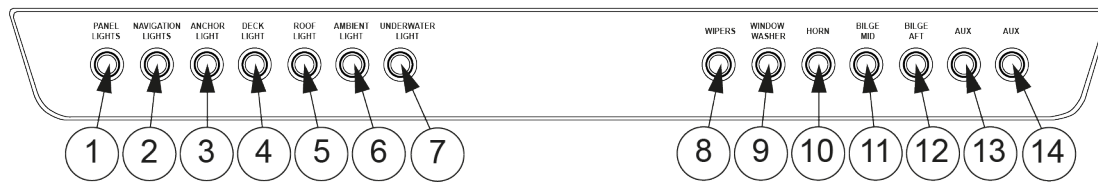

- (1) Panel lights
- (2) Navigation lights
- (3) Anchor lights
- (4) Deck lights
- (5) Roof lights
- (6) Ambient light
- (7) Underwater light
- (8) Wipers
- (9) Window washer
- (10) Horn
- (11) Bilge mid
- (12) Bilge aft
- (13) Aux
- (14) Aux

6.1.4 Starting the engine

See the engine manufacturer's manual for engine information.

1. Set the engine lever in neutral.
2. Turn the ignition on and check the fuel level.
3. Start the engine by turning the ignition key.
4. Check that the gauges for oil pressure and volt meter show normal values.
5. Run the engine to operating temperature at idling speed. Never rev up a cold engine.

⚠ DANGER

Risk of carbon monoxide poisoning.

Be aware of the risks with engine exhausts. For example, under turbulence or disadvantageous wind conditions, exhaust can enter the boat. If this happens, avoid idling the engines. If these problems occur under way, do not open the hatches and ventilators, as it can worsen the problems. Instead, you may try solving the problems by changing the boat's speed or weight distribution.

⚠ WARNING

Never step onto the swim ladder when the engine is running. Stop the engine while the steering and propeller are being inspected.

⚠ WARNING

Do not operate this boat with an engine that exceeds the maximum engine power recommended by the manufacturer.

6.1.5 Throttle lever

The engine throttle and shift are controlled by the electronic throttle lever. To start the engine, the lever must be in the neutral position. The throttle lever is used to control the engine's RPM which affects the speed of the boat.

Moving the lever forward shifts engine into the forward gear, and moving the lever backwards shifts the engine into the reverse gear. Progressively moving the lever in one direction will increase the speed of the boat in that same direction.

For detailed guidelines about safe boating and component maintenance, please refer to the provided outboard engine literature. If you encounter issues beyond regular maintenance needs, or if noticeable failures occur, please contact your boat dealer immediately for service.

⚠ WARNING

Always make sure no one is close to the propeller when starting the engine or engaging the propeller! Acknowledge the information provided on the helm's warning labels.

6.1.5.1 Trim and tilt

The engine can be raised or lowered with the trim controls in the throttle lever.

Raising and lowering the engine is needed when trailering or launching the boat. Adjusting the trim angle of the engine also allows optimizing the run angle for the boat to achieve optimal performance or fuel efficiency.

When raising the engine(s) all the way, make sure the engines are facing straight aft, and no optional equipment such as foldable seats or aft deck gates are in the way.

Refer to the supplier's manuals for detailed operation instructions, maintenance, and warranty information.

⚠ WARNING

Raising the engines out of the water without paying attention to surrounding equipment such as aft deck gates, foldable seats or waterski frame may cause damage to the engines.

6.2 Swivel seat - Driver and passenger seats

The driver and passenger seats are operated with locking handles.

⚠ DANGER

The locking handles must be in the locked position before the boat speed exceed 5 knots.

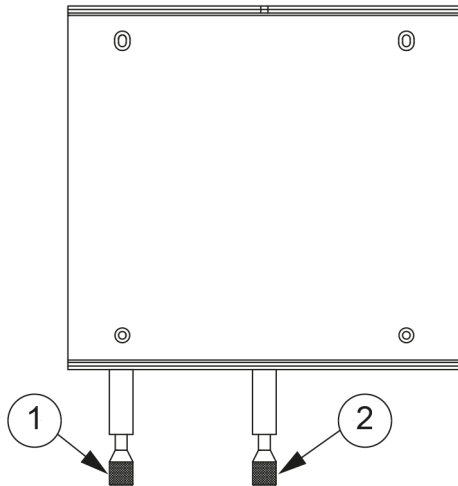

- (1) Rotation locking handle
- (2) Moving locking handle

- For the rotating function, press the locking handle down to release the lock. This allows you to rotate the seat on the post.
- For the moving function, lift the locking handle up to release the lock. This allows you to move seat from back to front.

6.3 Inspecting the boat

Due to safety reasons, the below listed inspections must be carried out before and after using the boat.

6.3.1 Checklist: Regular inspection before leaving harbor

Safety

Make sure that:

- All the people onboard have life jackets.
- The wind and wave conditions do not exceed the design category of the boat.
- The dead man's switch is switched to driver.
- There is a fire extinguisher (or several) onboard and their approval/inspection date has not expired.
- The needed ropes and anchor are onboard.

Draining and tightness

Check that:

- There is no water in the bilge.
- All the bilge pumps are functional.
- The bilge has no signs of fuel or oil leaks.

- The deck drain system is clean and the valves are open.
- All deck hatches are tightly closed.

Electrical and engine

Check that:

- All the fuses are intact.
- The main switches are switched on.
- The batteries have enough power.
- The engine works properly.
- The engine cooling water flows as expected.
- The fuel level is sufficient.

⚠ WARNING

The specified tank capacity is not necessarily fully available, depending on the trim and load on board. The tank must always be kept at least 20% full.

6.3.2 Checklist: After using the boat

Make sure that:

- The main switches are switched off.
- The septic tank discharge valve is closed.
- There is no water in the bilge.
- The bilge pumps are functional.
- The deck draining works properly and all the draining valves are open.
- All deck hatches, roof canvas and doors are tightly closed.

6.4 Handling the boat

6.4.1 Checklist: Boat handling before leaving harbor

For safe navigation under all weather conditions, proper sound signaling equipment in compliance with regulations (COLREG, 1972) must be carried on board. Make sure that the sound signaling equipment on the boat is compliant with these regulations.

⚠ CAUTION

According to national regulations in some countries, it is a legal requirement to wear a life vest at all times.

- Check that the boat and its equipment are in seaworthy condition.
- Always listen to long-term weather forecasts when planning longer trips.
- Always make sure there is enough fuel and freshwater in the tanks.
- Check that all items on board are properly stowed and adequately secured to manage rough sea and wind conditions.
- Make sure that the swim ladder is raised out of the water before moving off.
- Make sure that the steering is correctly positioned before starting.
- All persons on board must wear an appropriate life vest when on deck.

6.4.2 Leaving the jetty

Before casting off, consider how to best leave the jetty.

- Check what the wind direction is.
- Using a bow thruster, move the bow out and then engage the propeller.
- If the boat has two engines, move away from the jetty by engaging the engine nearer the jetty astern at idling speed and engaging the other engine ahead at idling speed on.
- The boat will swing out from the jetty astern. As the bow will move against the jetty, fend off properly.

With only one engine this can be a little more challenging, especially if the wind is pressing the boat firmly against the jetty, you have to use a spring to get the stern out.

- Firmly fend off the bow from the jetty.
- Take a line from the bow around a bollard or cleat, so that it can be easily let go.
- Engage idling speed ahead and turn the rudder so that the stern glides out from the jetty.
- When the boat has reached a position, where it can safely be reversed, release and retrieve the line, quickly center the rudder and engage astern.

⚠ CAUTION

Gather in all lines and fenders while you are still in sheltered water. A rope around the propeller can disable a boat.

6.4.3 Driving the boat

Going out in a motor boat involves responsibility not just to those on board, but also to others we meet on the water. Showing consideration for others makes boating comfortable. Everyone has the same right to be at sea, whatever kind of boat they go afloat in.

The physical laws that apply to a boat are rather different from, for example, those affecting a car, as are the possibilities of controlling it.

You can influence a boat's behavior and the level of comfort on board primarily by adapting the speed to the prevailing sea conditions and by the intelligent use of the trim tabs. A planing boat rides almost level

in the water at maximum speed. As the speed of the boat is reduced the trim angle increases and the bow rises slightly. This is normal, and is a prerequisite for good performance.

6.4.3.1 Dead man's switch

If the boat is equipped with a dead man's switch, attach its lanyard to yourself immediately after detaching the mooring lines. For more detailed instructions, see the engine manual.

It is very important that the boat stops if you for some reason fall overboard or stumble on board, particularly if you are alone. However, remember to detach the lanyard from your wrist before docking or beaching operations to prevent the engine from stopping unintentionally.

6.4.3.2 Driving at high speed

Although the boats have passed the CE requirements for swerve tests at full speed, Axopar Boats does not recommend making sharp turns at high speed. When exceeding a certain speed limit any hull construction might lose its grip. This might lead to passengers hurtling out of the boat, especially in a single engine configuration.

- Do not use the boat if it has an engine with a higher power rating than indicated on the capacity plate.
- Do not drive the boat at high speed if the engine's rig angle is negative (bow down).
- Do not drive at full speed on congested waterways or if the visibility is limited because of weather conditions or waves.
- Reduce your speed and wake as a matter of courtesy, and also for the safety of yourself and others.
- Observe and obey speed limits and prohibitions associated with a swell.
- Follow the rules of navigation and the requirements of COLREG (Convention on the International Regulations for Preventing Collisions at Sea).
- Always make sure that you have the space needed for avoiding collisions and coming to a halt and for evasive maneuvers.
- Always use a dead man's switch if available.
- Reduce speed in high seas for increased comfort and safety.
- Learn the boat's speed potential. Utilize this knowledge for economical and safe cruising.
- Avoid using high speed along with large rudder movements when going astern, because that places great strain on the rudder and steering mechanism.
- Avoid sudden steering maneuvers at high speeds.
- Avoid staying in the bow area when driving at high speeds.

Avoid sudden changes in travel direction at high speed. Let the boat come to a stop, and the engine rev down before shifting between forward and reverse. Otherwise excessive strain is put on the engine, which could cause the engine to stop. In the worst case, sea water may enter the engine.

A right-handed propeller rotates clockwise and a left-handed propeller anti-clockwise, seen from the stern. The rotation of the propeller is critical for steering the boat. The right-handed propeller pushes the stern of the boat to starboard when the engine is engaged ahead and to port when it is going astern. The direction of rotation of the propeller has a major impact on the turning radius. A right-handed propeller gives a smaller turning radius to port than to starboard. This is called the propeller's paddlewheel effect.

The boat's propellers have considerable propulsion power that provides powerful acceleration. Take this into consideration to avoid dangerous situations arising from this.

⚠ DANGER

A revolving propeller is life-threatening to a swimmer or a person who has fallen overboard.

Use the dead man's switch and turn off the engine when someone is climbing on board.

6.4.3.3 Driving in rough seas

Never go out in rough seas, if you are uncertain whether the boat and those on board can cope. Follow these simple rules.

- Be well prepared.
- Remember to secure loose equipment.
- Always have a sea anchor and other emergency equipment easily accessible.
- Avoid breaking seas that can appear close to land and over shallows.
- If there are significant waves, always reduce speed to guarantee the safety of the persons on board.
- Use the trim tab to trim the bow down to reduce hull slamming in a head sea.

In a head sea

- Adjust speed to suit the size of the waves.
- Adjust the trim angle to the size of the waves. Avoid taking seas beam on.

In a following sea

Remember to keep the bow high in a following sea. Avoid crashing through waves, maintain low speed. If necessary, deploy the sea anchor to reduce speed.

Planing boats can be particularly exposed in rough following seas. The stern of the boat rises and the rudder does not answer, so the boat broaches while the bow cuts down into the sea.

6.4.3.4 Maneuvering in narrow channels

When maneuvering the boat in narrow channels, the engine speed must be kept as low as possible so that maneuvers are calm and steady.

In difficult wind and current conditions, more revs might be necessary to make full use of the power of the engine. In these conditions, it is important that maneuvers are made quickly and precisely to prevent the boat from drifting into trouble for example.

A good rule before starting a maneuver under difficult conditions, is to think through the different situations which could arise. Pay attention to the wind and current conditions and decide in advance which maneuver you will make. It is also important to brief crew members on what they need to do in different situations.

Always keep in mind that the stability of the boat may be reduced when towing.

⚠ CAUTION

Even a nonslip molding can be slippery to walk on when the deck is wet.

6.4.4 Visibility from steering position

The International Regulations for Preventing Collisions at Sea (COLREG) demand that a proper lookout is kept at all times, and the *right of way* rule is followed.

The following factors can considerably reduce visibility, among other things:

- Gear trim angle
- Trim tab angle
- Load and load position
- Speed
- Rapid acceleration
- Changeover from displacement speed to planing
- Sea conditions
- Rain and thunderstorms
- Darkness and fog
- Inner lighting when under way in the dark
- Position of curtains
- People and equipment that block the driver's view.

⚠ WARNING

Make only small adjustments at a time. Holding down the button for the trim tab for any length of time can result in partial loss of control of the boat.

6.4.5 Using the trim tabs

A boat does not need trim tabs to get up on the plane or to give good performance. However, trim tabs are a very useful aid when used correctly.

There are two situations in particular where the trim tabs need to be used:

- When it is desirable to trim the bow down in a rising sea and at speeds between going up planing and cruising speed.
- When running with a strong beam wind.

A planing boat always leans into a strong side wind. This reduces the boat's seakeeping qualities, which is why listing to one side needs to be eliminated as far as possible. Lowering the trim tab on the windward side brings the boat back into normal attitude.

For trimming the bow down, both trim tabs are used in parallel. Begin by retracting both trim tabs completely, then lower both of them a little at a time, so that you retain complete control over how the boat is affected. When running with a following sea, both trim tabs always need to be fully raised. The reason for this is that boats have a tendency to "dive" in a strong following sea, which can result in uncontrollable slowing. Therefore you must run the boat with a high bow angle in a following sea.

6.5 Preventing falling overboard

The boat's working decks are areas where people can move about when the boat is being maneuvered. The working deck area is shown in grey in the figure.

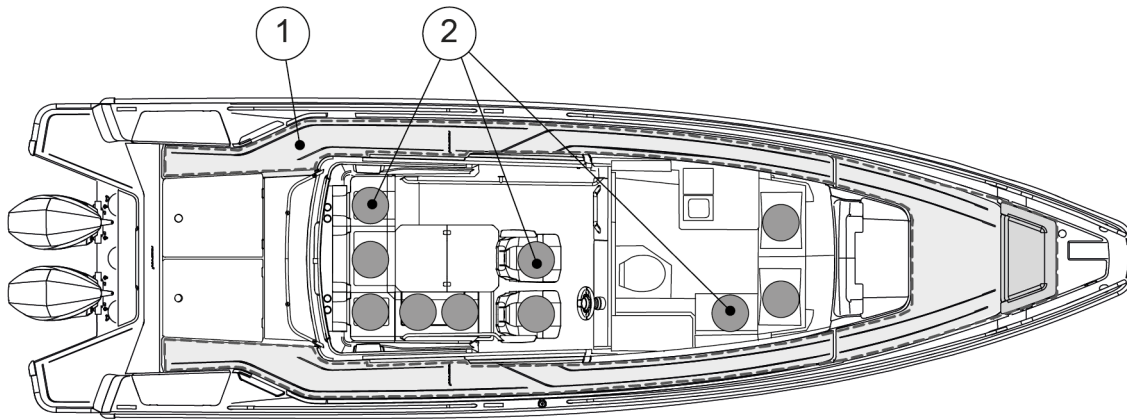

- (1) Working deck area
- (2) Seats

Do not sit, stand or spend time in other parts of the boat while the boat is under way.

Moving about in the aft part of the aft deck and on the front deck while the boat is under way is not recommended.

If the boat is equipped with aft deck gates, keep them closed while under way.

If a person has fallen into the water, the easiest way to get back on board is to use the swim ladder. The ladder can be pulled down also from the water.

Staying on deck

⚠ WARNING

Staying in the bow of the boat is not recommended in speeds exceeding 30 knots.

⚠ DANGER

A revolving propeller is life-threatening to a swimmer or a person who has fallen overboard.

- Use the dead man's switch.
- Turn off the engine when someone is climbing on board.



If the sun deck cushions or the front deck table are in place, observe the maximum speed of 15 knots to avoid the cushions or table detaching at speed or in high waves.

6.6 Anchoring, docking and mooring

6.6.1 Fastening points

Fastening points (or cleats) are located both at the stern, midship and bow.

- When anchoring or towing, the forward force is 37,6 kN.
- When mooring the forward force is 30,7 kN.
- When mooring the rearward force is 26,2 kN.

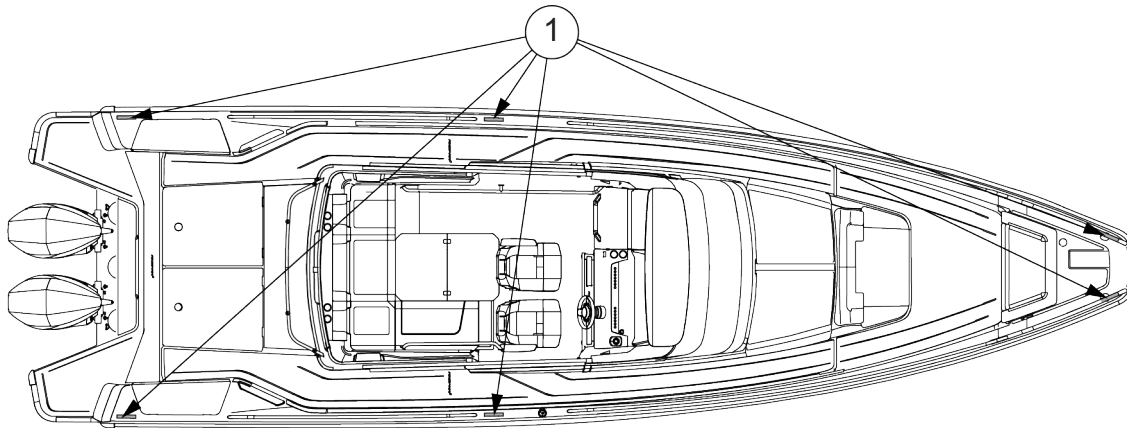

(1) Fastening points

⚠ CAUTION

The breaking strength of lines shall in general not exceed 80% of the breaking strength of the fastening points.

6.6.2 Docking

Always brief your crew how you are planning to dock. Fenders and at least one mooring line fore and aft must be in place before approaching the jetty.

It is always easiest to dock against the wind. Try to hold the bow exactly into the wind and maintain sufficient speed for the boat to answer the rudder. If the bow is blown off in one direction, back out and repeat the maneuver. Bring the bow up to the jetty, and make sure you get a line ashore quickly.

Docking with a side wind is a little more difficult. Do not steer parallel to the jetty letting the boat blow in as there is always a risk of the bow being blown off towards other boats or the jetty. Instead, try to maneuver the boat so that the wind comes directly from astern. Then the boat can be maneuvered straight ahead since the wind helps hold the boat on a straight course. It is good to have someone on the foredeck that can go ashore and quickly turn the bow in the desired direction after the boat has stopped completely.

Try to always avoid sharp movements of the throttle, since idling speed in ahead and astern is generally adequate. Sharp movements of the throttle can lead to panic maneuvers.

⚠ CAUTION

The tensile strength of the lines or chains should normally not exceed the strength of the fastening point in question.

6.6.3 Checklist: Before anchoring

1. Check the chart to see if anchoring is permitted in the area.
2. Listen to the weather forecast for the area and take note of the expected wind conditions.
3. Switch on the echo sounder.
4. Study the seabed conditions and make sure that there is good holding ground.
5. Check that the safety chain has been released from the anchor.
6. Wait until you have reached the intended anchoring point before lowering the anchor.
7. Let out the anchor line equal to at least three times the depth of the water.
8. Put the engine in astern to check that the anchor has taken hold (only when bow anchoring).
9. Note your position on the GPS. Regularly check that the boat has not moved from its position.
10. Set the echo sounder to "Anchor Watch".

⚠ WARNING

Always fix the anchor in such a way that it is securely fastened onto the boat. An anchor that falls off when under way may cause serious damage to the boat and mortal danger to the crew.

6.6.4 Towing and mooring

⚠ CAUTION

When towing another boat or being towed, always drive slowly. If the boat you are towing is of the displacement hull type, never exceed its hull speed.

- Always attach the tow line so that it can be detached under load. It is the owner's and users' responsibility to ensure that the mooring lines, towing lines, anchor chains, anchor lines and anchors are adequate for the vessel's intended use.
- Always remember that the stability of the boat may decrease when being towed.

7 Maintenance

7.1 Cleaning and maintaining the gelcoat surface

The gelcoat surface of the boat is subjected to environmental conditions which can, under certain circumstances, lead to deterioration of the surface. Overtime, these external factors such as saltwater, high UV exposure and temperature variation, can have an effect on the gelcoat surface.

Generally, gelcoat should last 3 years without showing any significant signs of yellowing, chalking, or other deterioration in typical conditions.

NOTICE

Clean and maintain regularly all the gelcoat surfaces on the boat.

If the regular cleaning and maintenance is neglected, or if the boat is exposed to certain environmental conditions where it is berthed, deterioration of the surface finish such as fading, discoloration and brittles may become visible over time.

- Wash and clean the boat after every trip, and weekly if it is stored outside uncovered.
- Wax the boat twice a year if used all year, otherwise annually.
- Inspect the gelcoat surface annually for signs of deterioration, such as brittle surfaces or changed color tones.
- Small scratches or discolorations can be fixed by buffing or polishing.
- Severe scratches, discoloration or oxidation may require wet sanding before buffing, polishing and waxing.

Wet sanding is recommended to be performed by an Axopar dealer or a trained professional.

- When the boat is not in use, keep the gelcoat surface out of the sun or cover the boat with a canvas tarpaulin.

Do not use plastic or other non-porous materials, which can trap moisture between the cover and the surface.

Washing

NOTICE

Use a cleaning product specially made for boats. Do not use household cleaning products, chlorine, acids or similar as they may damage the boat surface due to their improper pH value.

Wash the boat after every trip by using a mild cleaning product. Dilute the cleaning product with fresh water according to the instructions on the product label.

1. Rinse the deck and hull with fresh water to remove loose dirt.
2. Wash the surfaces with the diluted cleaning product and a soft-bristled brush.
3. Rinse off with fresh water.

Waxing

Waxing the gelcoat surface restores gloss and protects the finish. Only use wax recommended for gelcoat, and follow the product instructions carefully.

Wax can either be applied by hand using a clean rag, or with an orbital-motion buffing machine.

NOTICE

If using a buffing machine, do not exceed the speed of 1200 rpm. Using a higher speed may burn the gelcoat.

NOTICE

Do not wax a gelcoat surface in direct sunlight.

1. Apply wax and wait for a few minutes until the wax looks dry.
2. Buff the wax either by hand using a clean rag, or by using a buffing machine.
Buff in circular motions until the surface is clean and glossy.
3. Finish by wiping the potential wax residues off with a clean rag.

Polishing and buffing

Small scratches or discolorations can be fixed by polishing and buffing the boat. If the surface has severe discoloration or oxidation, wet sanding is recommended before polishing and buffing.

- Polishing compounds remove small scratches and discolorations.
- Buffing compounds contain abrasive and remove deeper scratches or oxidation.
Buffing compounds can be used, for example, to remove scratches on the hull caused by the fenders.
- After using the buffing compound, use polishing compound to achieve the best possible finish.
- Follow the product instructions of the compound carefully.

Polishing and buffing compounds can either be applied by hand using a clean rag, or with an orbital-motion buffing machine with a polishing pad.

NOTICE

When using a buffing machine, do not exceed the speed of 1200 rpm. Using a higher speed may burn the gelcoat.

NOTICE

Do not polish or buff a gelcoat surface in direct sunlight.

1. Apply polishing or buffing compound on the surface and wait for a few minutes until the compound looks dry.
2. Polish or buff the compound either by hand using a clean rag, or by using a buffing machine with a polishing pad.
Buff in circular motions until the surface is glossy.
3. Wax the surface.

Wet sanding

NOTICE

Wet sanding is recommended to be performed by an Axopar dealer or a trained professional.

Severe scratches, discoloration or oxidation of the gelcoat surface may require wet sanding. Wet sanding can be done either by hand or by using a machine.

NOTICE

When using a machine, do not exceed the speed of 1200 rpm.
Using a higher speed may burn the gelcoat.

NOTICE

Do not wet sand a gelcoat surface in direct sunlight.

1. Spray water to the area that needs to be sanded.

NOTICE

Keep the surface continuously moist while sanding.

2. Sand the surface with a 1000 grit sandpaper (for example Mirka Abralon).
If you use a machine, use a low rpm speed to get the best result.
Keep sanding until the entire surface is equally matt.
3. Sand the surface with a finer 1400 grit sandpaper.
4. Sand the surface once more with an even finer-grit sandpaper.
This saves time in the buffing and polishing stage.
5. After sanding, when the surface looks equally matt, rinse the surface with fresh water and allow to dry.
6. Buff and polish the surface to get the gloss back.
7. Wax the surface.

7.2 Antifouling

Painting your boat's hull with antifouling paint is worth considering if your boat is most of the season in water.

Boats that are frequently lifted out of the water and relaunched during the boating season can be affected by antifouling oxidization. Out-of-the water, antifouling paint will oxidize, which will prevent the biocide release and slowly cause antifouling to lose its effectiveness. Follow the paint manufacturer's specifications for launching window.

Antifouling wears gradually over time, depending on factors such as the location where the boat is used and how often the boat is used. As a rule of thumb, antifouling lasts one season once applied. When the antifouling needs to be repainted, it is important to use the same antifouling paint as the existing antifoul, or to scrub off old antifouling paint down to gel coat. If different antifouling paints are used, there is a risk that the composition of the paints are incompatible, preventing the antifouling paint from working.

Contact your nearest Axopar dealer in antifouling repainting and condition inspection related matters.

7.3 Maintaining the interiors

7.3.1 Wooden interiors

The interior details of the boat, such as the locker doors and drawer fronts and wooden strips, are made of oiled wood.

- Clean the wooden interior details with a damp cloth and a small amount of soapy water.
- Treat the wooden surfaces again every year to protect the wood.

7.3.2 Plastic and painted surfaces

1. Wet the surface evenly with water before the actual cleaning.
2. Remove stains.
 - Remove regular stains with a brush and a lightly diluted cleaner.
 - Remove grease with a brush or a sponge and window cleaner.
3. Clean the surface afterwards with sponge and water.
4. Wipe dry with a piece of cloth.

7.3.3 Fabrics

The interior fabrics are washed according to separate washing instructions (marking on the fabric).

In case the marking is not visible:

1. Wash in 40°C with a light spin cycle.
2. Hang to drip dry.

The material may slightly shrink. If you want to avoid shrinking, take the fabrics to a dry cleaner.

7.3.4 Doors and hatches

- Clean the tracks of sliding doors and hatches regularly and lubricate, if necessary.
- Lubricate handles and locks with regular lock lubricant.

7.4 Maintaining the cover



New covers may leak initially, as the seams need to swell.

During use

To prevent quick deterioration of the cover, secure it tightly in a folded-up position to prevent flapping.

After use**NOTICE**

- Hang to dry. Never use a drying cabinet or iron to speed up drying.
- Check that the cover is completely dry before stowing. Stowing a moist cover can cause mold damage.
- Store the cover in dry indoor conditions for the winter.
- The cover must not be stored in the boat.

7.4.1 Cleaning the cover

The cover needs to be thoroughly cleaned two or three times a year.

NOTICE

Never use high pressure washers or chemical cleaning agents.

1. Let the fabric cover soak for at least 24 hours.
2. After soaking, wash the inside and outside of the cover with a sponge or a soft brush.
Use mild soapy water and plenty of water, max. 30°C.
3. Rinse thoroughly with freshwater.
Mix 12% vinegar in the final rinsing water to neutralize the soap residues.
4. Hang the cover to drip dry.

7.5 Protecting underwater metal parts

Boat's underwater metal components, such as thru-hulls, seacocks, trim tabs, engine internal components and propellers, are subject to electrolytic corrosion. Electrolysis and galvanic corrosion (corrosion of dissimilar metals in salt water) can occur in marine environment due to external factors such as stray currents, polluted waters, or proximity of other vessels. It is important for boat owner to be aware of the phenomena, as they can cause serious deterioration over time.

Signs of electrolytic corrosion are, for example, white, powdery substance on exposed metal such as propellers or breakers, or thru-hulls and seacocks turning greenish. If the corrosion has progressed far, even deep pitting can appear on the part's surface.

The boats are equipped with sacrificial anodes to protect the metal parts from galvanic corrosion. Additionally, boats equipped with shore power have galvanic isolators to stop low voltage currents from flowing through the boat.

All underwater metal parts need to be inspected annually for signs of corrosion. Additionally, underwater thru-hulls and seacocks are recommended to be replaced every 5 years. Please refer to chapter **Preventing corrosion** for more details.

7.6 Preventing corrosion

Sacrificial anodes are installed on the boat's trim tabs and engines to protect metallic parts from corrosion damage. The anodes need to be replaced regularly as they wear out to protect other metallic parts.

- Inspect the anodes monthly.
- Replace them when approximately fifty percent of the anode has deteriorated.

In general, anodes need replacement once a year in fresh water, and more frequently in saltwater environment. If there is an increase in the consumption speed, it can be a sign of electrical issue and the root cause should be investigated.

7.7 Preventing frost damage

- The bilge pump system is fitted with a water lock on the hose.
 - Detach the hose and fully drain the water from the water lock and run the pumps dry. Otherwise the pumps may freeze and break.
- Unscrew the frost plug on the underside of the shower fittings.
 - If there is no frost plug, unscrew the shower hose.
- Drain the water tank and all other components containing water in order to avoid frost damage.
- Run the freshwater pump dry to drain out all the water.
- Make sure that no water remains in the boat under any circumstances. Leave the hatches in the cabin partially open.

7.8 Checklist: Before winter lay-up

- Wash the hull and bottom immediately after lifting the vessel out of the water.
- Wash all parts inside, also under the floorboards.
- Leave all lockers, drawers, and cabin and wardrobe doors open.
- Remove the carpets.
 - Store the carpets and cushions indoors in a dry place.
 - If this is not possible, make sure that the cushions are dry and position them on their side.
- Disconnect and service the air conditioner.
 - Switch off the power and disconnect the power supply.
 - Close the seacocks.
 - Drain the cooling water circuits and pumps, or fill them with antifreeze.
 - Check the more detailed instruction in the manufacturer's manual.
- Disconnect and service the fridge.
 - Switch off the power and disconnect the power supply.
 - Defrost the fridge.
 - Clean and dry the exterior and the interior of the fridge.

- Empty and dry the condensate water tray.
- Leave the door slightly ajar to enable ventilation.
- Check the more detailed instruction in the manufacturer's manual.
- Ensure good ventilation in the boat.

NOTICE

If the batteries are left aboard, make sure they are fully charged, otherwise the batteries can freeze and crack.

7.9 Checklist: Before launching

1. Remove the tarpaulin in good time before launching.
2. Wash the hull with a regular shampoo and a soft brush.
3. Wax the hull, if necessary.
Use a standard boat wax.
4. If there are small scratches on the hull or if some of the surface gelcoat has lost its shine, use a rubbing compound on these areas before polishing.
5. Paint the bottom with antifouling paint.
6. If the batteries have been removed, put them back and check the electrolyte level in the cells.
Check the condition of the batteries.
7. Check all cables, clamps, engine mountings and other fastenings.
8. Check the steering before launching.
9. Check the instrumentation.
10. Close all water drain plugs.
11. Check that the seacocks are tight and in order, check for any frost damage.
12. Check all pipes, hoses and cocks.
13. Make a note of any frost damage.

7.10 Corrective maintenance

7.10.1 Deposits

Mild detergents and fine rubbing compounds reduce the weathering and calcium deposits accumulated on the surfaces.

NOTICE

Do not apply the rubbing compound in direct sunlight.

- Use only a fine grit compound, and follow the label instructions carefully.
- For the best result, wax the surface after treating it with the rubbing compound.

7.10.2 Scratches and nicks

Most scratches and nicks can be removed by using a rubbing compound followed by waxing.

7.10.3 Stains

Most stains can be removed by washing with a mild detergent.

- For stubborn stains, use a fine abrasive household cleanser followed by waxing to restore original luster.
- For non-water-soluble stains, such as grease, oil, and rubber heel marks, use a solvent such as acetone, rubbing alcohol, toluene or xylene, followed by a mild detergent.
 - If these solvents are not effective, try a rubbing compound or fine sanding followed by waxing.

7.10.4 Deep marks, gouges and holes

Deep marks, gouges and holes should be repaired professionally.

Gelcoats can be well repaired by professionals, and in most cases the repair will be undetectable.

NOTICE

In cases where the damage has pierced the gelcoat layer, further exposure to water or chemicals should be avoided.

Failure to observe this precaution may result in extensive and potentially costly damage to the underlying laminate structure.

8 Environment

When handling environmentally hazardous substances such as fuel, oils, solvents, grease, bottom coats, you need to consider the following:

- Always read the instructions for each product carefully and handle the product with care.
 - Make sure that the used packaging, cans and similar items are discarded in designated collection points.
 - If you are in any doubt whether the product is hazardous or not, contact the supplier or vendor of the product.
- The backwash from boats wears down the shoreline and creates problems for other boats near you.
 - Always adjust your speed to the situation and the surroundings to avoid unnecessary backwash.
- Always drive the boat at the most economical engine revs possible, taking the prevailing conditions into account, to avoid unnecessary emissions and noise.
- Make sure that the engine is properly serviced at regular intervals so that noise and emission levels are minimized.
 - Read the engine manufacturer's manual carefully.
- As a boat owner you must be aware of the local environmental laws, and respect codes of good practice.
 - Never empty the septic or blackwater tank into water.
 - Familiarize yourself with the international regulations on the prevention of marine pollution (MARPOL) and comply with these regulations.
- Always investigate the source of any oil leaks as soon as possible.
- Dispose of recovered spilt oil correctly.
- Keep oil-absorbing cloths or rolls on board.
- Never dispose of overboard any oil, paint or other chemical that is potentially harmful to the environment. Sanctions are in place in most parts of the world for those who disregard this rule!

⚠ WARNING

Any oil must be treated as chemical waste.

8.1 Requirements for North America

The EPA standards state that in freshwater lakes, freshwater reservoirs or other freshwater impoundments whose inlets or outlets are such as to prevent the ingress or egress by vessel traffic subject to this regulation, or in rivers not capable of navigation by interstate vessel traffic subject to this regulation, marine sanitation devices certified by the U.S. Coast Guard installed on all vessels shall be designed and operated to prevent the overboard discharge of sewage, treated or untreated, or of any waste derived from sewage.

The EPA standards further state that this shall not be construed to prohibit the carriage of Coast Guard-certified flow-through treatment devices which have been secured so as to prevent such discharges. They also state that waters where a Coast Guard-certified marine sanitation device permitting discharge is allowed include coastal waters and estuaries, the Great Lakes and interconnected waterways,

freshwater lakes and impoundments accessible through locks, and other flowing waters that are navigable interstate by vessels subject to this regulation (40 CFR 140.3).

9 Appendix I: Checklists

9.1 Checklist: Fire in the engine

- Stop the engine.
- Steer the boat up against the wind, if possible.
- Make sure all passengers have life jackets.
- If necessary:
 - Evacuate the passengers.
 - Call for sea rescue.
- Shut off fuel, LPG and main power switches.
- Extinguish the fire.
- Wait until fully certain that the fire has been extinguished before opening the engine cover.
Carefully open the engine cover and be prepared to use the handheld fire extinguisher if necessary for post-fire extinguishing.
- Put out possible smoldering fires with water.

9.2 Checklist: After fire

- Open doors and windows for better ventilation.
- Inspect the boat and its equipment, and repair any damages.
- Contact local authorities, if needed.
- Make sure that the fire extinguishing equipment is refilled or replaced after use.

9.3 Checklist: After grounding

If the boat hits a rock, the damage may be easily visible or hidden.

- Make sure that everyone on board is wearing a life jacket.
- Check that everyone on board is up on the deck.
- If necessary, make an emergency call or use a distress signaling device.
- Immediately after a capsize, check the bilge for leaks. Even if the bilge pump is not rated for leaks, you may try to empty the boat using it.
- Stop the engines and lift them out of the water.
- Turn off all the main electrical switches.
- If you can detach the boat after a rock slide, check the condition of the engine.
- Inspect the boat for leaks.
- To avoid further damage to the engine, do not drive the boat if, for example, you notice an oil leak or the engine blade is damaged.

- If the leak is small, the boat is detached and at least one of the engines is functioning, drive to the nearest shore to prevent the boat from sinking.
- If a life raft is available and required, prepare it for use.
- If you detect a leak, close all doors and hatches. Open doors and hatches may cause the boat to drown more quickly.
- Do not go inside of the boat if it has a leak.
- Call for towing assistance from local authorities or other agencies.
- A professional should inspect the boat after grounding. Even if there is no visible leak, the hull may be damaged and in need of repair.

⚠ WARNING

A big leak may cause the boat to sink quickly. Do not go or stay in and wear a life jacket.

9.4 Checklist: Regular inspection before leaving harbor

Safety

Make sure that:

- All the people onboard have life jackets.
- The wind and wave conditions do not exceed the design category of the boat.
- The dead man's switch is switched to driver.
- There is a fire extinguisher (or several) onboard and their approval/inspection date has not expired.
- The needed ropes and anchor are onboard.

Draining and tightness

Check that:

- There is no water in the bilge.
- All the bilge pumps are functional.
- The bilge has no signs of fuel or oil leaks.
- The deck drain system is clean and the valves are open.
- All deck hatches are tightly closed.

Electrical and engine

Check that:

- All the fuses are intact.
- The main switches are switched on.
- The batteries have enough power.
- The engine works properly.
- The engine cooling water flows as expected.
- The fuel level is sufficient.

⚠ WARNING

The specified tank capacity is not necessarily fully available, depending on the trim and load on board. The tank must always be kept at least 20% full.

9.5 Checklist: After using the boat

Make sure that:

- The main switches are switched off.
- The septic tank discharge valve is closed.
- There is no water in the bilge.
- The bilge pumps are functional.
- The deck draining works properly and all the draining valves are open.
- All deck hatches, roof canvas and doors are tightly closed.

9.6 Checklist: Boat handling before leaving harbor

For safe navigation under all weather conditions, proper sound signaling equipment in compliance with regulations (COLREG, 1972) must be carried on board. Make sure that the sound signaling equipment on the boat is compliant with these regulations.

⚠ CAUTION

According to national regulations in some countries, it is a legal requirement to wear a life vest at all times.

- Check that the boat and its equipment are in seaworthy condition.
- Always listen to long-term weather forecasts when planning longer trips.
- Always make sure there is enough fuel and freshwater in the tanks.
- Check that all items on board are properly stowed and adequately secured to manage rough sea and wind conditions.
- Make sure that the swim ladder is raised out of the water before moving off.
- Make sure that the steering is correctly positioned before starting.
- All persons on board must wear an appropriate life vest when on deck.

9.7 Checklist: Before anchoring

1. Check the chart to see if anchoring is permitted in the area.
2. Listen to the weather forecast for the area and take note of the expected wind conditions.
3. Switch on the echo sounder.
4. Study the seabed conditions and make sure that there is good holding ground.
5. Check that the safety chain has been released from the anchor.
6. Wait until you have reached the intended anchoring point before lowering the anchor.
7. Let out the anchor line equal to at least three times the depth of the water.

8. Put the engine in astern to check that the anchor has taken hold (only when bow anchoring).
9. Note your position on the GPS. Regularly check that the boat has not moved from its position.
10. Set the echo sounder to "Anchor Watch".

⚠ WARNING

Always fix the anchor in such a way that it is securely fastened onto the boat. An anchor that falls off when under way may cause serious damage to the boat and mortal danger to the crew.

9.8 Checklist: Before winter lay-up

- Wash the hull and bottom immediately after lifting the vessel out of the water.
- Wash all parts inside, also under the floorboards.
- Leave all lockers, drawers, and cabin and wardrobe doors open.
- Remove the carpets.
 - Store the carpets and cushions indoors in a dry place.
 - If this is not possible, make sure that the cushions are dry and position them on their side.
- Disconnect and service the air conditioner.
 - Switch off the power and disconnect the power supply.
 - Close the seacocks.
 - Drain the cooling water circuits and pumps, or fill them with antifreeze.
 - Check the more detailed instruction in the manufacturer's manual.
- Disconnect and service the fridge.
 - Switch off the power and disconnect the power supply.
 - Defrost the fridge.
 - Clean and dry the exterior and the interior of the fridge.
 - Empty and dry the condensate water tray.
 - Leave the door slightly ajar to enable ventilation.
 - Check the more detailed instruction in the manufacturer's manual.
- Ensure good ventilation in the boat.

NOTICE

If the batteries are left aboard, make sure they are fully charged, otherwise the batteries can freeze and crack.

9.9 Checklist: Before launching

1. Remove the tarpaulin in good time before launching.
2. Wash the hull with a regular shampoo and a soft brush.
3. Wax the hull, if necessary.
Use a standard boat wax.

4. If there are small scratches on the hull or if some of the surface gelcoat has lost its shine, use a rubbing compound on these areas before polishing.
5. Paint the bottom with antifouling paint.
6. If the batteries have been removed, put them back and check the electrolyte level in the cells.
Check the condition of the batteries.
7. Check all cables, clamps, engine mountings and other fastenings.
8. Check the steering before launching.
9. Check the instrumentation.
10. Close all water drain plugs.
11. Check that the seacocks are tight and in order, check for any frost damage.
12. Check all pipes, hoses and cocks.
13. Make a note of any frost damage.

10 Appendix II: Fuel system

FIND NO	CODE	PART LIST	LENGHT [m]	QTY
1	AX81692	FUEL TANK		1
2	AX80817	FUEL INLET		1
3	AX81635	CARBON CANISTER		1
4	AX81636	P-TRAP		1
5	AX81720	TEE-ALU		1
6	AX81632	ONE DIRECTION VALVE FI 38		1
7	AX81633	ONE DIRECTION VALVE FI 16		1
8	AX70575	CLAMP 35X50		4
9	AX70576	CLAMP 16X27		10
10	AX70440	FUEL HOSE DN38 - FUEL INLET	4,8	1
11	AX70439	FUEL HOSE DN16 - MAIN VENT	4,7	1
12	AX70439	FUEL HOSE DN16 - TEE	0,1	11
13	AX70439	FUEL HOSE DN16 - CARBON CANISTER	1,9	1
14	AX70439	FUEL HOSE DN16 - P-TRAP	0,1	1
15	AX70605	FUEL HOSE DN12 - FUEL POWER	11,6	1
16	AX70180	VENT HOSE - AFT - FI75MM		1
17	AX70180	VENT HOSE - BOW - FI75MM		1
18	AX70577	CLAMP 12X22		2

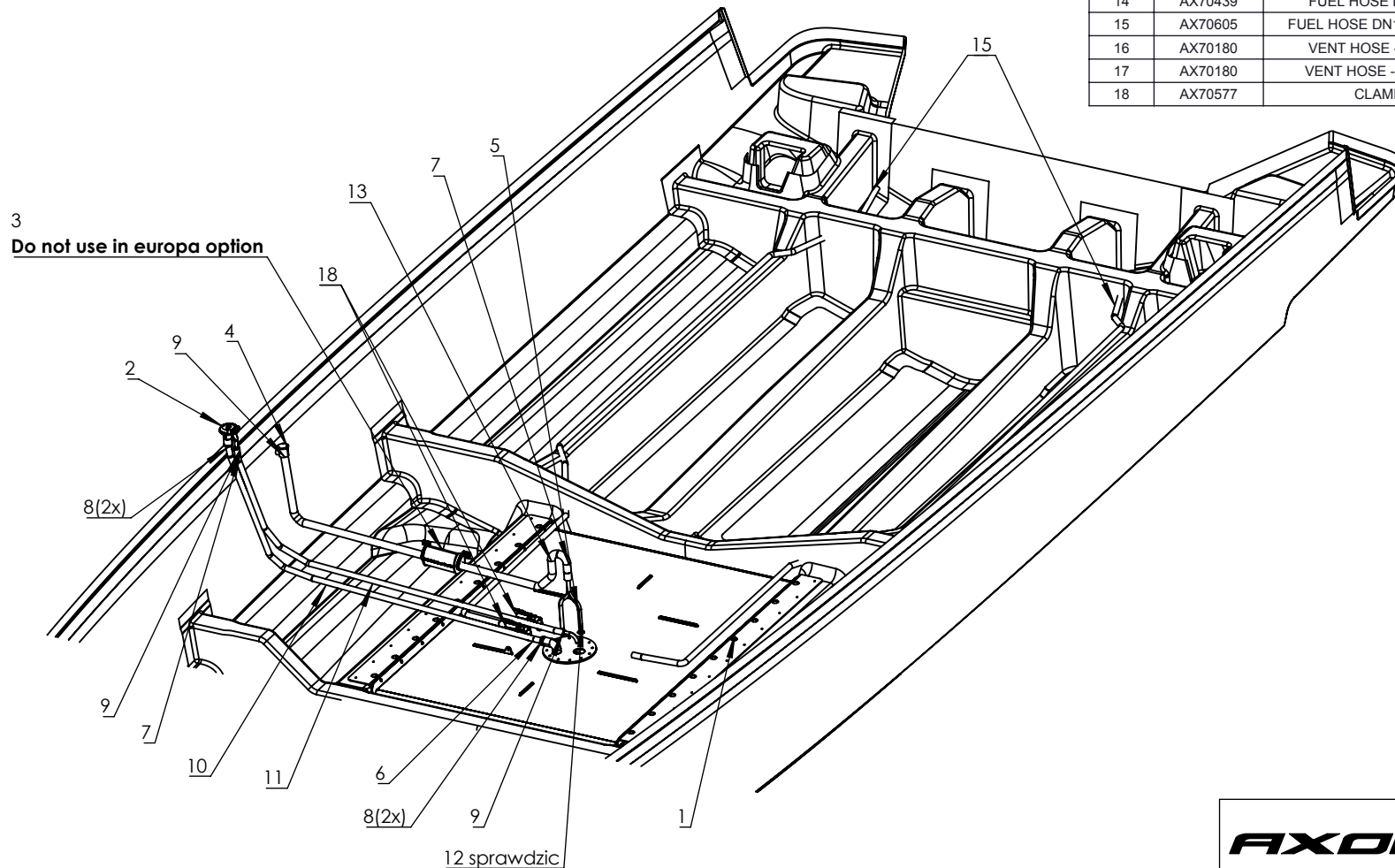

NOTICE:

1. Do NOT use Sikalfex on fuel Hoses
2. See instruction **INS006/AX37-Sh800** for **FUEL PERKO** instalation
3. See instruction **"INSTALLATION INSTRUCTIONS FOR HOSE CLAMPS"**

		BOAT MODEL	
		AXOPAR 37L	
DRAWN	Maciej Buklaho	TITLE	
MODEL ASSEMBLY	Maciej Buklaho	FUEL SYSTEM - PERKO	
APPROVED	PROTOTYPE	DATE	DWG. NO.
		02.07.2019	SY-AX37L-01
		Rev.	SHEET
		A	1 OF 1

FIND NO	CODE	PART LIST	LENGHT [m]	QTY
1	AX81692	FUEL TANK		1
2	AX80817	FUEL INLET		1
3	AX81635	CARBON CANISTER		1
4	AX81636	P-TRAP		1
5	AX81720	TEE-ALU		1
6	AX81632	ONE DIRECTION VALVE FI 38		1
7	AX81633	ONE DIRECTION VALVE FI 16		1
8	AX70575	CLAMP 35X50		4
9	AX70576	CLAMP 16X27		10
10	AX70440	FUEL HOSE DN38 - FUEL INLET	4,8	1
11	AX70439	FUEL HOSE DN16 - MAIN VENT	4,7	1
12	AX70439	FUEL HOSE DN16 - TEE	0,1	11
13	AX70439	FUEL HOSE DN16 - CARBON CANISTER	1,9	1
14	AX70439	FUEL HOSE DN16 - P-TRAP	0,1	1
15	AX70605	FUEL HOSE DN12 - FUEL POWER	11,6	1
16	AX70180	VENT HOSE - AFT - FI75MM		1
17	AX70180	VENT HOSE - BOW - FI75MM		1
18	AX70577	CLAMP 12X22		2

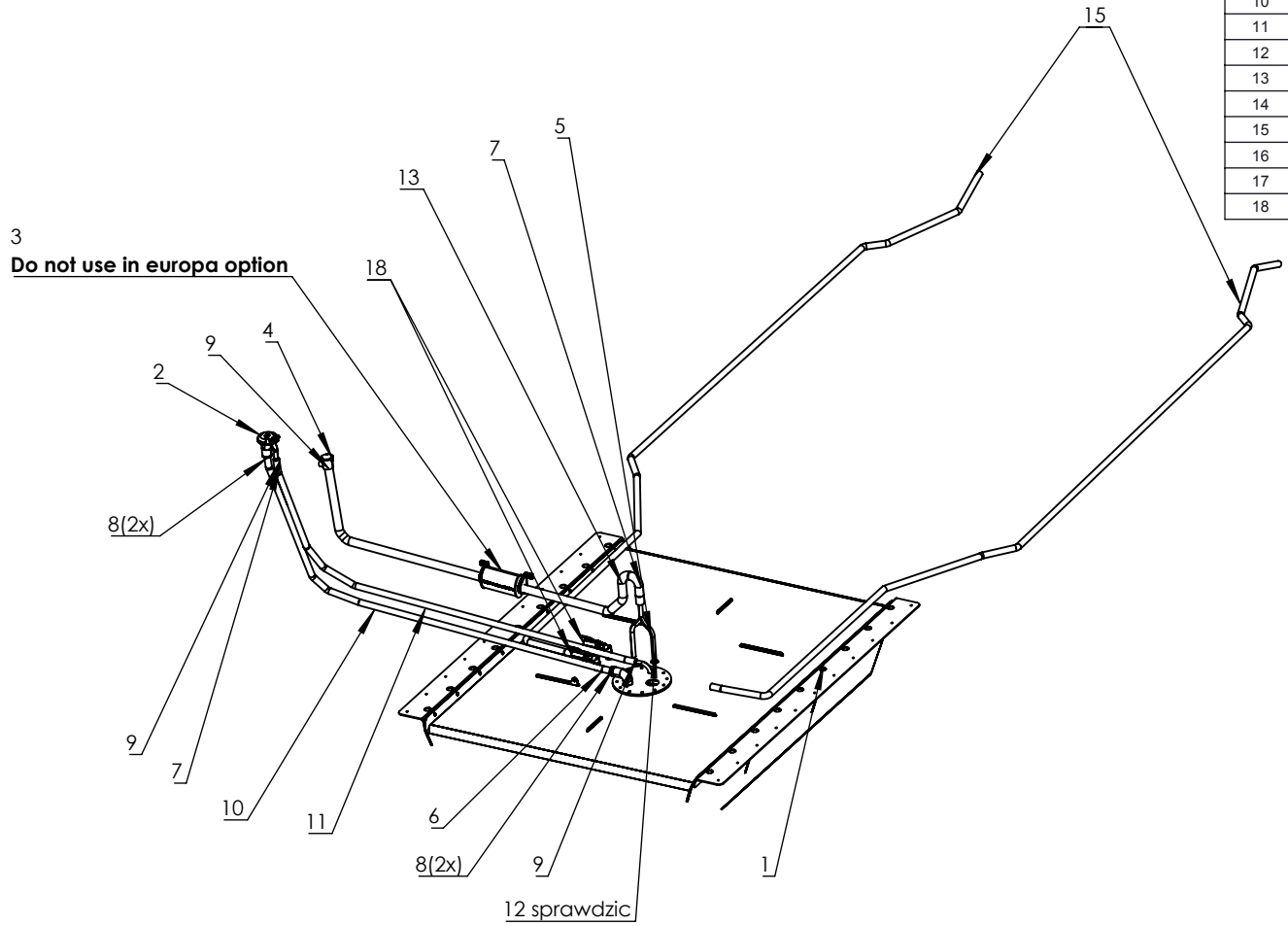

- NOTICE:
1. Do NOT use Sikalfex on fuel Hoses
 2. See instruction **INS006/AX37-Sh800** for **FUEL PERKO** instalation
 3. See instruction "**INSTALLATION INSTRUCTIONS FOR HOSE CLAMPS**"

		BOAT MODEL	
		AXOPAR 37L	
DRAWN	Maciej Buklaho	TITLE	
MODEL ASSEMBLY	Maciej Buklaho	FUEL SYSTEM - PERKO	
APPROVED	PROTOTYPE	DATE	DWG NO.
		02.07.2019	SY-AX37L-01
		Rev.	SHEET
		A	1 OF 1

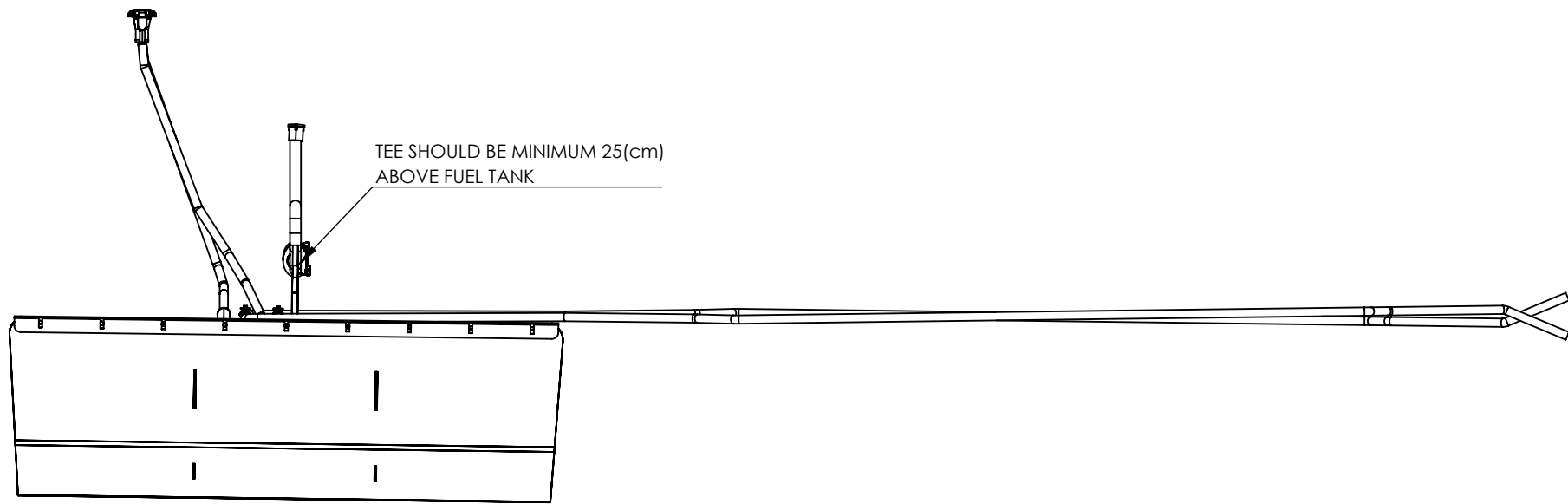

TEE SHOULD BE MINIMUM 25(cm)
ABOVE FUEL TANK

Instal here:
One-Direction Valve D16

Instal here:
One-Direction Valve D36

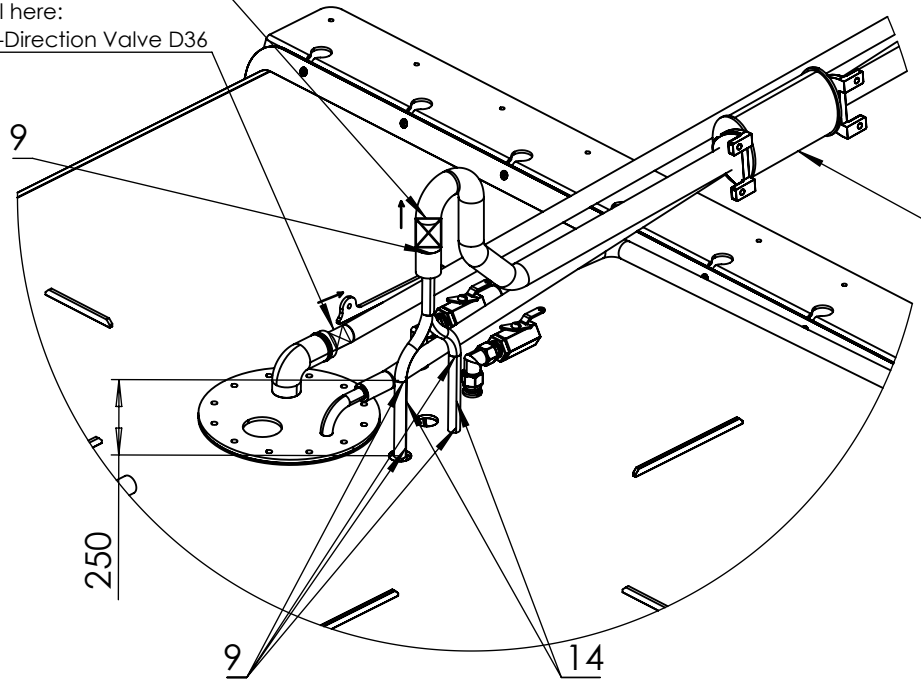

3
Do not use in europa option

NOTICE:

1. Do NOT use Sikalfex on fuel Hoses
2. One direction Valve should be instaled in vertical position, or it is allowed to have 30deg tolerance from vertical position
3. Fuel hose should have minimum 3deg drop
4. When Hose is bended its need to keep clearance
5. See instruction **INS006/AX37-Sh800** for **FUEL PERKO** instalation
6. See instruction "**INSTALLATION INSTRUCTIONS FOR HOSE CLAMPS**"

		BOAT MODEL	
		AXOPAR 37L	
DRAWN	Maciej Bukłaho	TITLE	
MODEL ASSEMBLY	Maciej Bukłaho	FUEL SYSTEM - PERKO	
APPROVED	PROTOTYPE	DATE	DWG NO.
		02.07.2019	SY-AX37L-01
		Rev.	SHEET
		A	1 OF 1

11 Appendix III: Electrical diagrams

Axopar 37 MY20

Axopar 37 MY20 SHADOW

ELECTRICAL DIAGRAM / PRODUCTION DRAWINGS

DOCUMENT INCLUDES:
 BOAT HARNESS / PANEL GENERAL LAYOUT
 ELECTRICAL STRUCTURE OF 12V DC SYSTEM (EURO/USA)
 12V DC DIAGRAM
 PRODUCTION DRAWINGS

NOTE! ALL CABLE AREAS ARE IN METRIC SYSTEM (mm2).

REVISION G23

10.10.2023	PF	F22: 2004916; Not modified	Date	26.4.2019	 Copyright by	Axopar			
20.2.2024	PF	G23; 2005054; Not modified	Drawing by	TuM		Boat	Sub-product code	Product code	Project ID
17.2.2023	RK	F21: NOT MODIFIED	Sheet rev.	23		37 MY20	COVER	HL	1 / 213 Sheet
Date of modification	Modified by	Description	Project rev.	G		Boat model	Title	Loc	
1	2	3	4	5	6	7	8		

STRUCTURE OF 12Vdc SYSTEM, EURO/USA

12Vdc HARNESS STRUCTURE:

LEGEND:
(APPLIES ONLY THIS PAGE)

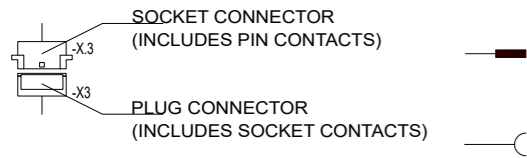

OR

ALL PRODUCTS TIED "OR" - LABEL ARE ALTERNATIVE OPTIONS DEPENDING THE SET-UP OR MODEL OF BOAT. BOTH PRODUCTS WITH "OR" - LABEL CANNOT INSTALL TO BOAT.

NOTE! CONNECTOR NAME LIKE "X3" IS HEADER ONLY FOR EXAMPLE X3 CONNECTORS INCLUDES VARIOUS CONNECTORS: X3a, X3b, X3c, X3d, X3e, X3f and X3g. MORE DETAILS IN ELECTRIC SCHEMATIC AND PRODUCTION DRAWINGS.

SYSTEM GROUPS:
NOTICE!
ALL PRODUCTS INCLUDED INDICATED SYSTEM GROUP NEED TO INSTALL TO BOAT.

● BOW BATTERY SYSTEM PRODUCTS

12Vdc BATTERY BOX PRODUCTS: STANDARD

SEPARATE PANELS:

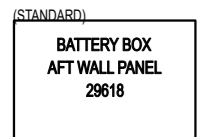
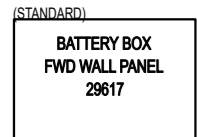

BATTERY CABLES:

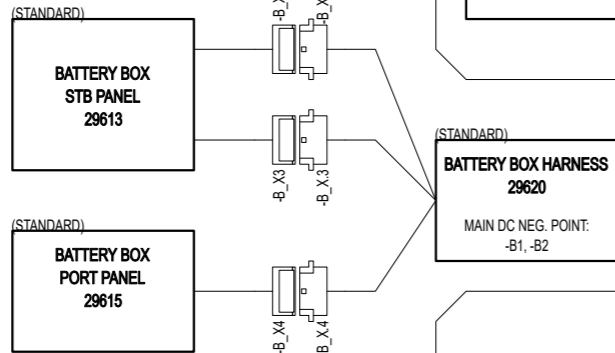
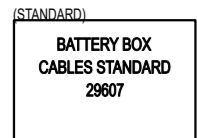

29637 BATTERY BOX STANDARD

12Vdc SOLAR PANEL SYSTEM:

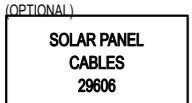

12Vdc BATTERY BOX PRODUCTS: OPTIONAL

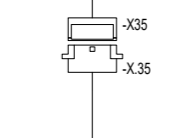
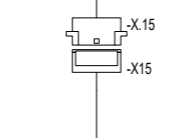
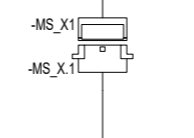
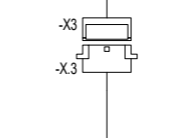
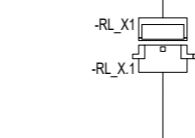
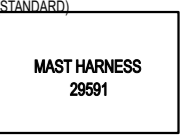
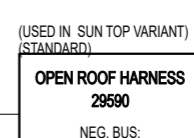
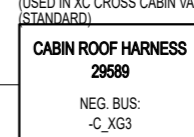
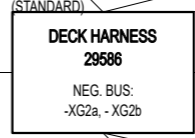
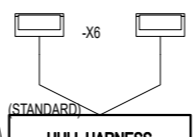
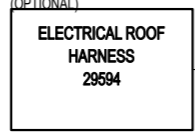
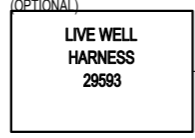
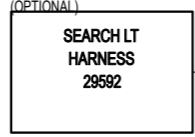
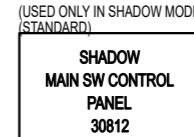
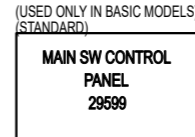
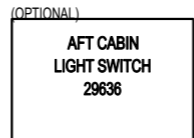
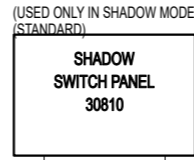
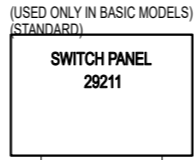
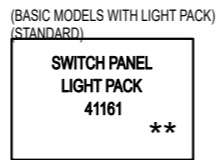
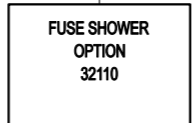
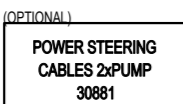
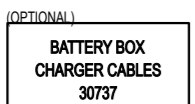
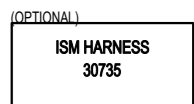
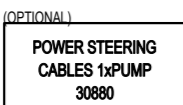
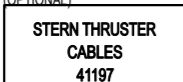
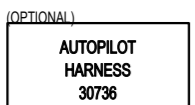
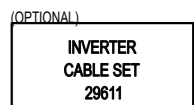

12Vdc BATTERY CABLES:

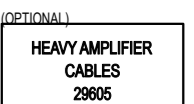
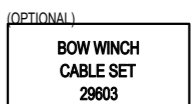
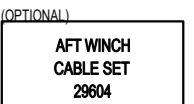
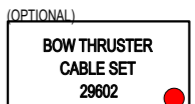
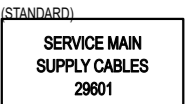
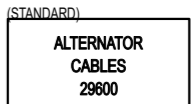

** = must be used together, may not be mixed with standard lighting products

10.10.2023	PF	F22: 2004916; Not modified
20.2.2024	PF	G23; 2005054; Added: 41158, 41159, 41160, 41161, 41196, 41197
17.2.2023	RK	F21: NOT MODIFIED
Date of modification	Modified by	Description

Date	14.1.2019
Drawing by	TuM
Sheet rev.	23
Project rev.	G



Copyright by

Axopar	Boat	Sub-product code	Product code	Project ID
	37 MY20	EL. STRUCTURE - 12Vdc SYSTEM, EURO/USA	HL	2 / 213
	Boat model	Title	Loc	Sheet

T-TOP (TT) HARNESS/ PANEL GENERAL LAYOUT

TOP VIEW

NOTE!
LAYOUT GIVES ONLY APPROXIMATE LOCATION OF PANEL AND HARNESS.

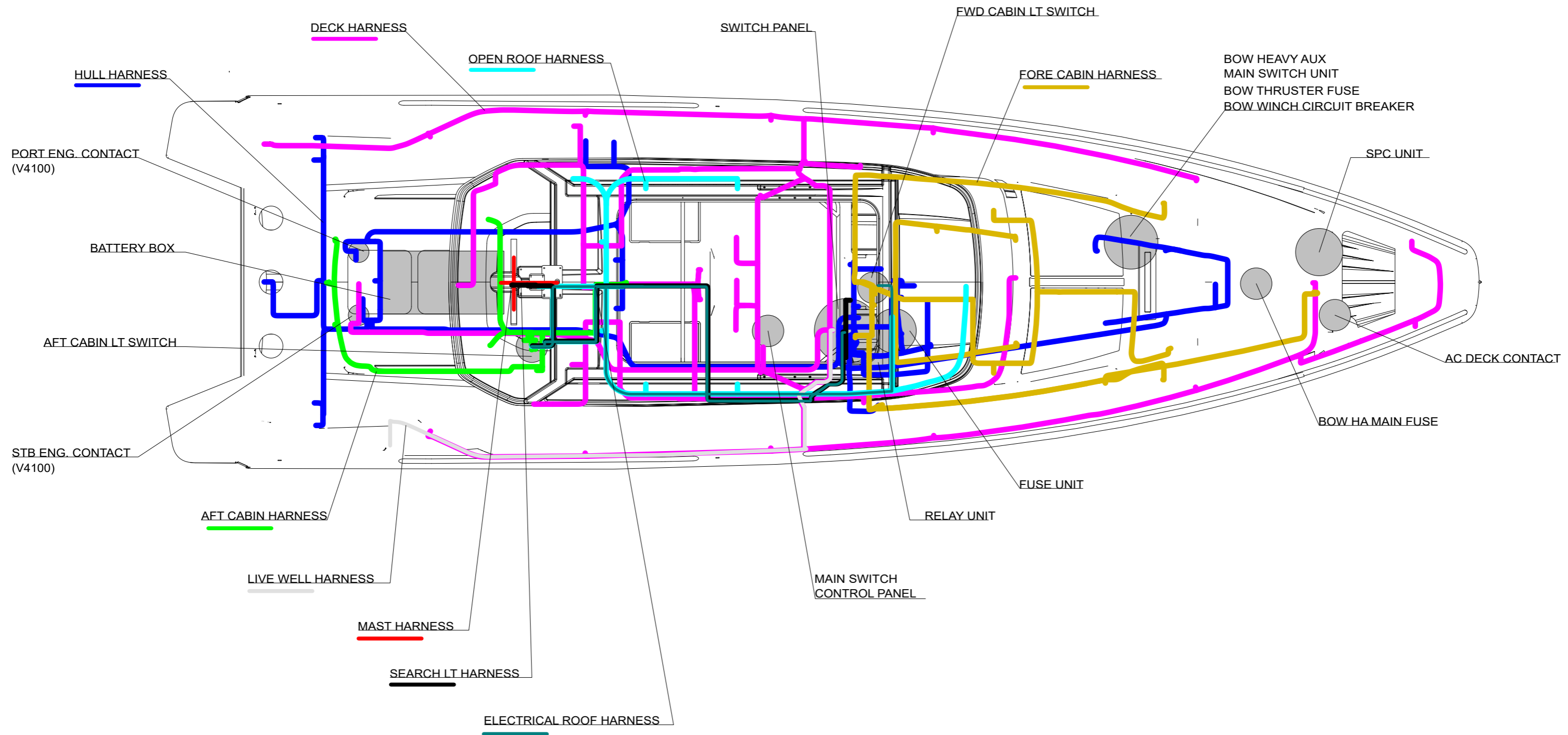

10.10.2023	PF	F22: 2004916; Not modified	Date	14.1.2019	 NAVIX designed solutions	Axopar			
20.2.2024	PF	G23; 2005054; Not modified	Drawing by	TuM		Boat	37 MY20	Sub-product code	Product code
17.2.2023	RK	F21: NOT MODIFIED	Sheet rev.	23	Copyright by		HARNESS LAYOUT - T-TOP (TT)	HL	3 / 213
Date of modification	Modified by	Description	Project rev.	G	Boat model			Loc	

HULL HARNESS - LAYOUT

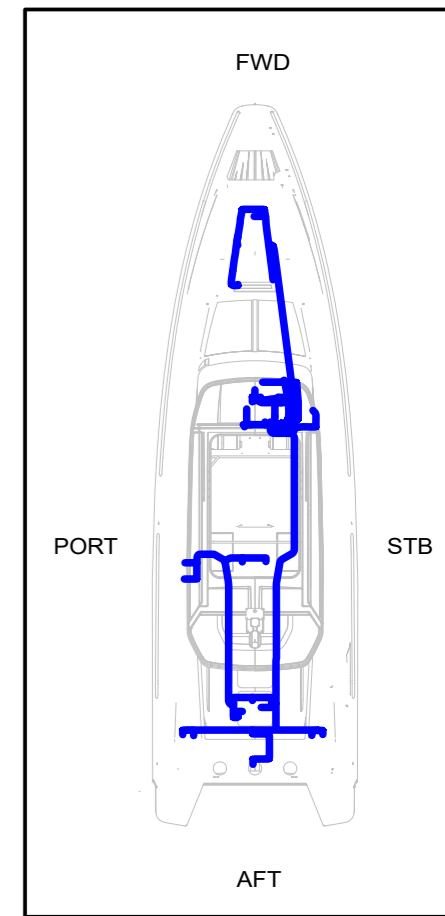
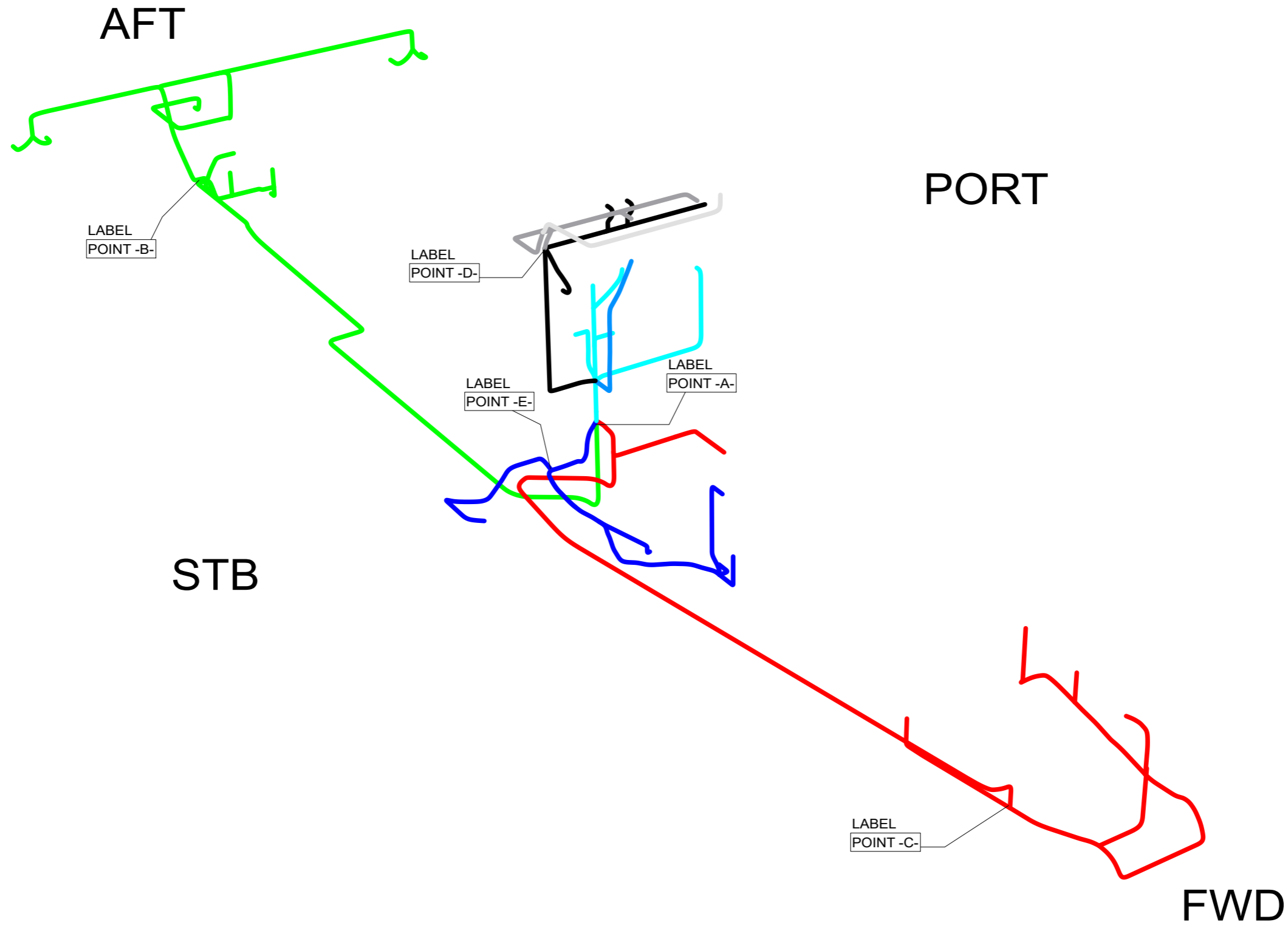



10.10.2023	PF	F22: 2004916; Not modified	Date	2.5.2019	 NAVIX designed solutions	Axopar			
20.2.2024	PF	G23; 2005054; Not modified	Drawing by	TuM		Boat	37 MY20	Sub-product code	Product code
17.2.2023	RK	F21: NOT MODIFIED	Sheet rev.	23	Copyright by		HULL HARNESS - LAYOUT Title	HL	4 / 213 Sheet
Date of modification	Modified by	Description	Project rev.	G	Boat model	37 MY20		Loc	

T-TOP (TT) HARNESS/ PANEL GENERAL LAYOUT

SIDE VIEW

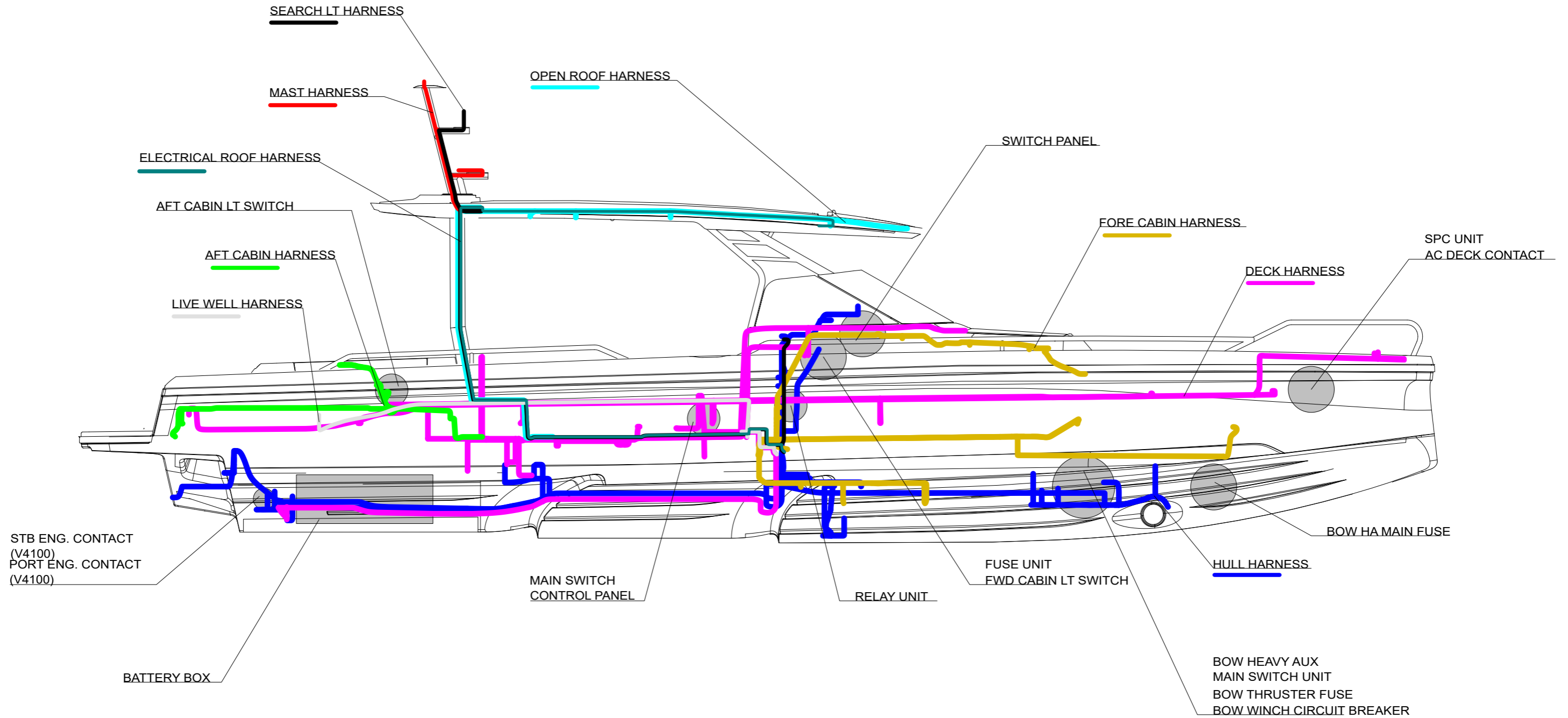
NOTE!
LAYOUT GIVES ONLY APPROXIMATE LOCATION OF PANEL AND HARNESS.



10.10.2023	PF	F22: 2004916; Not modified	Date	11.7.2019		Axopar			
20.2.2024	PF	G23; 2005054; Not modified	Drawing by	TuM		Boat	37 MY20	Sub-product code	Product code
17.2.2023	RK	F21: NOT MODIFIED	Sheet rev.	23	Copyright by		HARNESS LAYOUT - T-TOP (TT)	HL	5 / 213
Date of modification	Modified by	Description	Project rev.	G	Boat model			Loc	

DECK HARNESS - LAYOUT

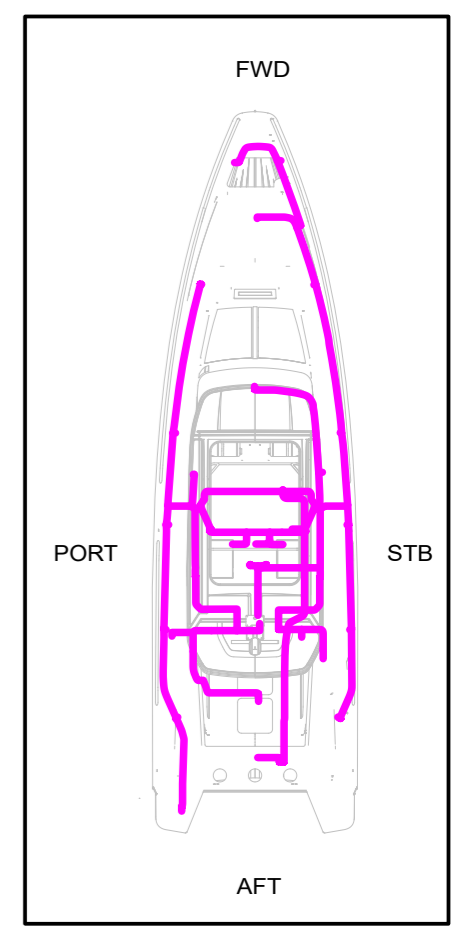
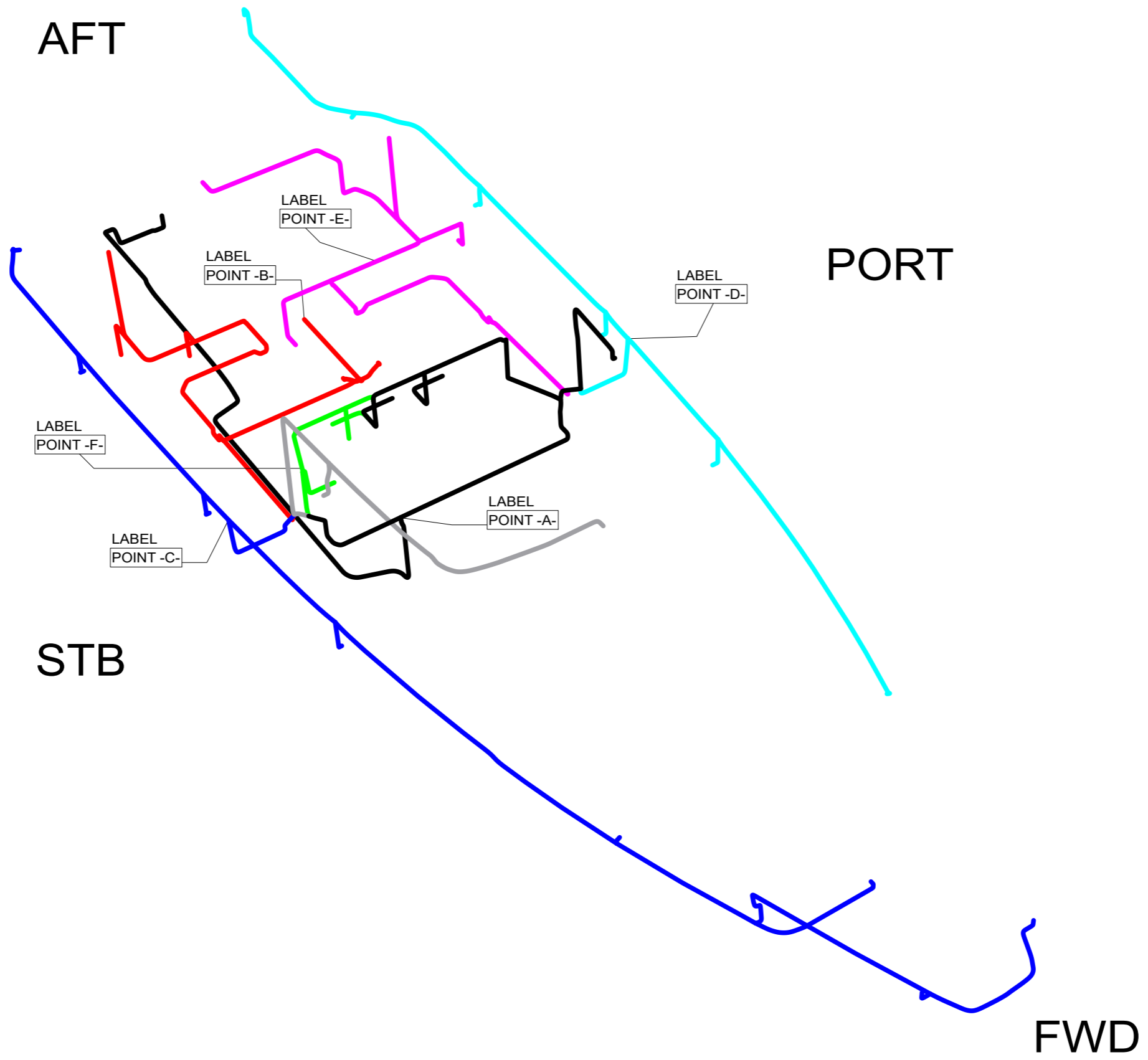

10.10.2023	PF	F22: 2004916; Not modified
20.2.2024	PF	G23; 2005054; Not modified
17.2.2023	RK	F21: NOT MODIFIED
Date of modification	Modified by	Description

Date	2.5.2019
Drawing by	TuM
Sheet rev.	23
Project rev.	G





Axopar
Boat
37 MY20
Boat model

Sub-product code	Product code	Project ID
DECK HARNESS - LAYOUT		
Title	HL	
	Loc	

6 / 213	
Sheet	

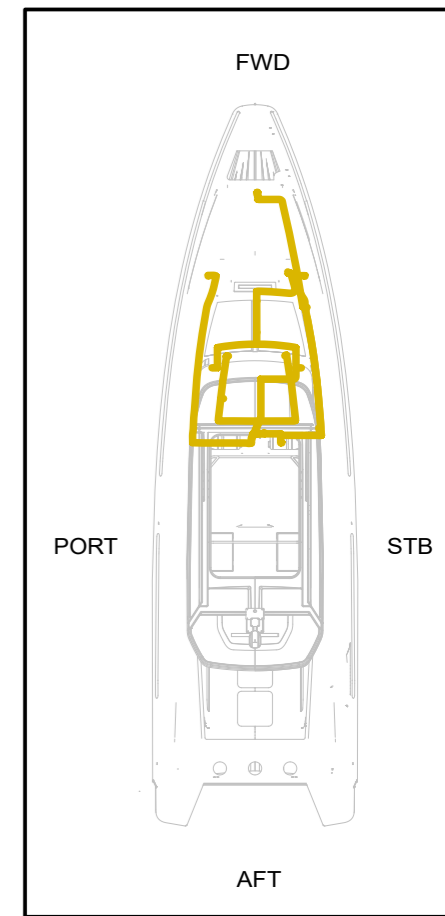
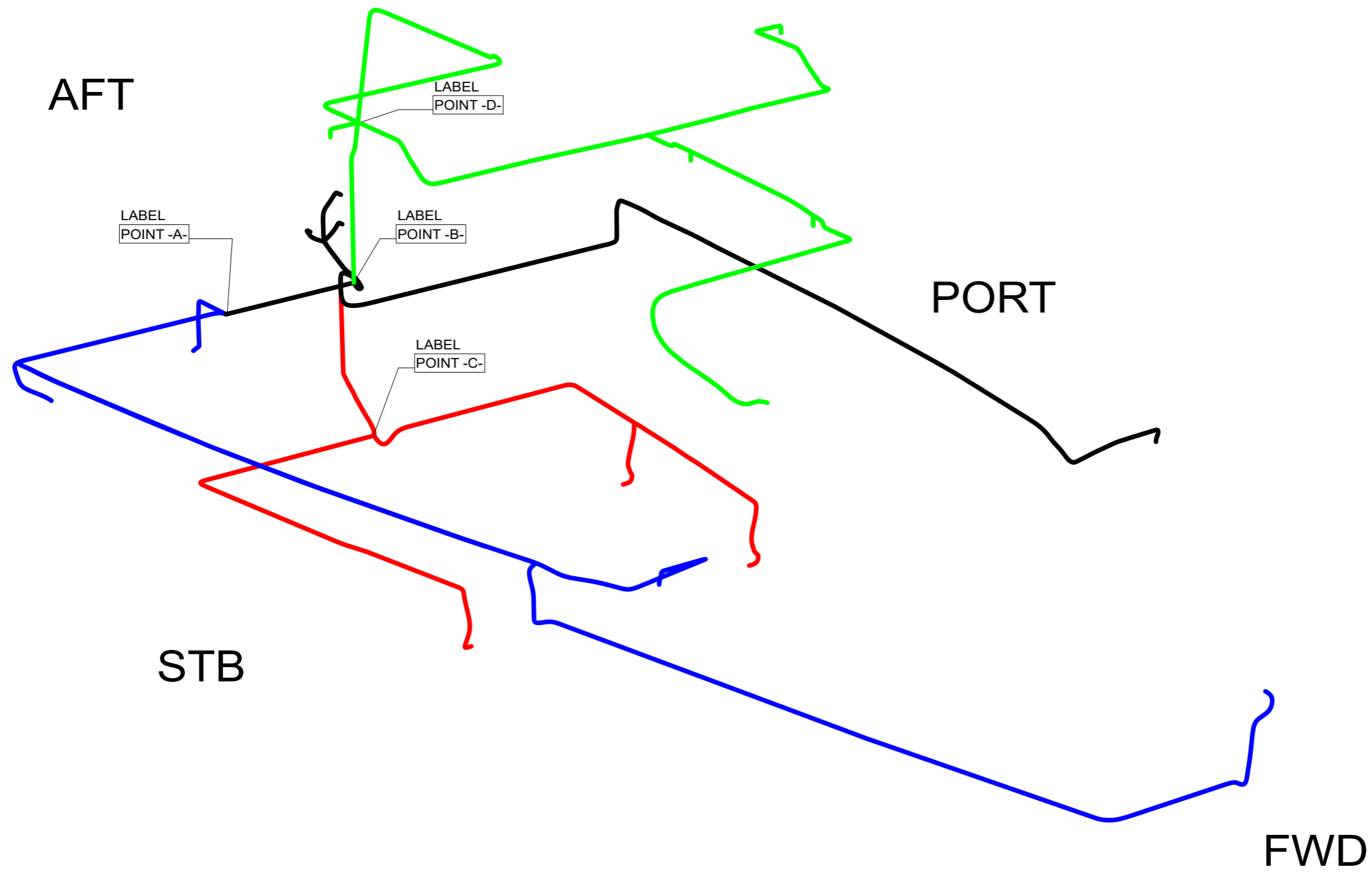
FORE CABIN HARNESS - LAYOUT



10.10.2023	PF	F22: 2004916; Not modified	Date	14.7.2019		Axopar			
20.2.2024	PF	G23; 2005054; Not modified	Drawing by	TuM		Boat			
17.2.2023	RK	F21: NOT MODIFIED	Sheet rev.	23	Copyright by	37 MY20	FORE CABIN HARNESS	TL	7 / 213
Date of modification	Modified by	Description	Project rev.	G		Boat model	LAYOUT	Loc	Sheet

AFT CABIN HARNESS - LAYOUT

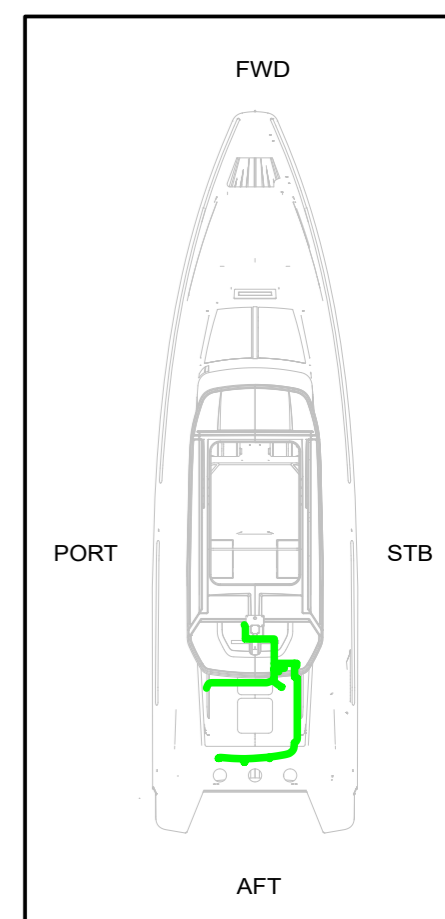
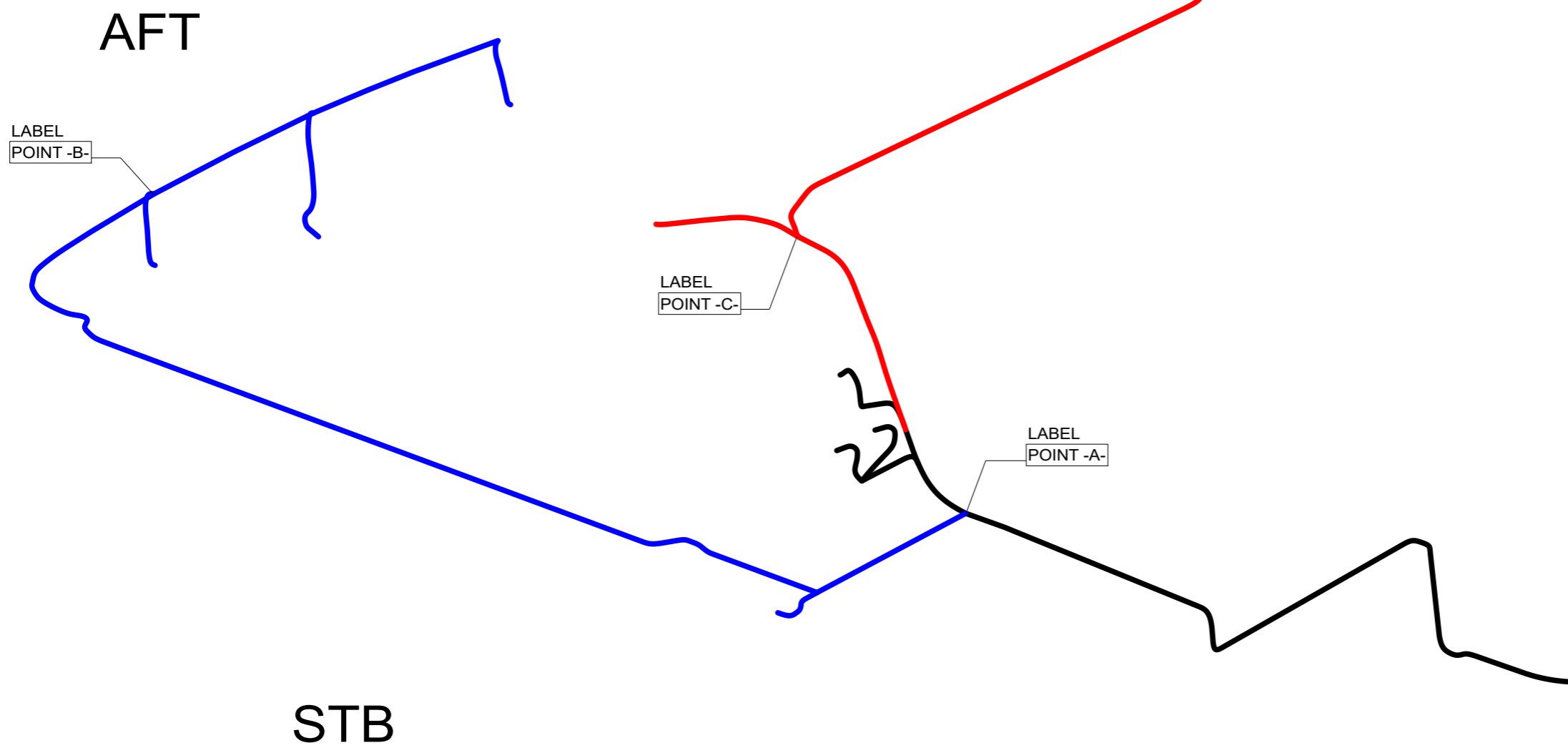

10.10.2023	PF	F22: 2004916; Not modified	Date	2.5.2019
20.2.2024	PF	G23; 2005054; Not modified	Drawing by	TuM
17.2.2023	RK	F21: NOT MODIFIED	Sheet rev.	23
Date of modification	Modified by	Description	Project rev.	G



Axopar				
Boat	37 MY20	Sub-product code	Product code	Project ID
Boat model		AFT CABIN HARNESS - LAYOUT	HL	8 / 213
		Title	Loc	Sheet

(OPEN/ CABIN) ROOF HARNESS - LAYOUT

AFT

PORT

STB

FWD

LABEL
POINT -B-

LABEL
POINT -C-

LABEL
POINT -A-

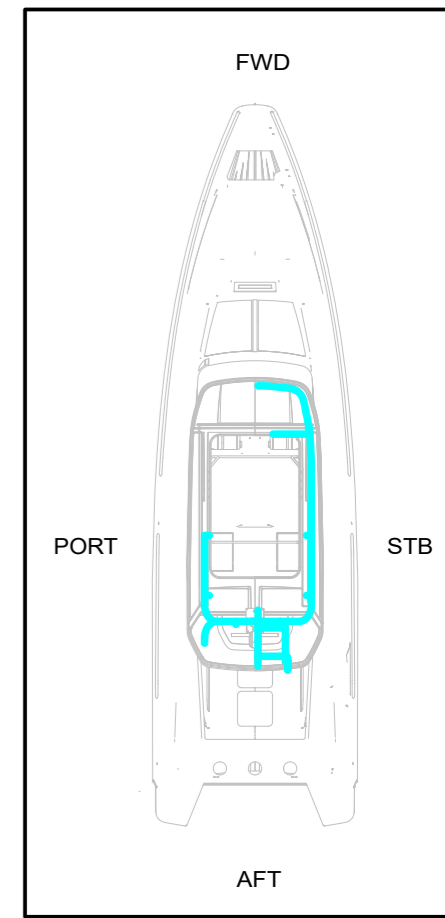



10.10.2023	PF	F22: 2004916; Not modified	Date	14.7.2019
20.2.2024	PF	G23; 2005054; Not modified	Drawing by	TuM
17.2.2023	RK	F21: NOT MODIFIED	Sheet rev.	23
Date of modification	Modified by	Description	Project rev.	G

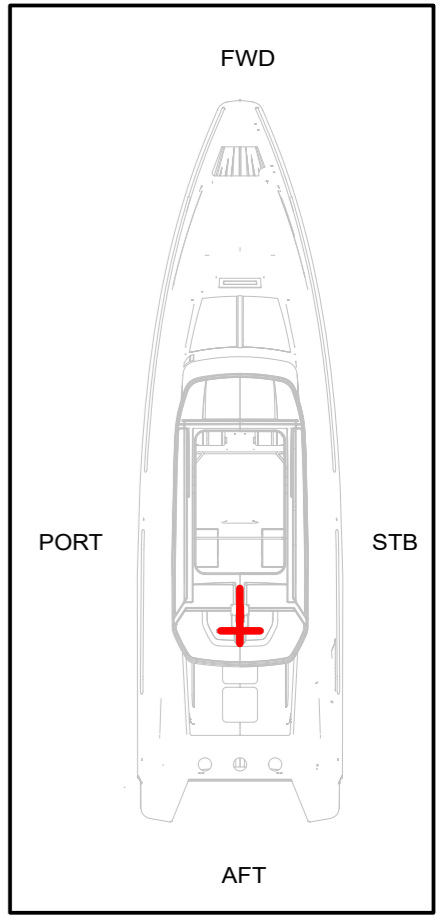
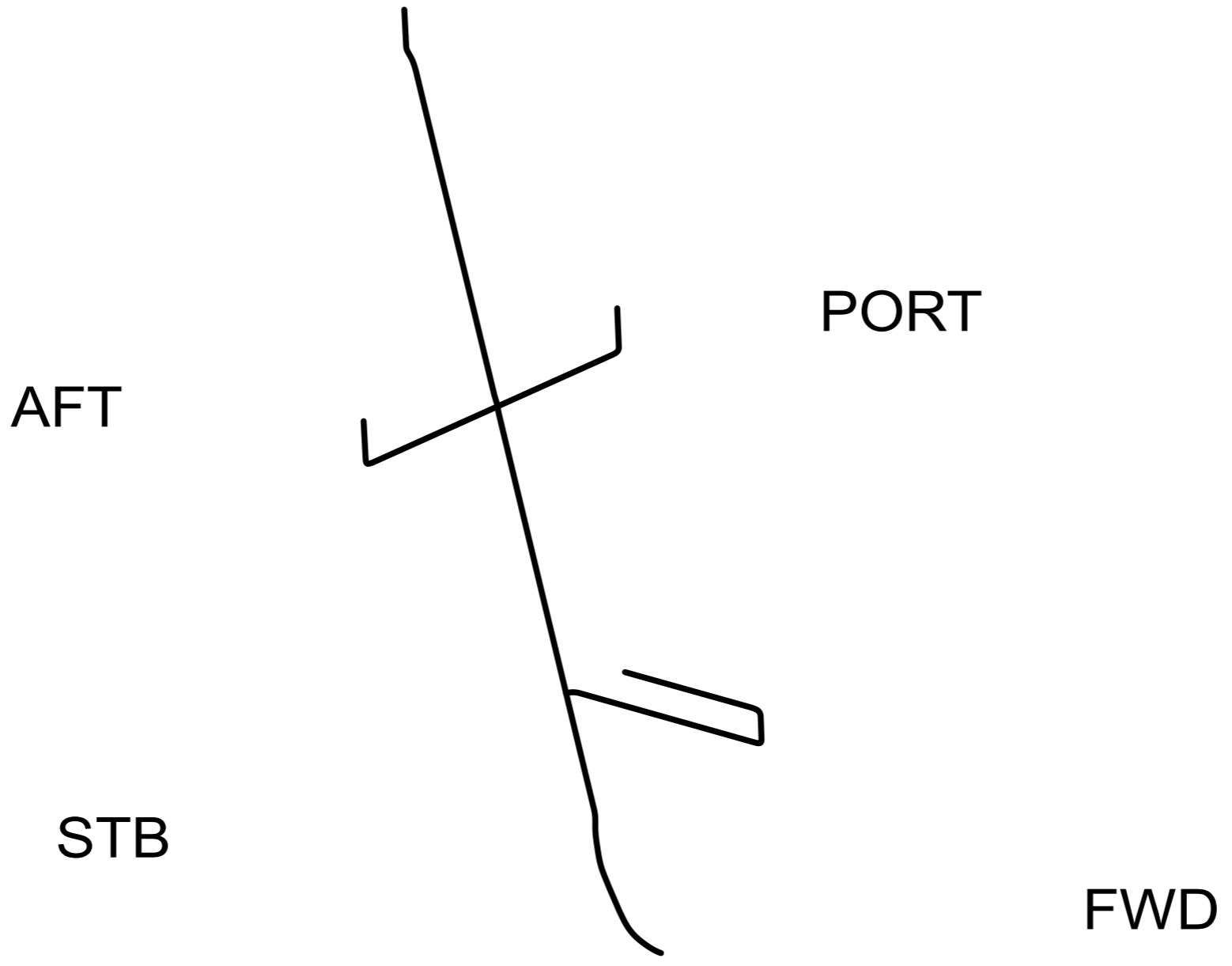

Axopar				
Boat	37 MY20	Sub-product code	Product code	Project ID
Boat model		ROOF HARNESS - LAYOUT	HL	9 / 213
		Title	Loc	Sheet

MAST HARNESS - LAYOUT



10.10.2023	PF	F22: 2004916; Not modified	Date	14.7.2019	 NAVIX designed solutions	Axopar			
20.2.2024	PF	G23; 2005054; Not modified	Drawing by	TuM		Boat	Sub-product code	Product code	Project ID
17.2.2023	RK	F21: NOT MODIFIED	Sheet rev.	23	Copyright by	37 MY20	MAST HARNESS - LAYOUT Title	HL	10 / 213 Sheet
Date of modification	Modified by	Description	Project rev.	G	Boat model	Loc			

SEARCH LT HARNESS - LAYOUT

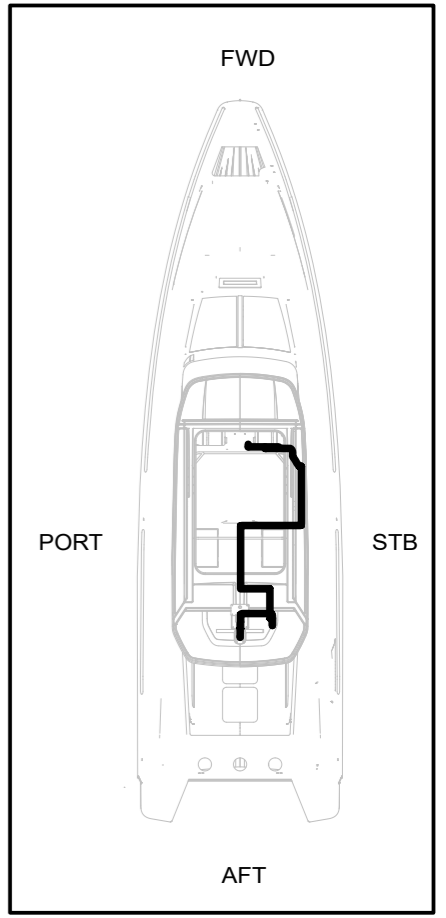
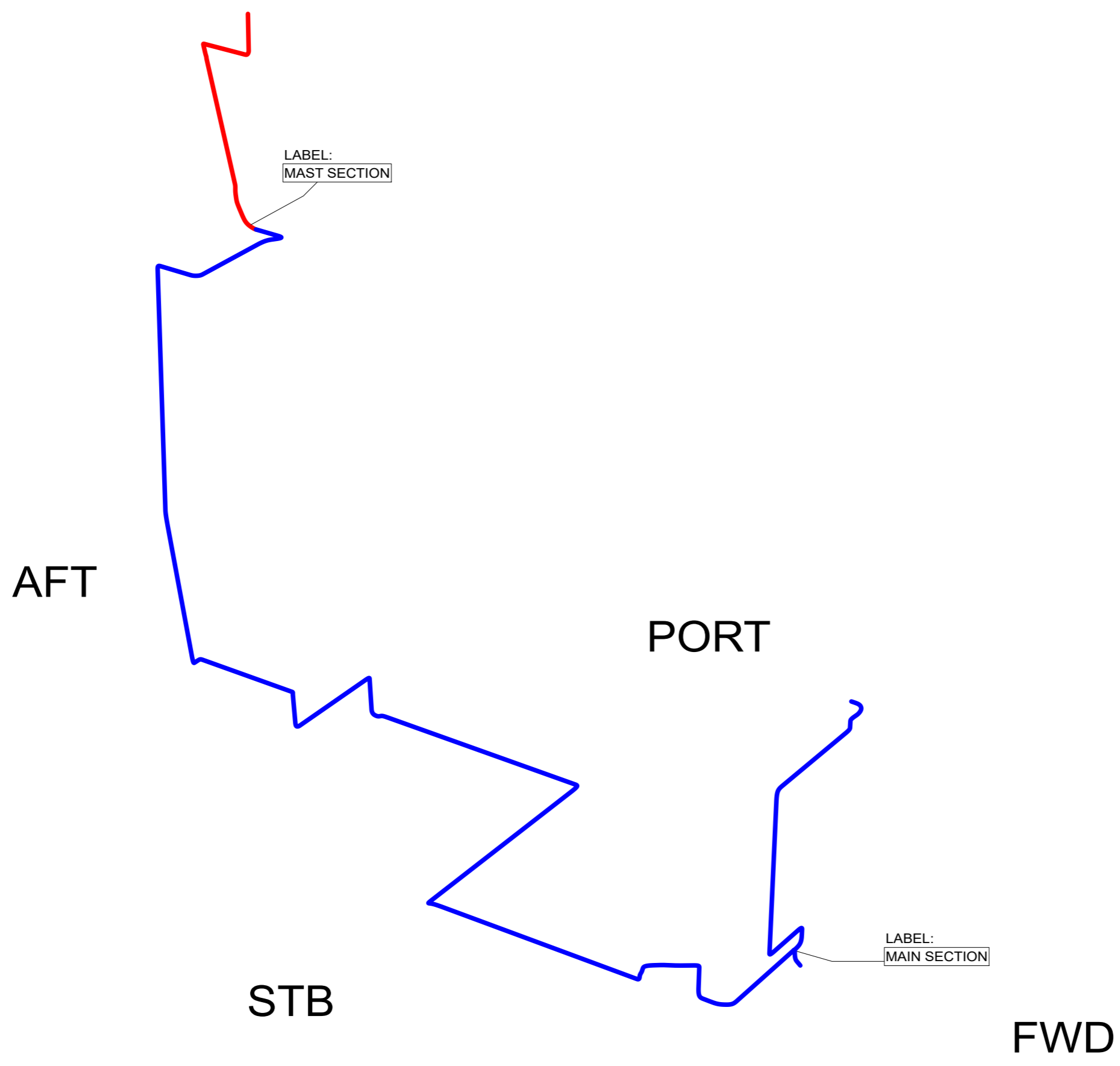

10.10.2023	PF	F22: 2004916; Not modified	Date	14.7.2019		Axopar			
20.2.2024	PF	G23; 2005054; Not modified	Drawing by	TuM		Boat	Sub-product code	Product code	Project ID
17.2.2023	RK	F21: NOT MODIFIED	Sheet rev.	23	Copyright by	37 MY20	SEARCH LT HARNESS - HL		11 / 213 Sheet
Date of modification	Modified by	Description	Project rev.	G		Boat model	Title	Loc	

LIVE WELL HARNESS - LAYOUT

AFT

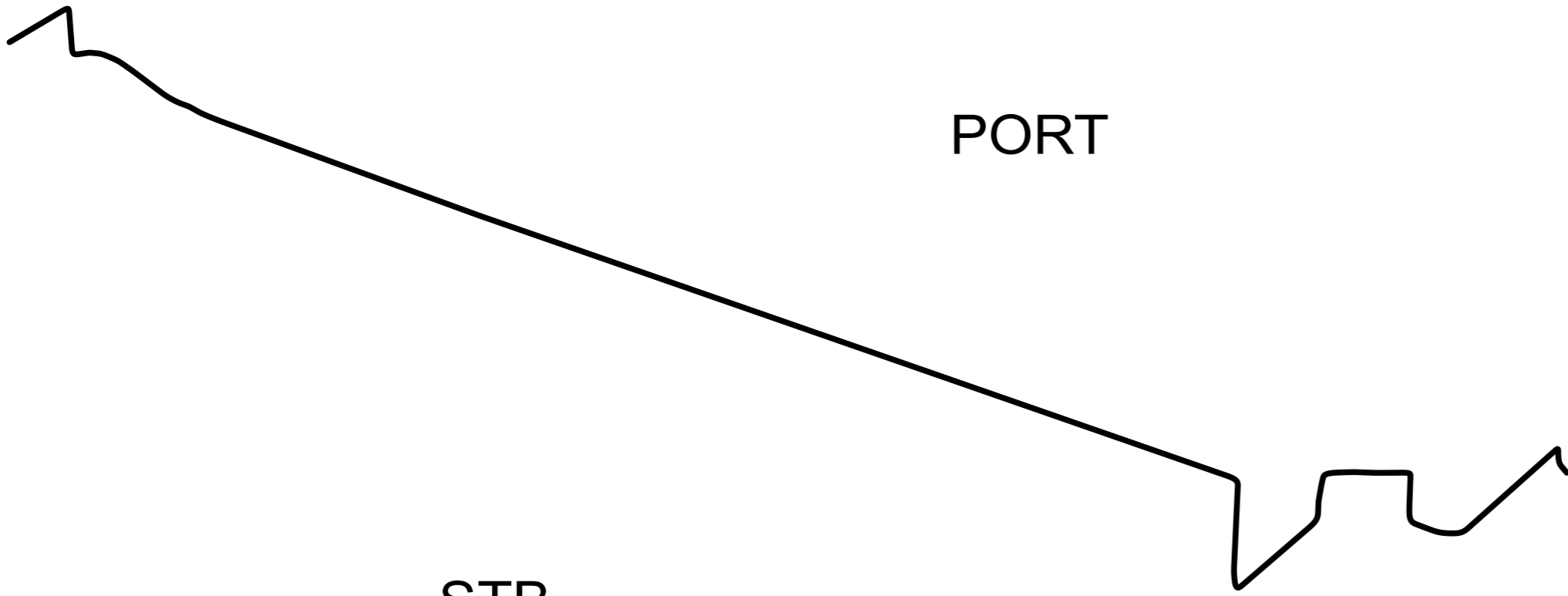

PORT

STB

FWD

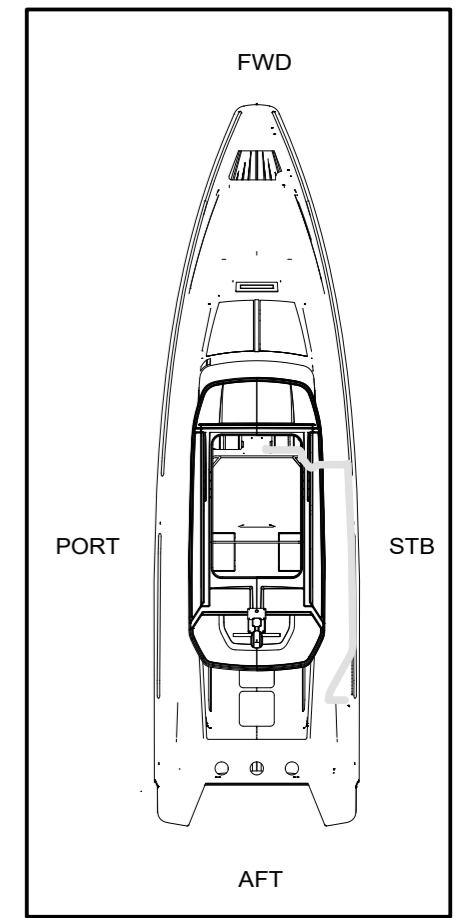

FWD

PORT

STB

AFT

10.10.2023	PF	F22: 2004916; Not modified	Date	14.7.2019		Axopar			
20.2.2024	PF	G23; 2005054; Not modified	Drawing by	TuM		Boat	Sub-product code	Product code	Project ID
17.2.2023	RK	F21: NOT MODIFIED	Sheet rev.	23		37 MY20	LIVE WELL HARNESS - LAYOUT	HL	12 / 213
Date of modification	Modified by	Description	Project rev.	G	Copyright by	Boat model	Title	Loc	Sheet

ELECTRICAL ROOF HARNESS - LAYOUT

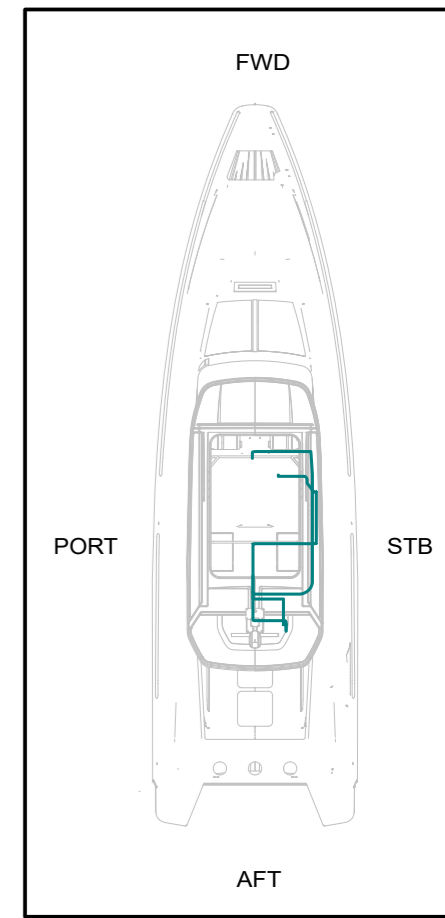
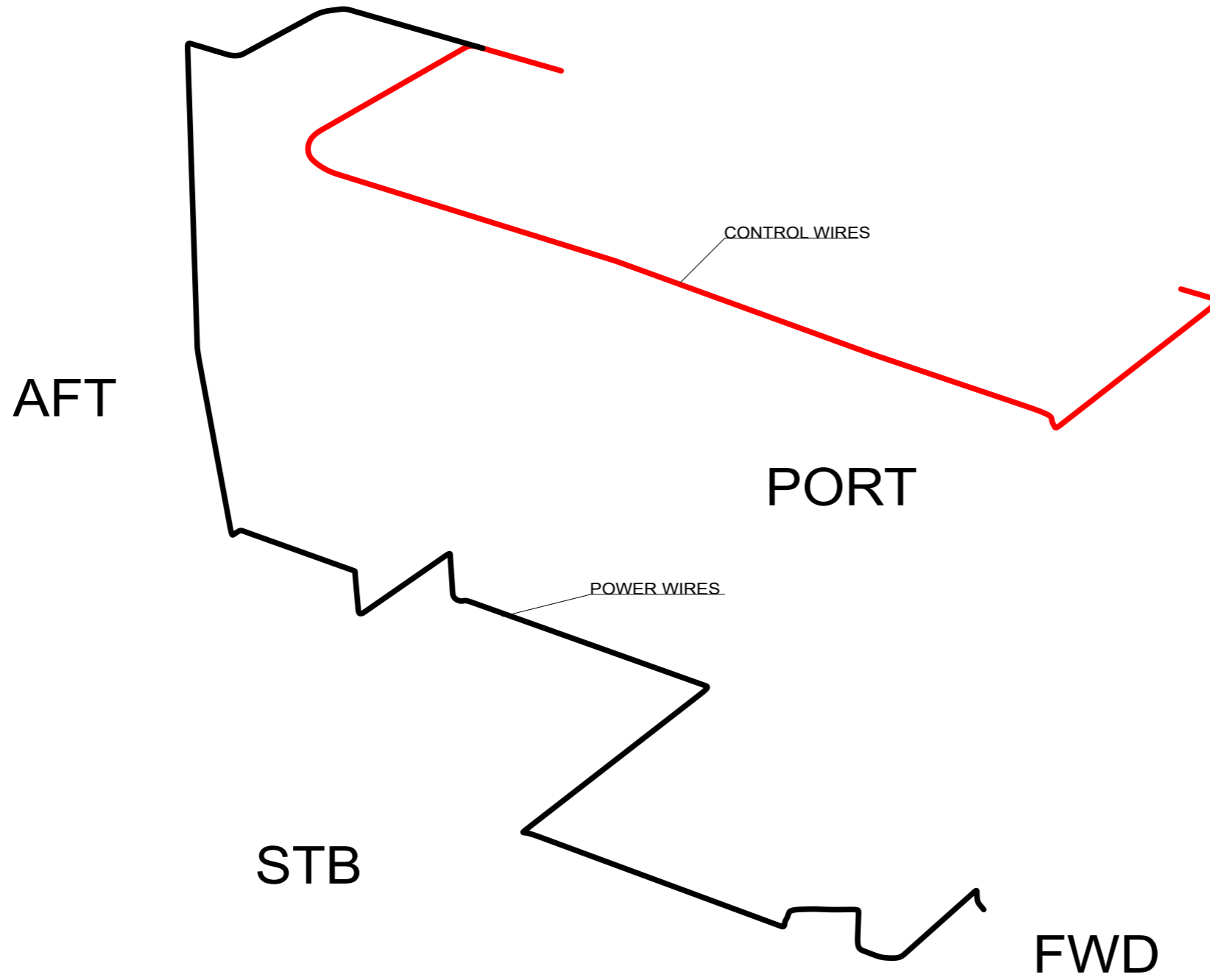

10.10.2023	PF	F22: 2004916; Not modified	Date	14.7.2019		Axopar			
20.2.2024	PF	G23; 2005054; Not modified	Drawing by	TuM		Boat	Sub-product code	Product code	Project ID
17.2.2023	RK	F21: NOT MODIFIED	Sheet rev.	23		37 MY20	ELECTRICAL ROOF HARNESS - LAYOUT		HL
Date of modification	Modified by	Description	Project rev.	G	Boat model	Title	Loc	Sheet	

BATTERY BOX PANEL LAYOUT

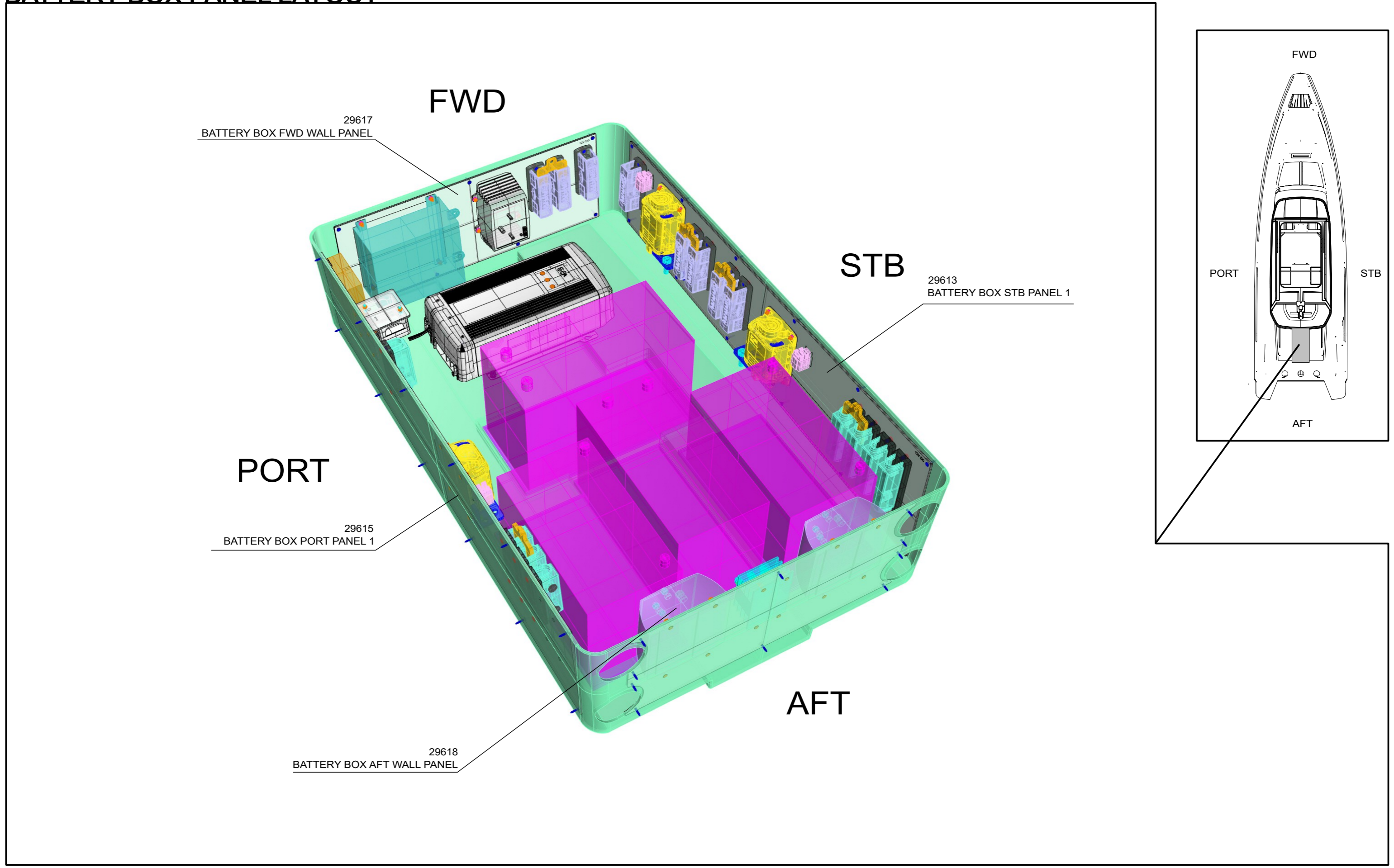

10.10.2023	PF	F22: 2004916; Not modified	Date	11.7.2019
20.2.2024	PF	G23; 2005054; Not modified	Drawing by	TuM
17.2.2023	RK	F21: NOT MODIFIED	Sheet rev.	23
Date of modification	Modified by	Description	Project rev.	G



Axopar			
Boat	37 MY20	Sub-product code	Product code
Boat model		BATTERY BOX - PANEL LAYOUT	Project ID
		HL	14 / 213
		Loc	Sheet

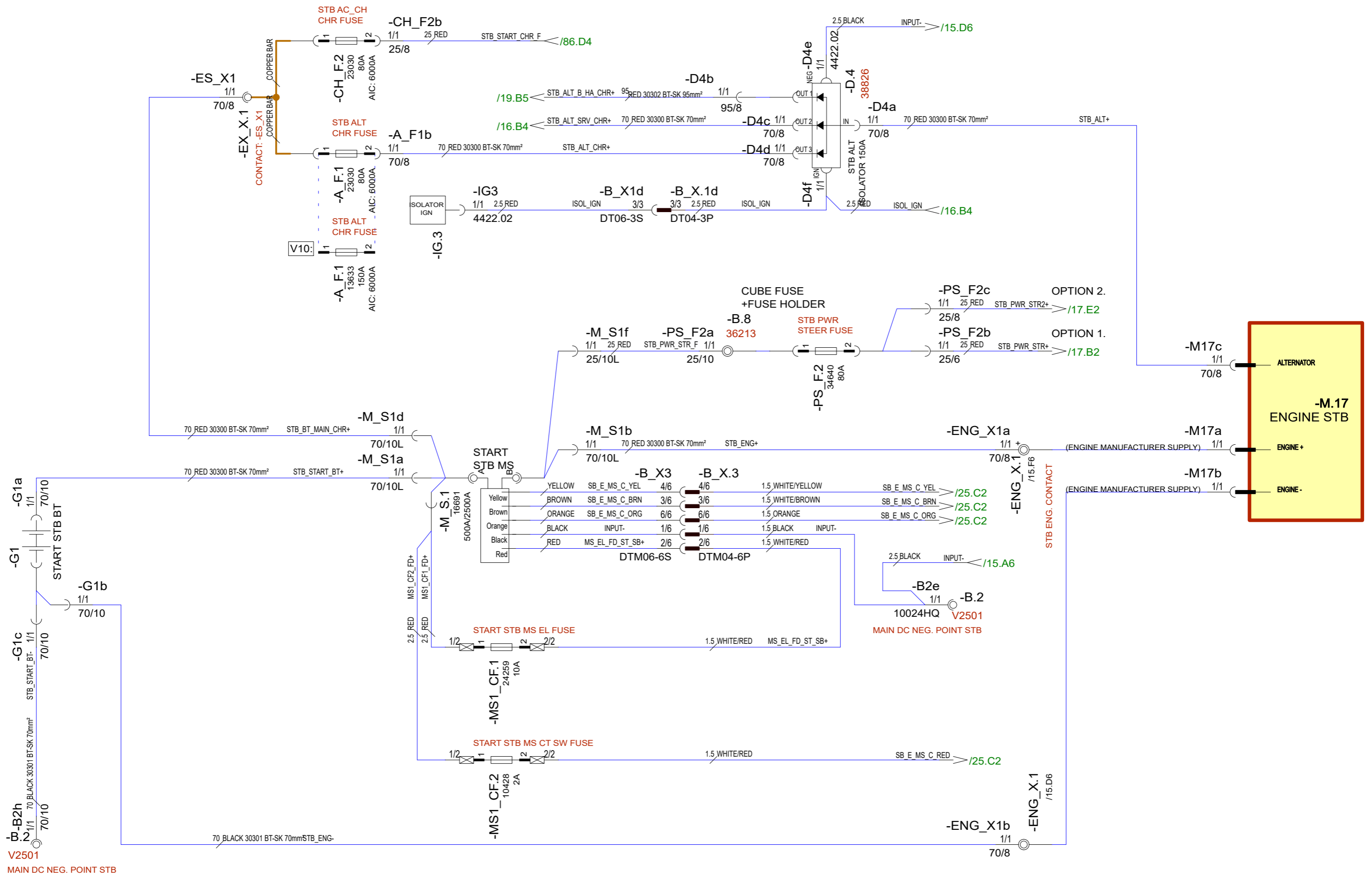

V2501
MAIN DC NEG. POINT STB

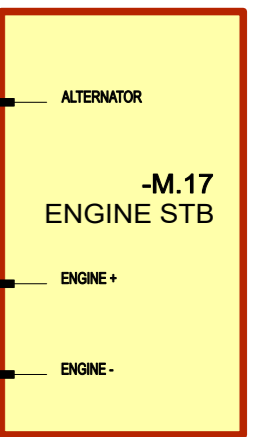

10.10.2023	PF	F22: 2004855; V10 update to cables and fusing, isolator	Date	14.1.2019		Axopar				
20.2.2024	PF	G23; 2005054; Isolator link to removed (bow th)	Drawing by	TuM		Boat	37 MY20	Sub-product code	Product code	Project ID
17.2.2023	RK	F21: NOT MODIFIED	Sheet rev.	23		Boat model		ENGINE STB - DIAGRAM	HL	15 / 213
Date of modification	Modified by	Description	Project rev.	G	Copyright by		Title	Loc	Sheet	

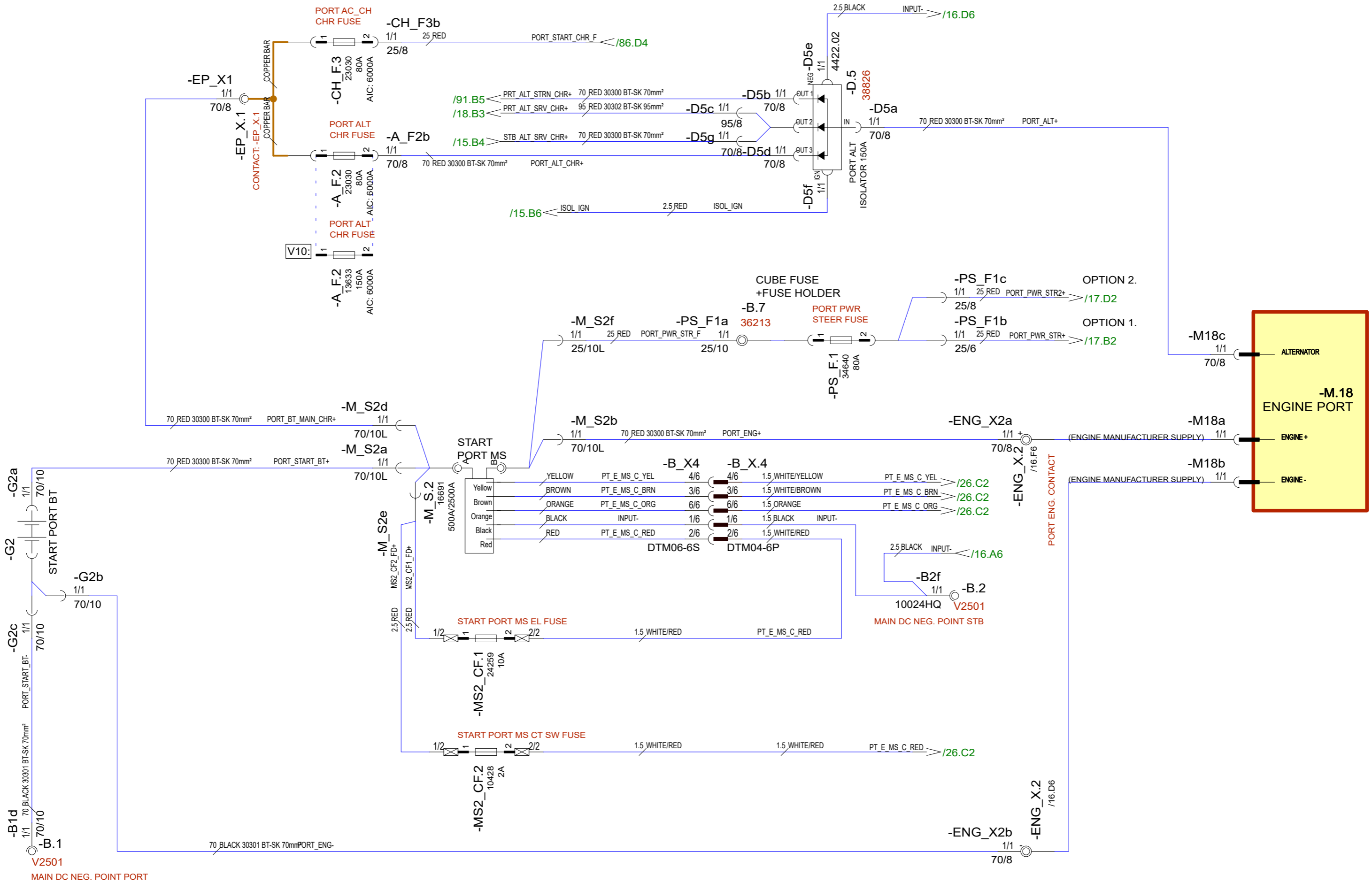

10.10.2023	PF	F22: 2004855; V10 update to cables and fusing, isolator	Date	14.1.2019
20.2.2024	PF	G23; 2005054; Isolator link removed->charging to stern batt	Drawing by	TuM
17.2.2023	RK	F21: NOT MODIFIED	Sheet rev.	23
Date of modification	Modified by	Description	Project rev.	G



Axopar	Boat	37 MY20	Boat model	Sub-product code	ENGINE PORT - DIAGRAM	Product code	HL	Project ID	16 / 213
				Title	Loc		Sheet		

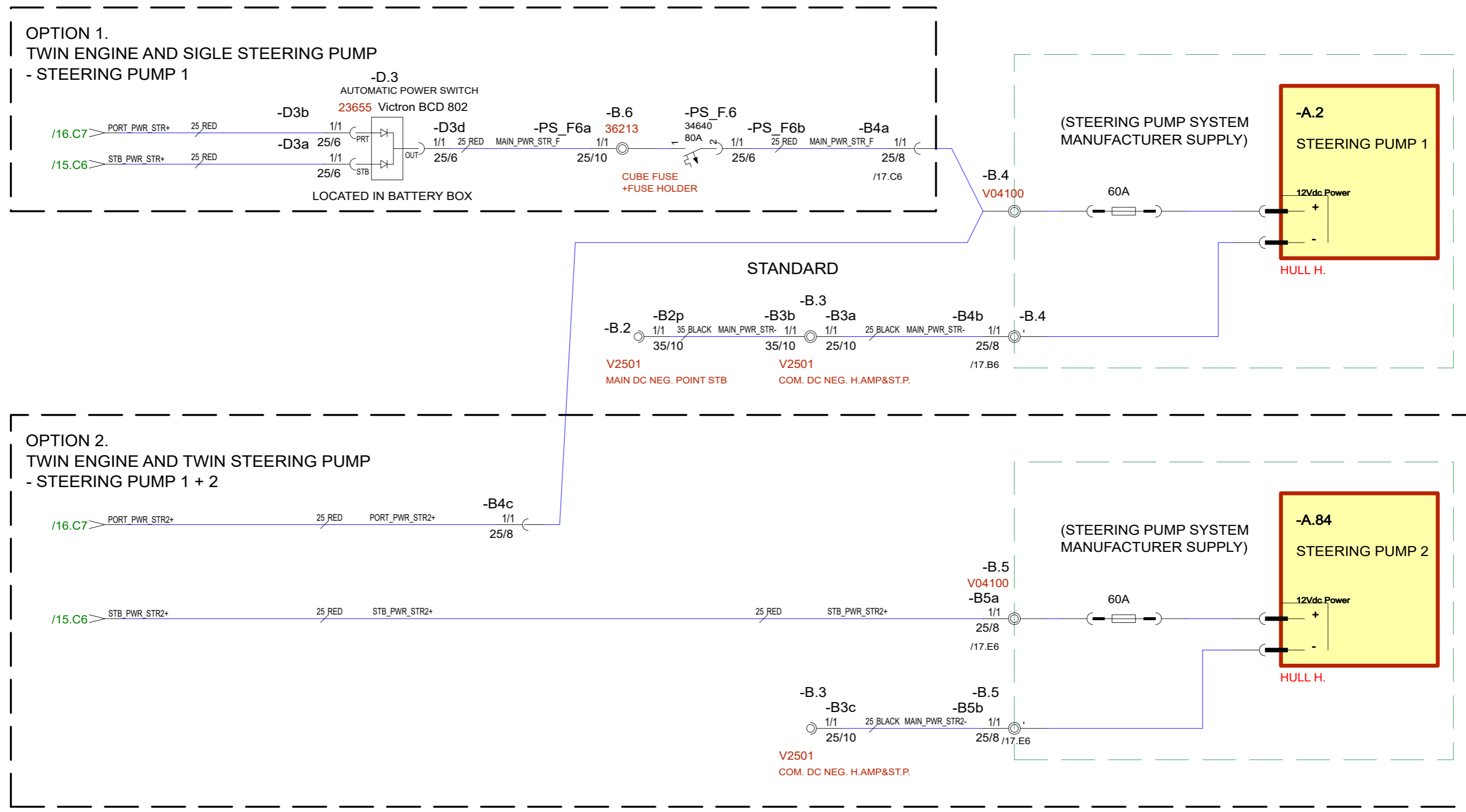

10.10.2023	PF	F22: 2004916; Not modified
20.2.2024	PF	G23; 2005054; Not modified
17.2.2023	RK	F21: NOT MODIFIED
Date of modification	Modified by	Description

Date	14.1.2019
Drawing by	TuM
Sheet rev.	23
Project rev.	G



Axopar
Boat
37 MY20
Boat model

Sub-product code	Product code	Project ID
POWER STEER - DIAGRAM		HL
Title	Loc	17 / 213
		Sheet

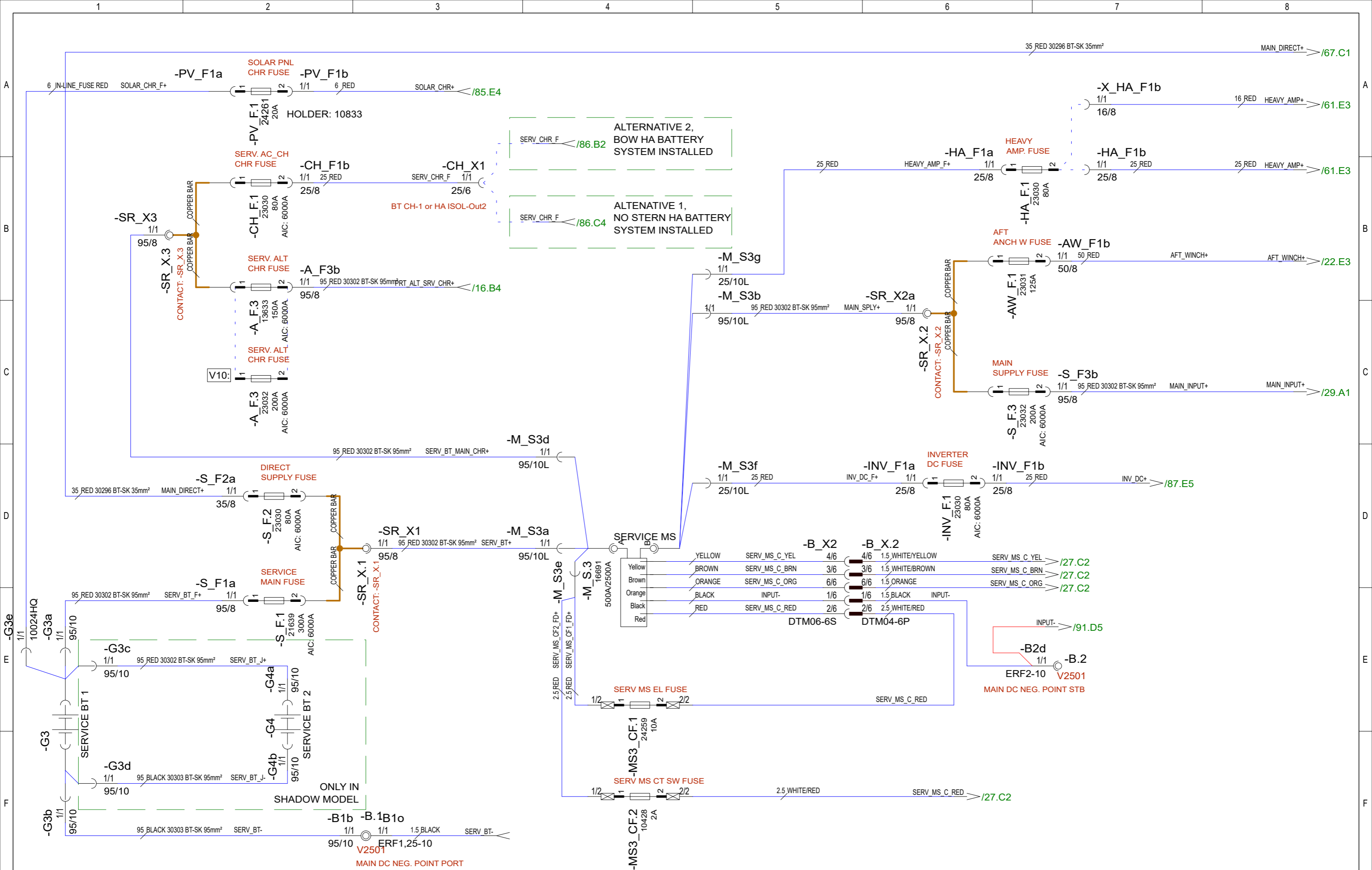

10.10.2023	PF	F22: 2004855; V10 update to cables and fusing	Date	14.1.2019		Axopar				
20.2.2024	PF	G23; 2005054; Not modified	Drawing by	TuM		Boat	37 MY20	Sub-product code	Product code	Project ID
17.2.2023	RK	F21: NOT MODIFIED	Sheet rev.	23		Boat model		SERVICE - DIAGRAM		HL
Date of modification	Modified by	Description	Project rev.	G	Copyright by		Title	Loc	18 / 213 Sheet	

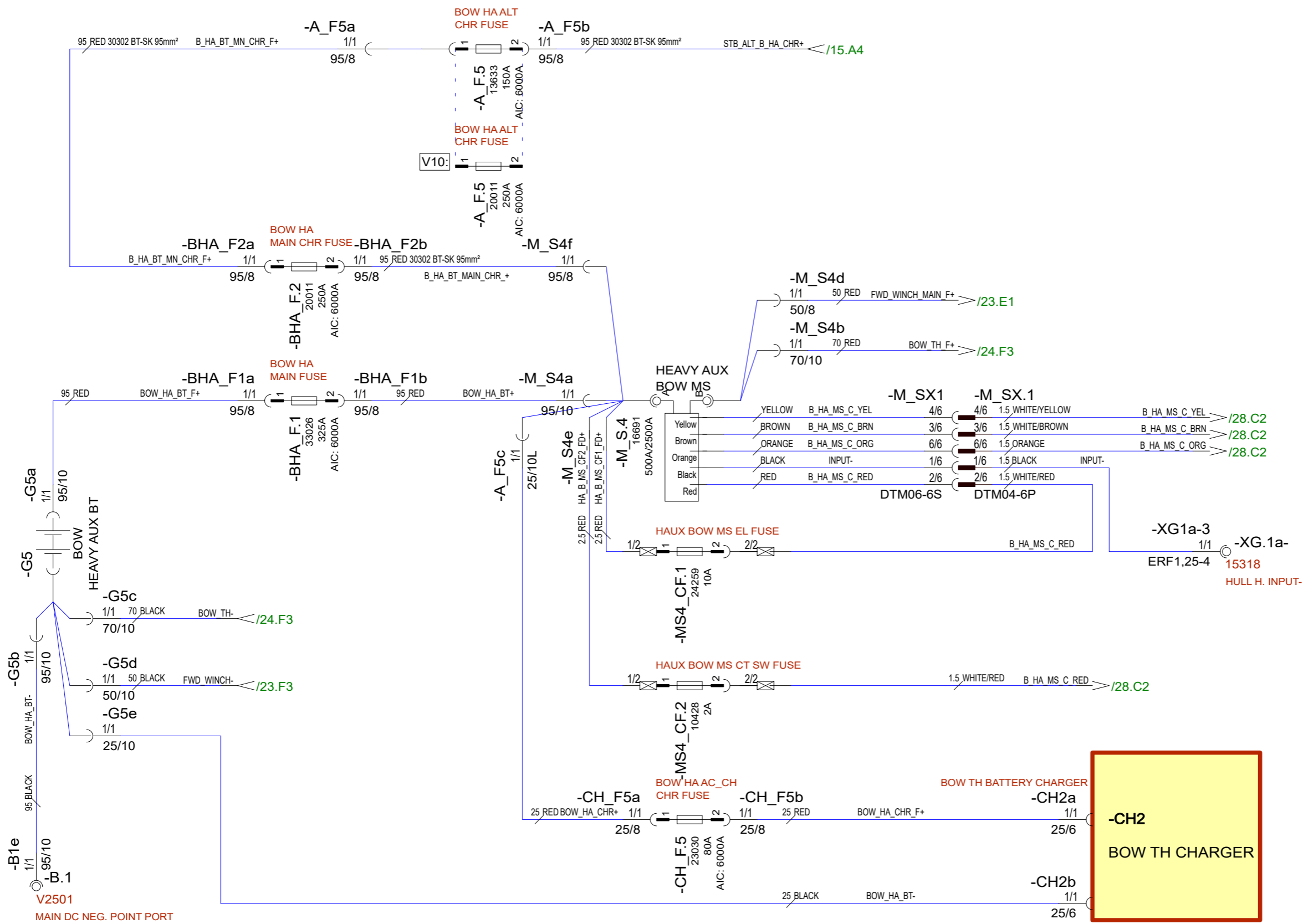

-CH2
 BOW TH CHARGER

10.10.2023	PF	F22: 2004855; V10 update to cables and fusing
20.2.2024	PF	G23; 2005054; Removed std chrgr, added cables for dedicated bow chrgr
17.2.2023	RK	F21: NOT MODIFIED
Date of modification	Modified by	Description

Date	14.1.2019
Drawing by	TuM
Sheet rev.	23
Project rev.	G



Axopar	Boat	Sub-product code	Product code	Project ID
	37 MY20	HEAVY AUX BOW		
Boat model		- DIAGRAM	HL	19 / 213
		Title	Loc	Sheet

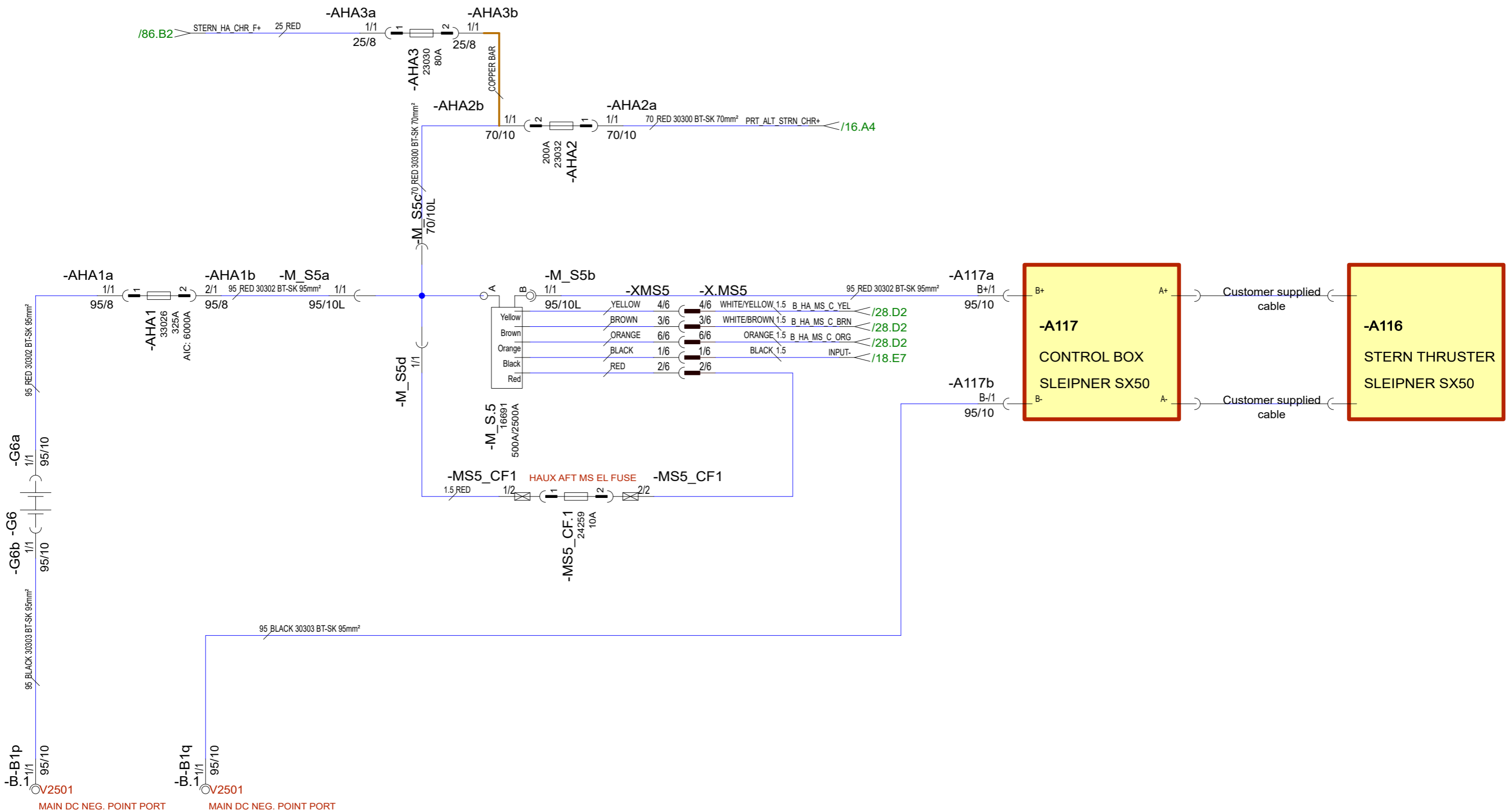

Date	20.2.2024
8.4.2024	PF
Sheet rev.	23
Date of modification	Modified by
	Description



Axopar			
Boat	37 MY20 SHADOW	Sub-product code	Product code
Boat model		STERN THRUSTER	Project ID
		- DIAGRAM	
		HL	91/ 213
		Loc	Sheet

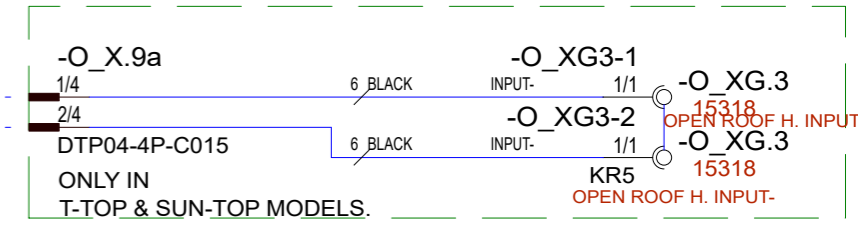
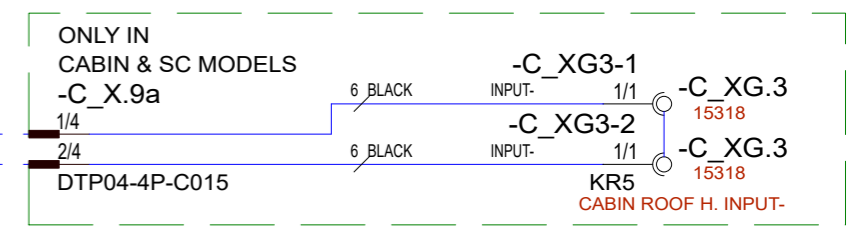
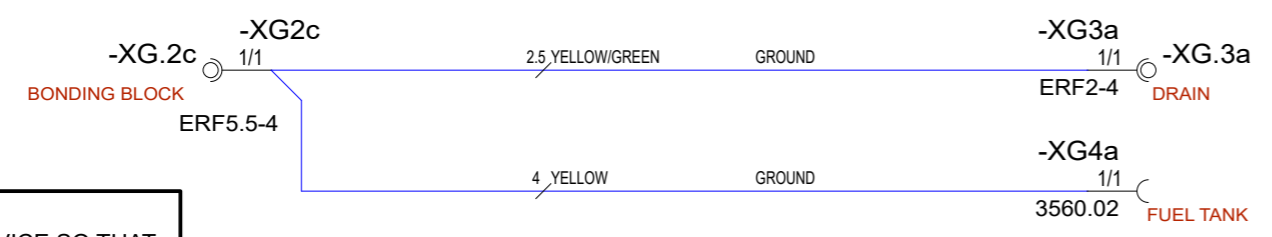
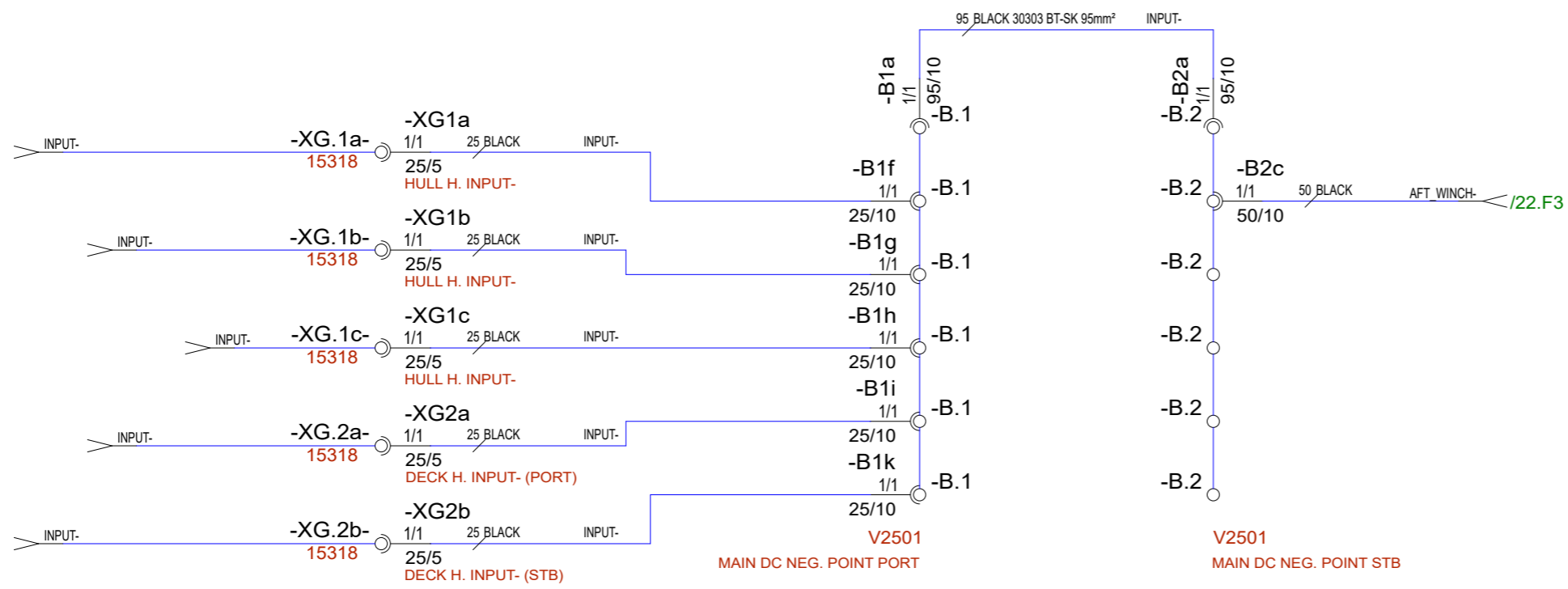

NOTICE!
INSTALL CABLES TO DEVICE SO THAT LARGEST TERMINALS ARE CLOSEST TO DEVICES CONDUCTIVE AREA.

EXAMPLE



10.10.2023	PF	F22: 2004916; Not modified	Date	14.1.2019
20.2.2024	PF	G23; 2005054; Not modified	Drawing by	TuM
17.2.2023	RK	F21: NOT MODIFIED	Sheet rev.	23
Date of modification	Modified by	Description	Project rev.	G

Axopar		Sub-product code		Product code		Project ID	
Boat		37 MY20		MAIN DC NEGATIVE POINT - DIAGRAM		HL	
Boat model		Title		Loc		20 / 213	
						Sheet	

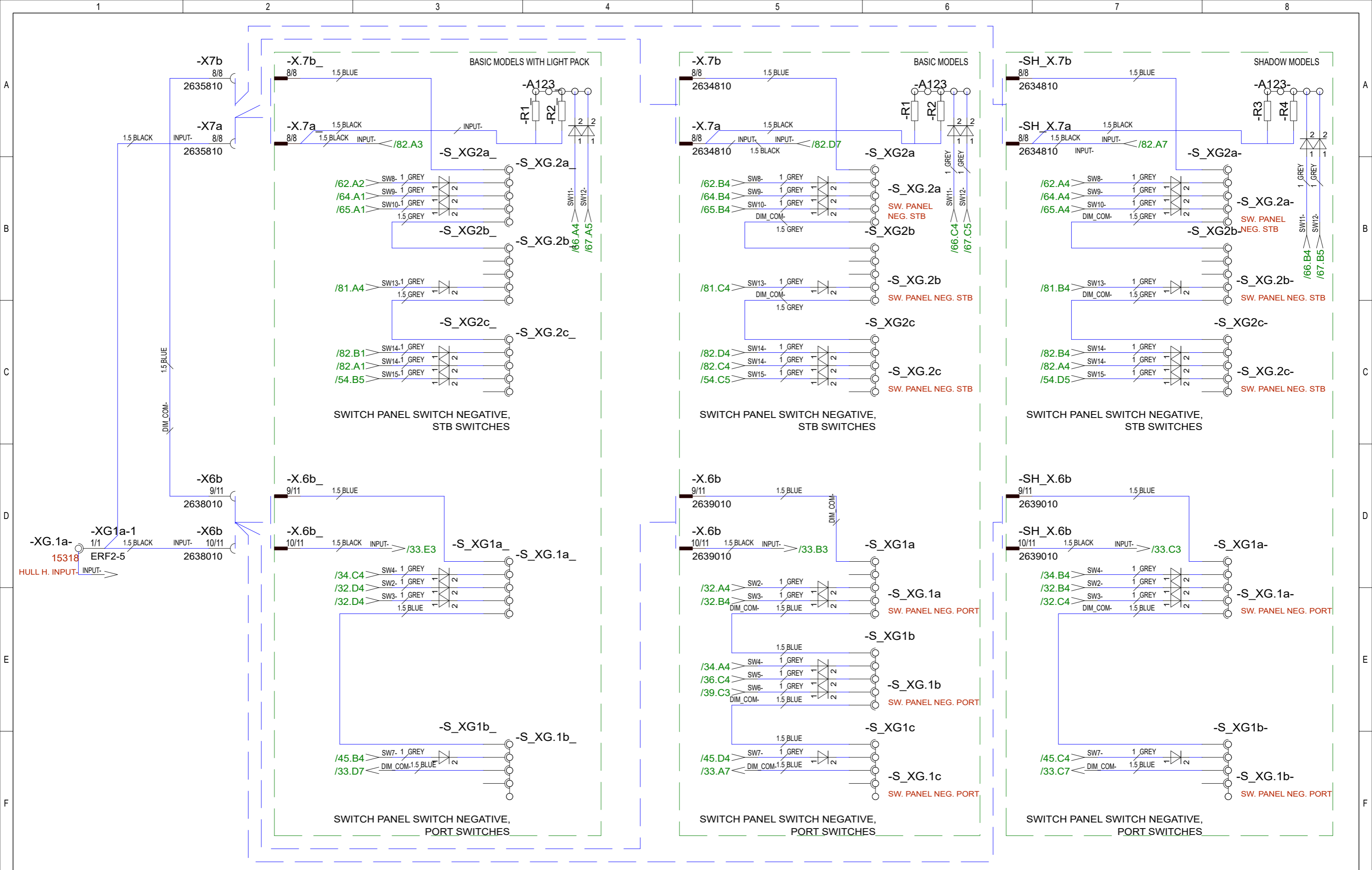

10.10.2023	PF	F22: 2004916; Added dimmer and diodes	Date	14.1.2019
20.2.2024	PF	G23; 2005054; LP version of swp added	Drawing by	TuM
17.2.2023	RK	F21: NOT MODIFIED	Sheet rev.	23
Date of modification	Modified by	Description	Project rev.	G



Axopar		Sub-product code		Product code		Project ID	
Boat		SWITCH PANEL INPUT-		HL		21/ 213	
37 MY20		- DIAGRAM		Loc		Sheet	
Boat model		Title					

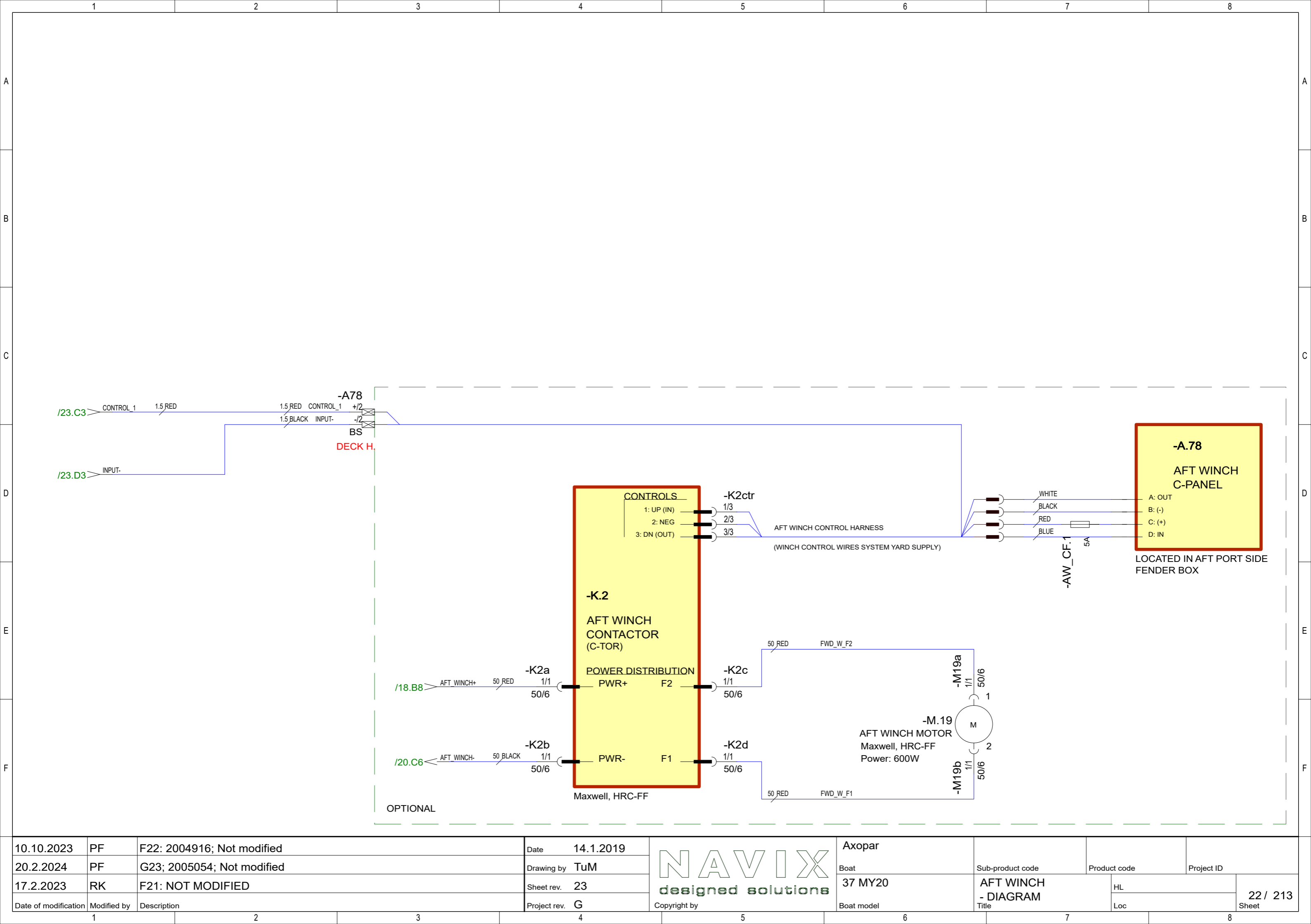

10.10.2023	PF	F22: 2004916; Not modified
20.2.2024	PF	G23; 2005054; Not modified
17.2.2023	RK	F21: NOT MODIFIED
Date of modification	Modified by	Description

Date	14.1.2019
Drawing by	TuM
Sheet rev.	23
Project rev.	G



Axopar
Boat
37 MY20
Boat model

Sub-product code	Product code	Project ID
AFT WINCH - DIAGRAM		HL
Title		Loc

22 / 213
Sheet

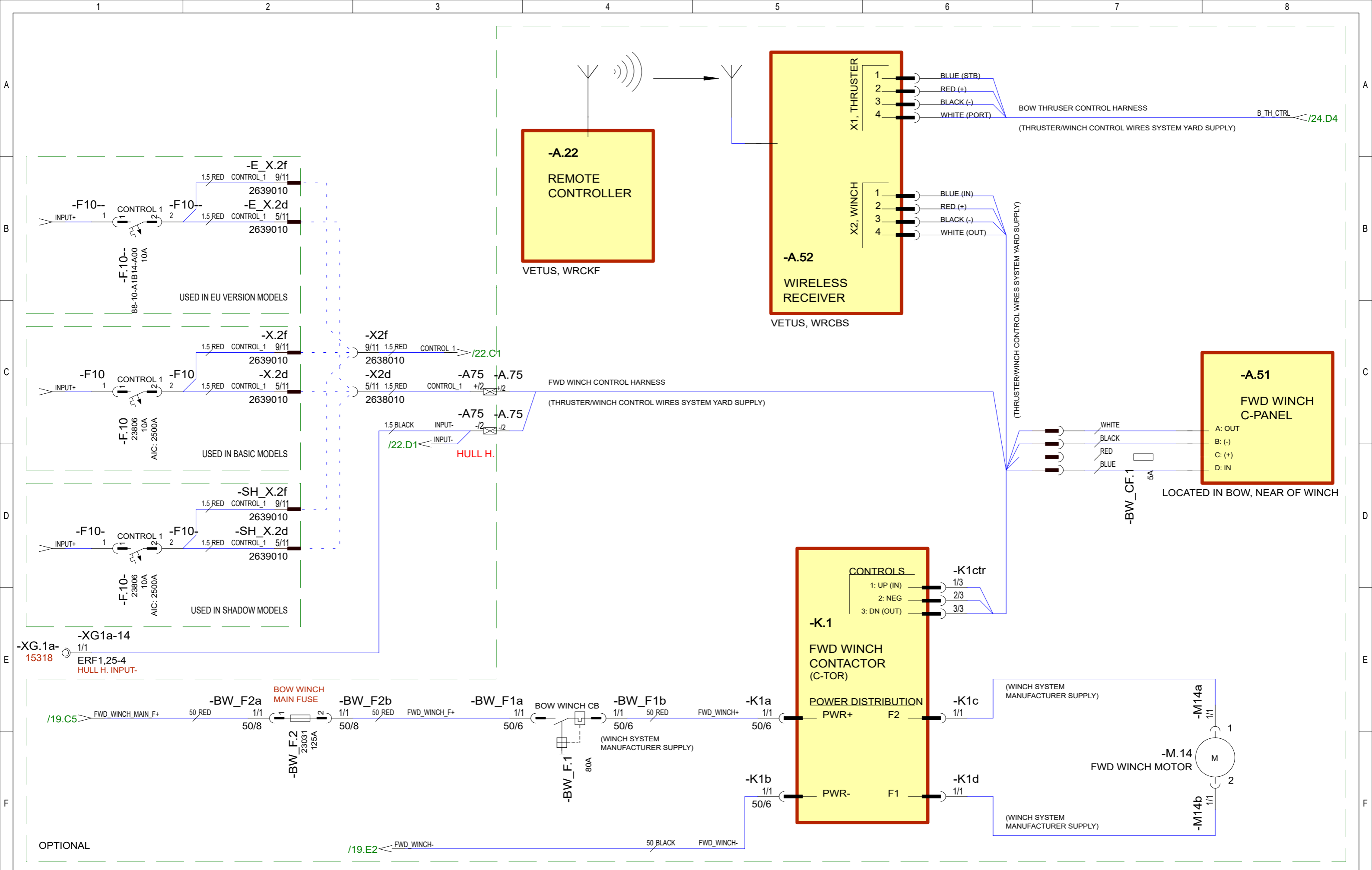

10.10.2023	PF	F22: 2004916; Winch fuse ->125A, cables ->50m2	Date	14.1.2019	NAVIX designed solutions	Axopar			
20.2.2024	PF	G23; 2005054; Not modified	Drawing by	TuM		Boat	37 MY20	Sub-product code	Product code
17.2.2023	RK	F21: NOT MODIFIED	Sheet rev.	23	Copyright by		FWD WINCH/ WIRELESS REMOTE - DIAGRAM		23 / 213
Date of modification	Modified by	Description	Project rev.	G		Boat model	Title	Loc	Sheet

BOW THRUSTER CONTROL ALTERNATIVES:

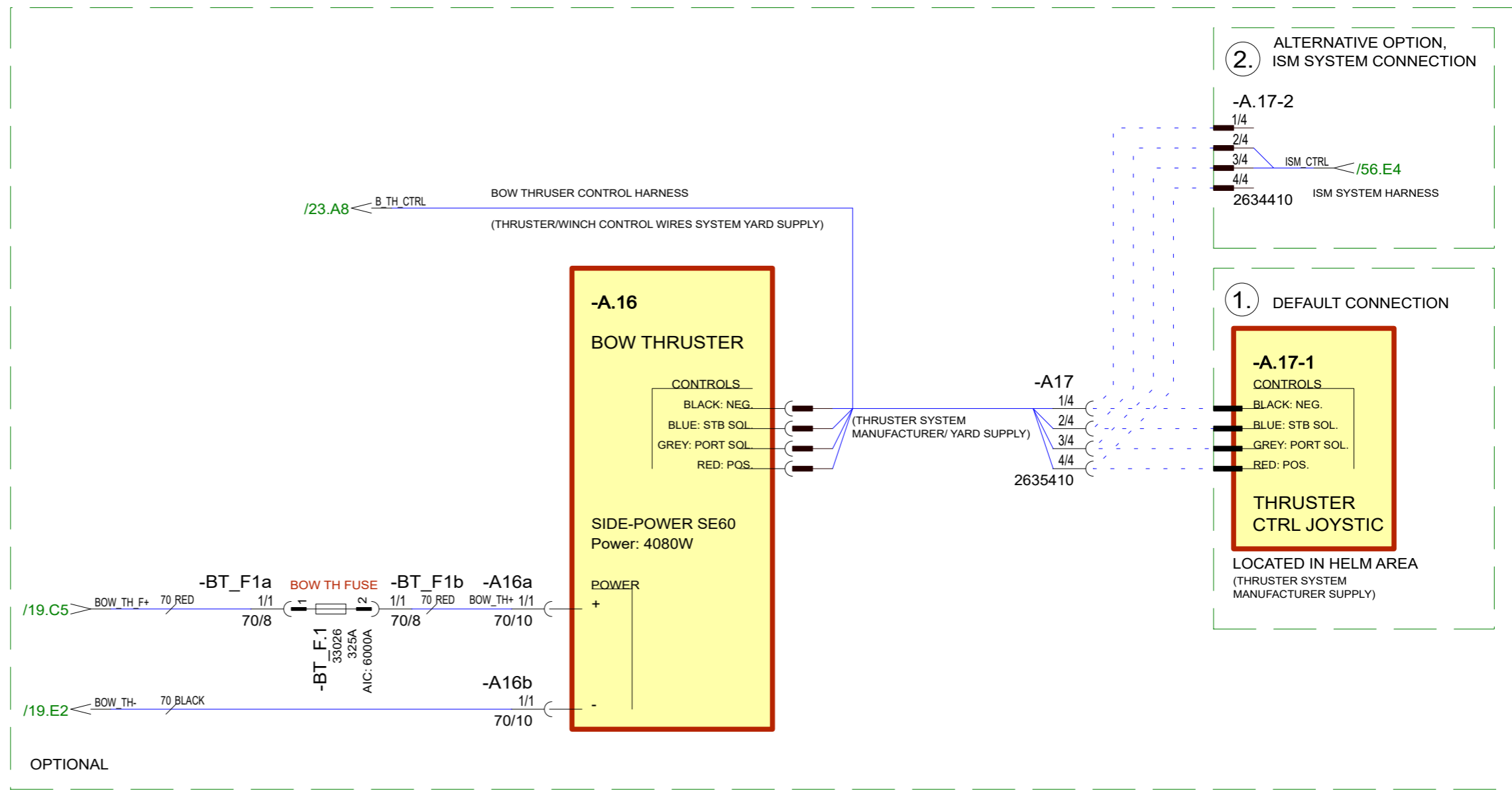
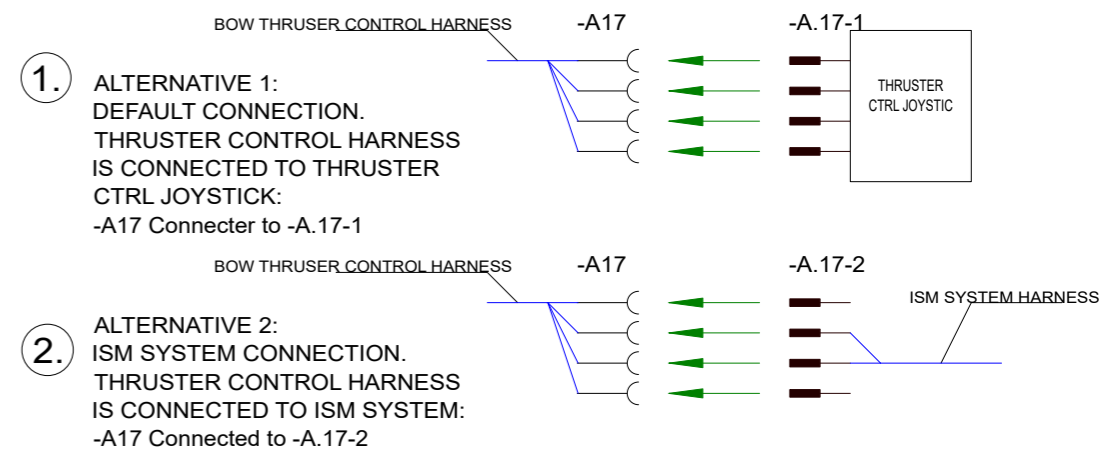

10.10.2023	PF	F22: 2004916; Not modified	Date	14.1.2019		Axopar			
20.2.2024	PF	G23; 2005054; Not modified	Drawing by	TuM		Boat	Sub-product code	Product code	Project ID
17.2.2023	RK	F21: NOT MODIFIED	Sheet rev.	23		37 MY20	BOW THRUSTER - DIAGRAM	HL	24 / 213
Date of modification	Modified by	Description	Project rev.	G		Boat model		Title	

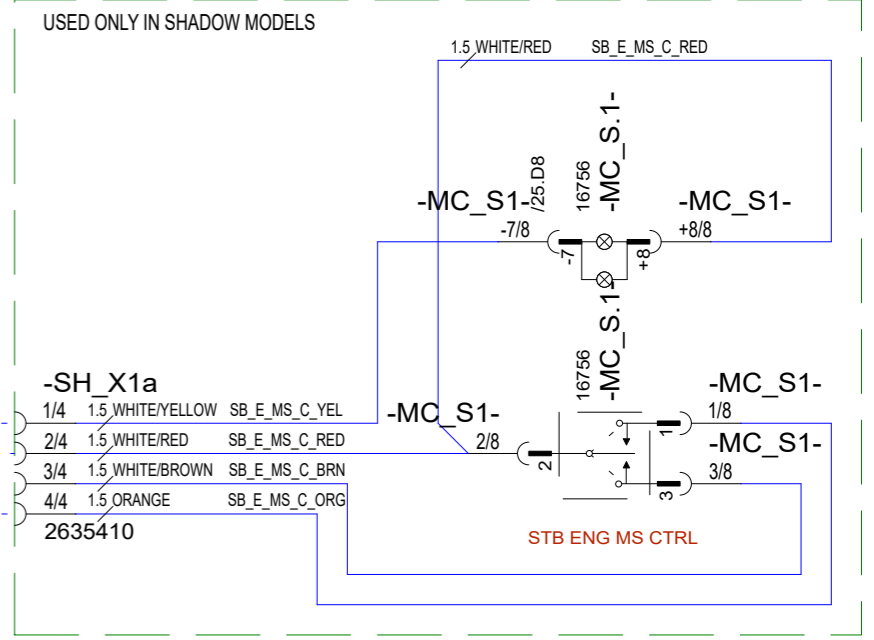
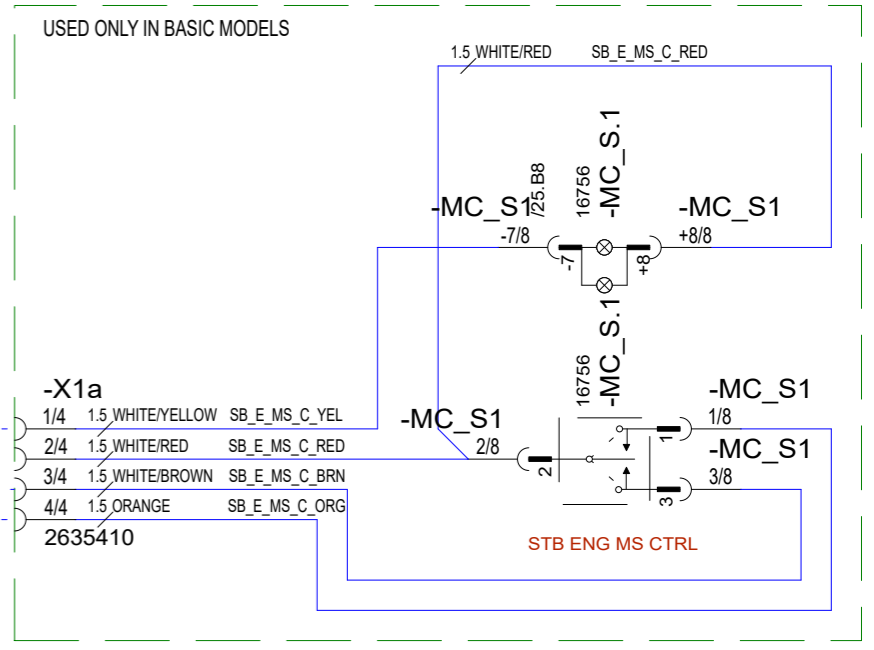
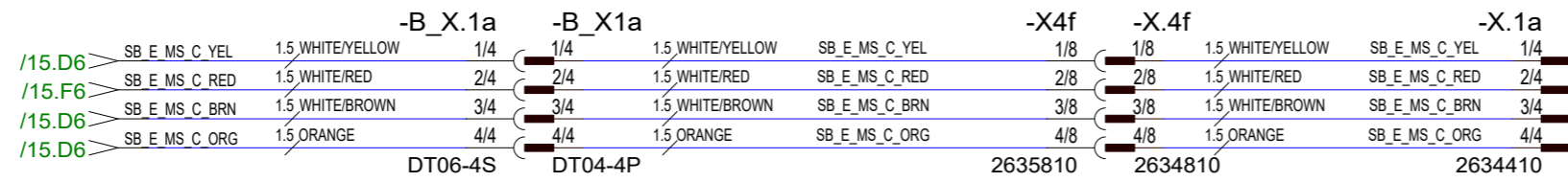

10.10.2023	PF	F22: 2004916; Not modified	Date	14.1.2019
20.2.2024	PF	G23; 2005054; Not modified	Drawing by	TuM
17.2.2023	RK	F21: NOT MODIFIED	Sheet rev.	23
Date of modification	Modified by	Description	Project rev.	G



Axopar			
Boat	37 MY20	Sub-product code	Product code
Boat model		MAIN SWITCH CTRL SW	HL
		START STB - DIAGRAM	Loc
			25 / 213
			Sheet

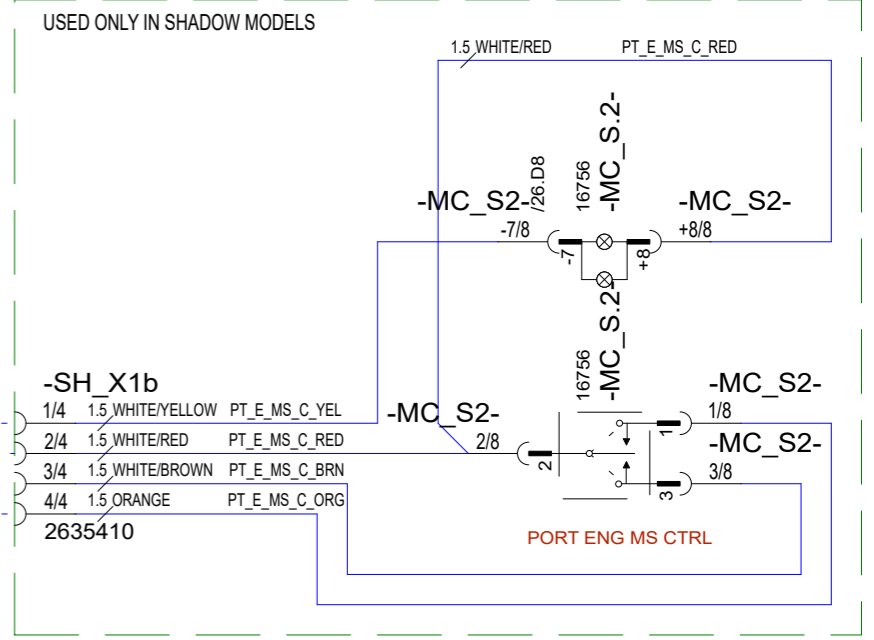
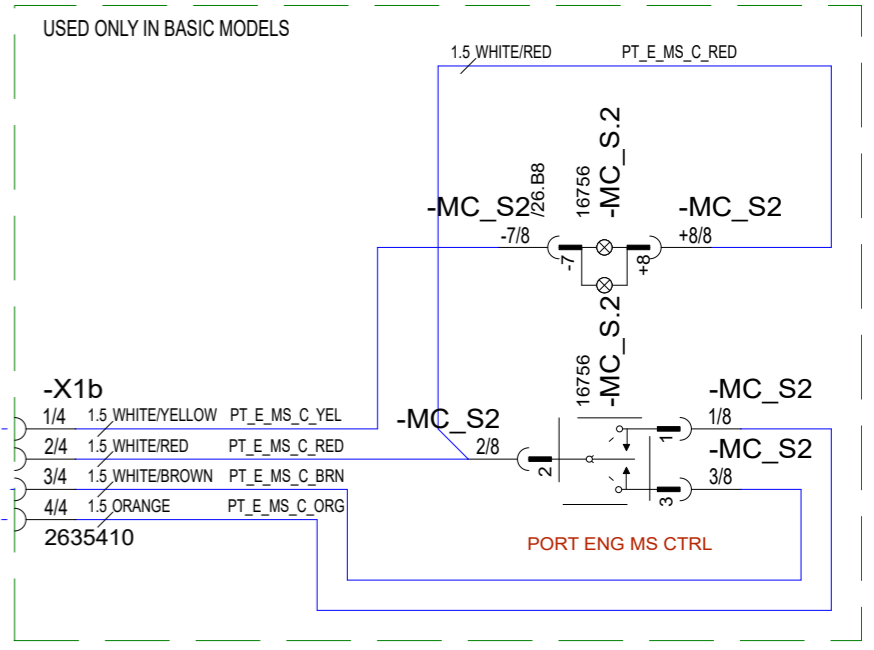
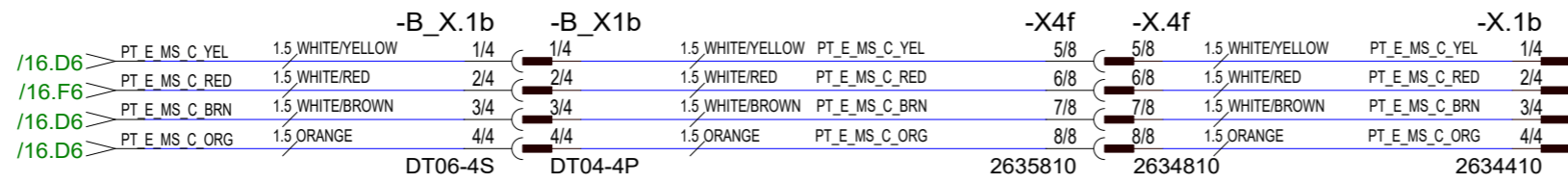

10.10.2023	PF	F22: 2004916; Not modified	Date	16.4.2020
20.2.2024	PF	G23; 2005054; Not modified	Drawing by	TuM
17.2.2023	RK	F21: NOT MODIFIED	Sheet rev.	23
Date of modification	Modified by	Description	Project rev.	G



Axopar			
Boat	37 MY20	Sub-product code	Product code
Boat model		MAIN SWITCH CTRL SW START PORT - DIAGRAM	Project ID
		HL	26 / 213
		Loc	Sheet

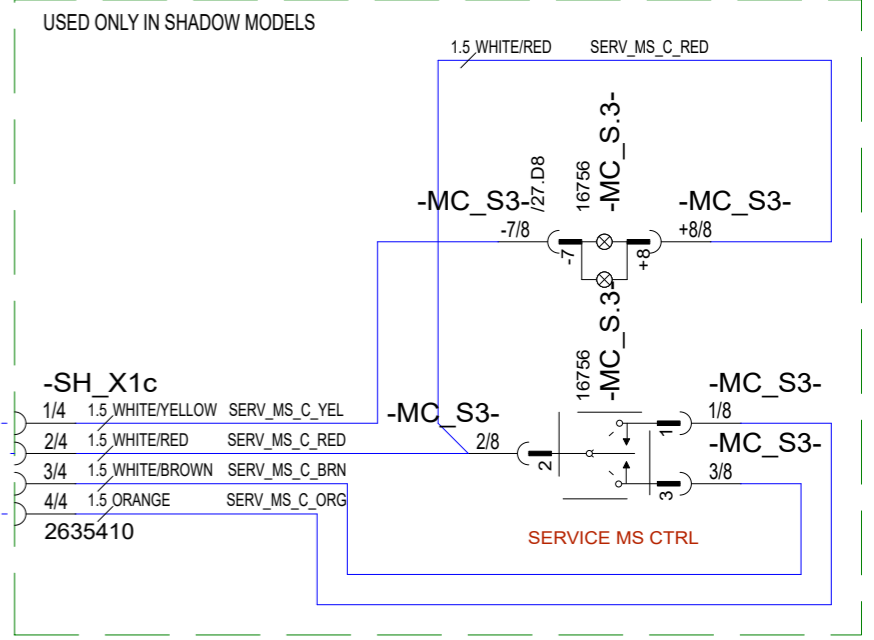
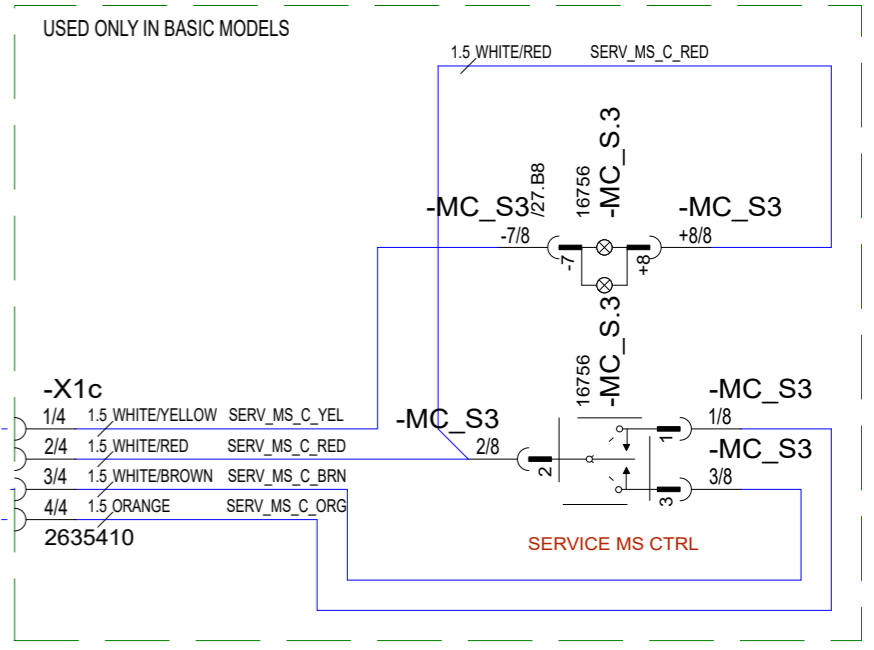
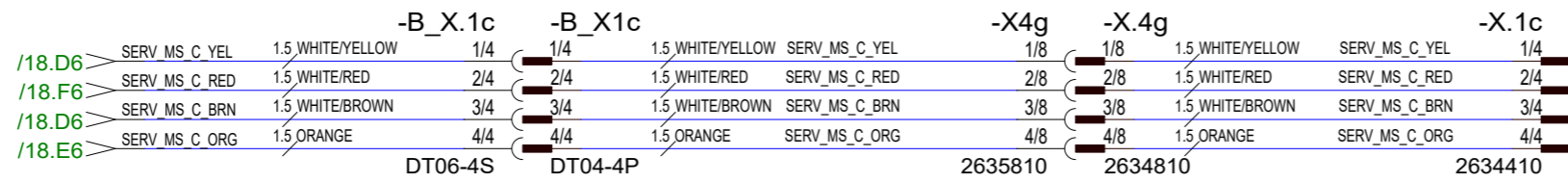

10.10.2023	PF	F22: 2004916; Not modified	Date	14.5.2019
20.2.2024	PF	G23; 2005054; Not modified	Drawing by	TuM
17.2.2023	RK	F21: NOT MODIFIED	Sheet rev.	23
Date of modification	Modified by	Description	Project rev.	G



Axopar			
Boat	37 MY20	Sub-product code	Product code
Boat model		MAIN SWITCH CTRL SW	Project ID
		SERVICE - DIAGRAM	HL
			Loc
			27 / 213
			Sheet

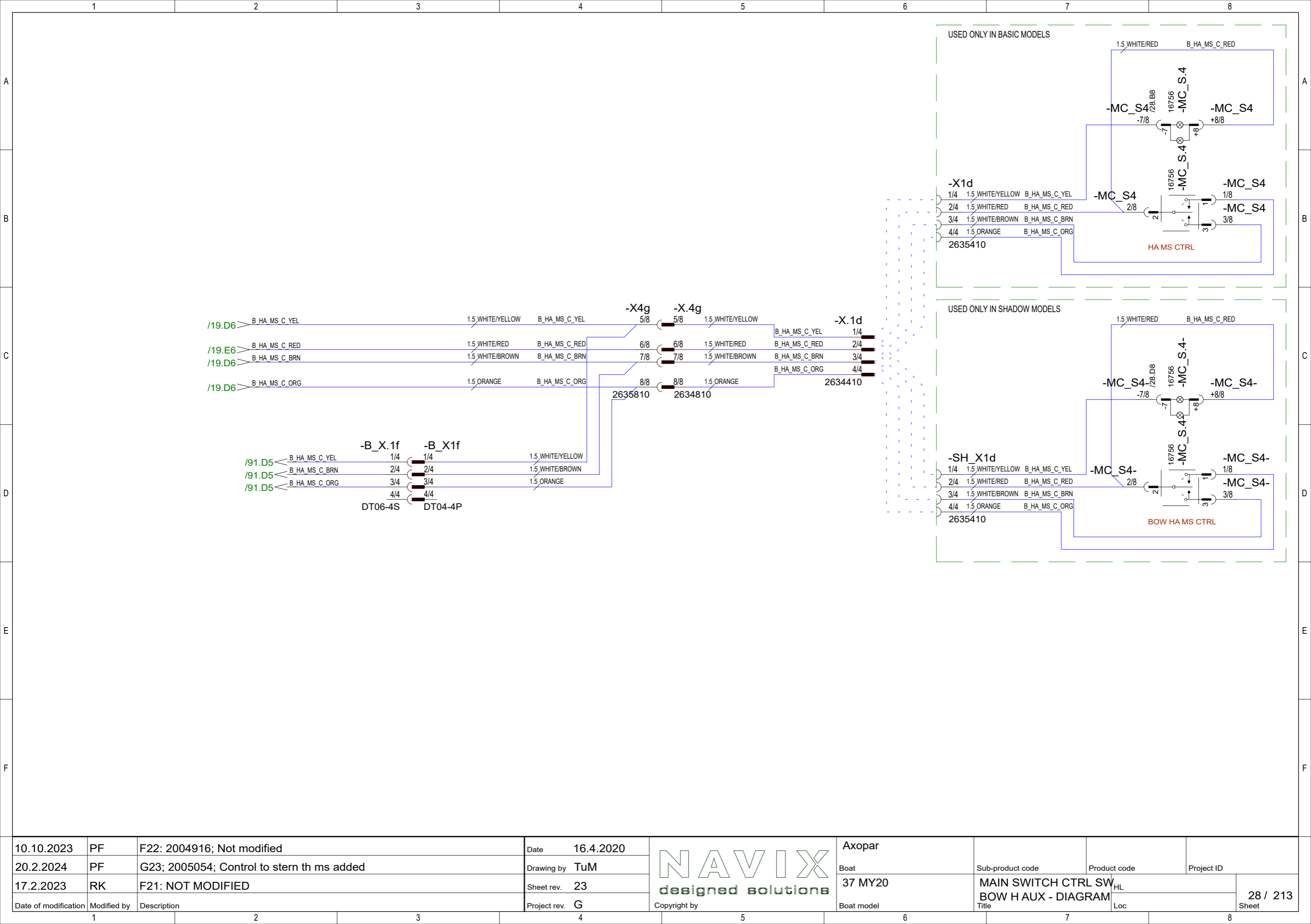

10.10.2023	PF	F22: 2004916; Not modified	Date	16.4.2020
20.2.2024	PF	G23; 2005054; Control to stern th ms added	Drawing by	TuM
17.2.2023	RK	F21: NOT MODIFIED	Sheet rev.	23
Date of modification	Modified by	Description	Project rev.	G



Axopar			
Boat	37 MY20	Sub-product code	Product code
Boat model		MAIN SWITCH CTRL SW _{HL}	
		BOW H AUX - DIAGRAM	
		Loc	28 / 213
			Sheet

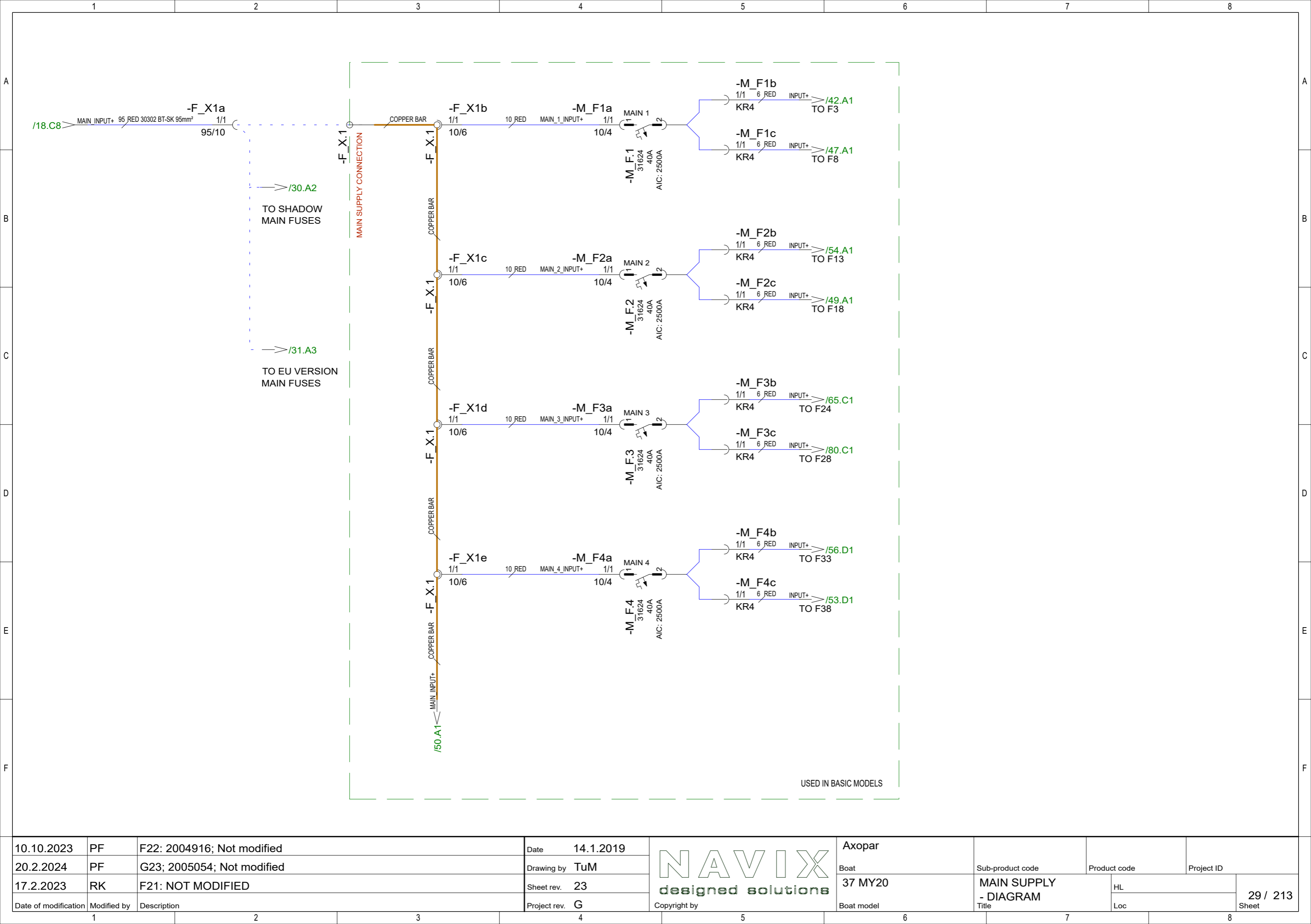

10.10.2023	PF	F22: 2004916; Not modified
20.2.2024	PF	G23; 2005054; Not modified
17.2.2023	RK	F21: NOT MODIFIED
Date of modification	Modified by	Description

Date	14.1.2019
Drawing by	TuM
Sheet rev.	23
Project rev.	G



Axopar
Boat
37 MY20
Boat model

Sub-product code	Product code	Project ID
MAIN SUPPLY - DIAGRAM		HL
Title	Loc	29 / 213
		Sheet

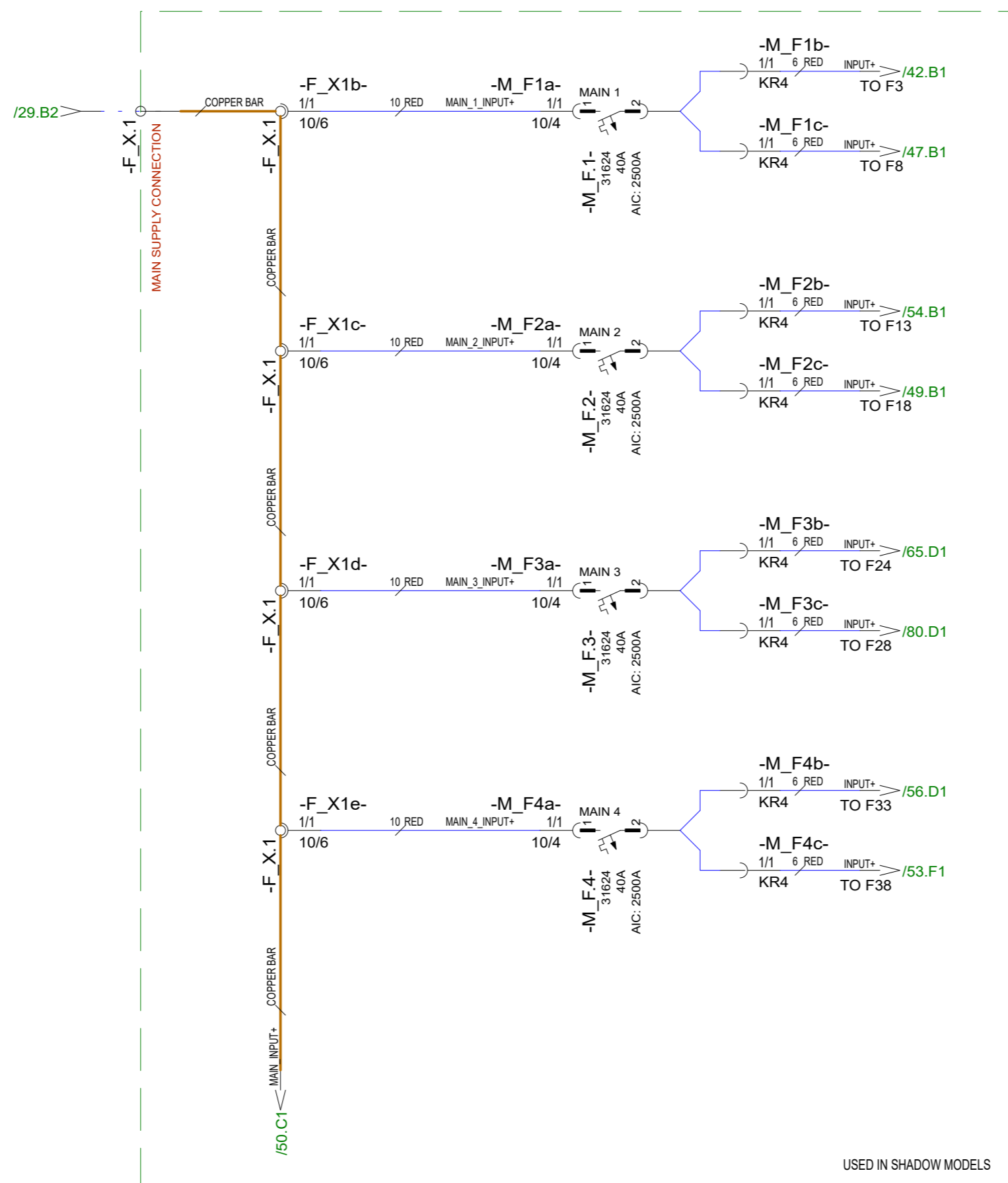

10.10.2023	PF	F22: 2004916; Not modified	Date	23.4.2020	 Copyright by	Axopar			
20.2.2024	PF	G23; 2005054; Not modified	Drawing by	TuM		Boat	Sub-product code	Product code	Project ID
17.2.2023	RK	F21: NOT MODIFIED	Sheet rev.	23		37 MY20	MAIN SUPPLY - DIAGRAM Title	HL	30 / 213 Sheet
Date of modification	Modified by	Description	Project rev.	G		Boat model		Loc	

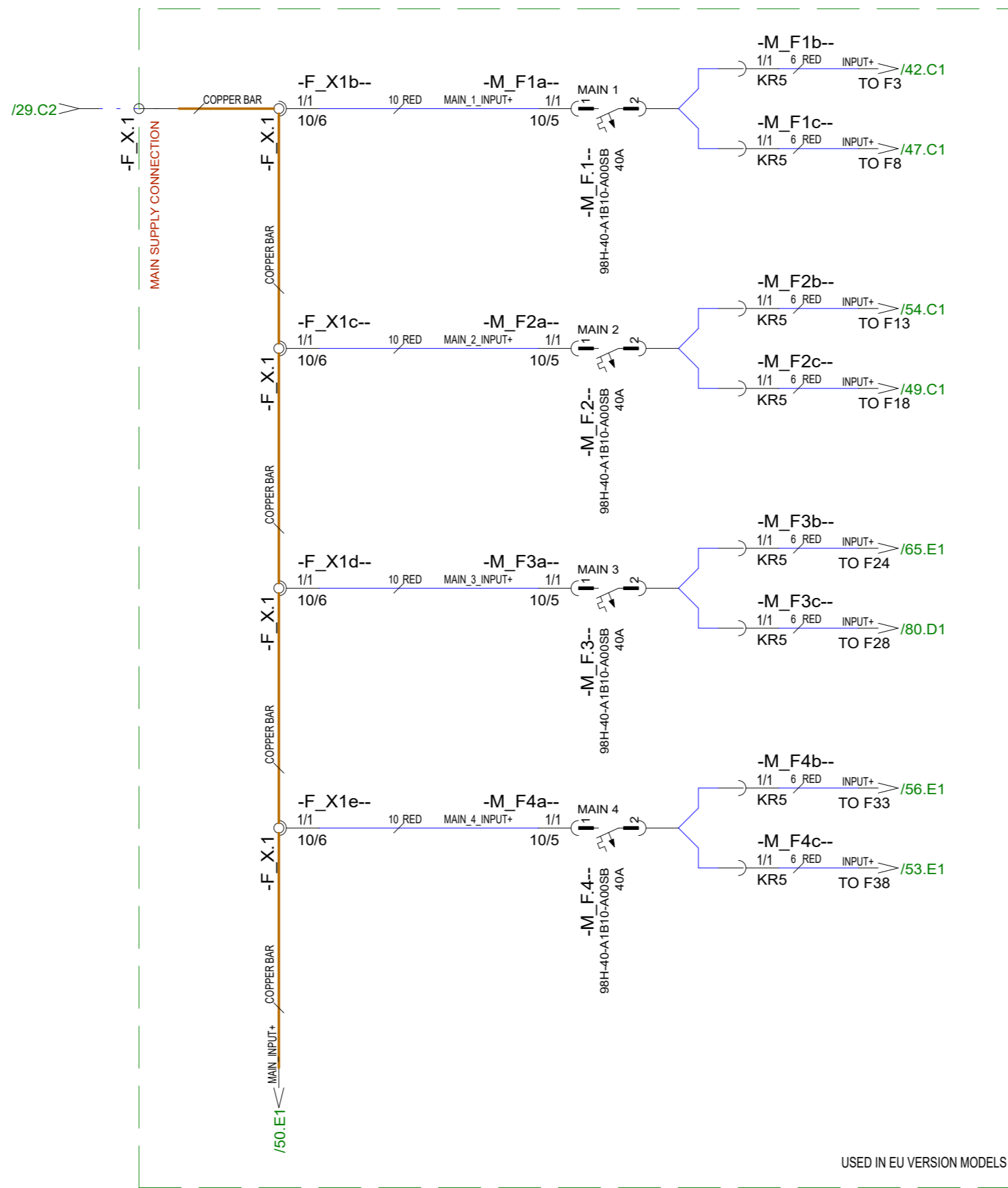

USED IN EU VERSION MODELS

10.10.2023	PF	F22: 2004916; Not modified	Date	23.04.2020		Axopar			
20.2.2024	PF	G23; 2005054; Not modified	Drawing by	TuM		Boat	Sub-product code	Product code	Project ID
17.2.2023	RK	F21: NOT MODIFIED	Sheet rev.	23		37 MY20	MAIN SUPPLY - DIAGRAM	HL	31/ 213 Sheet
Date of modification	Modified by	Description	Project rev.	G		Boat model		Title	

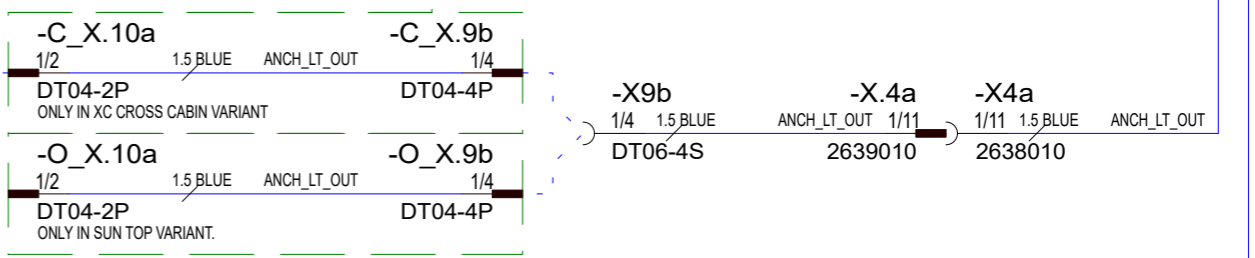
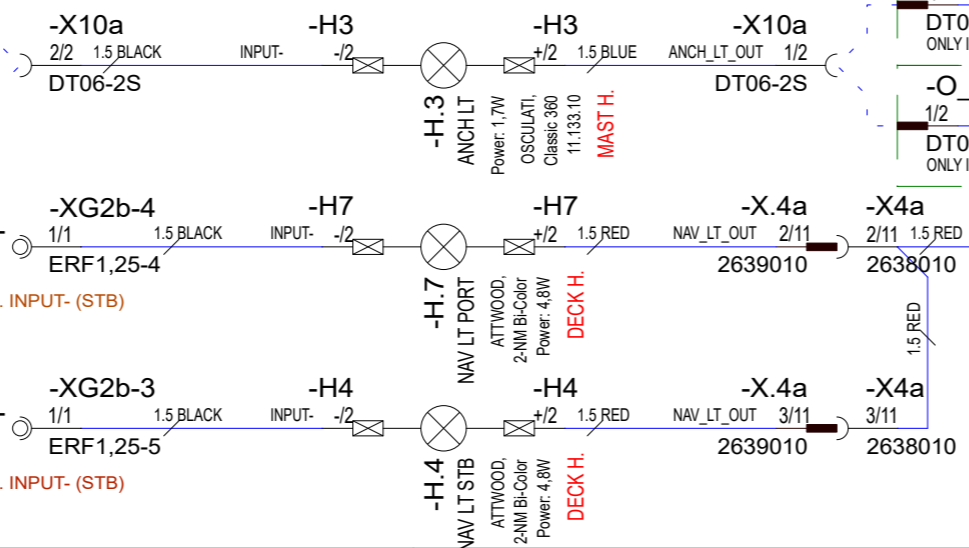
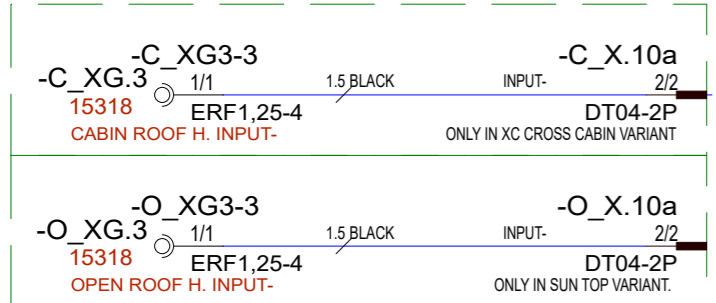
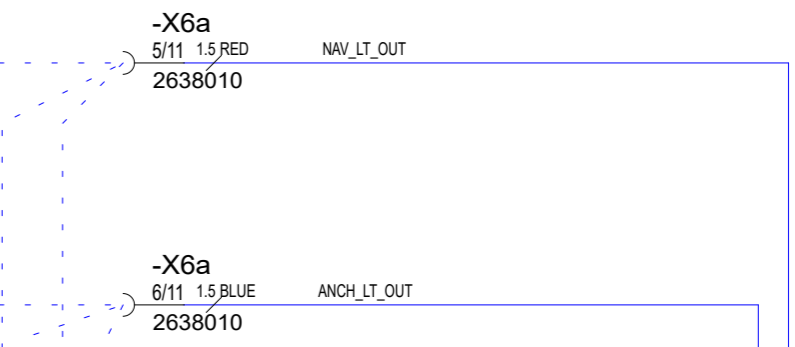
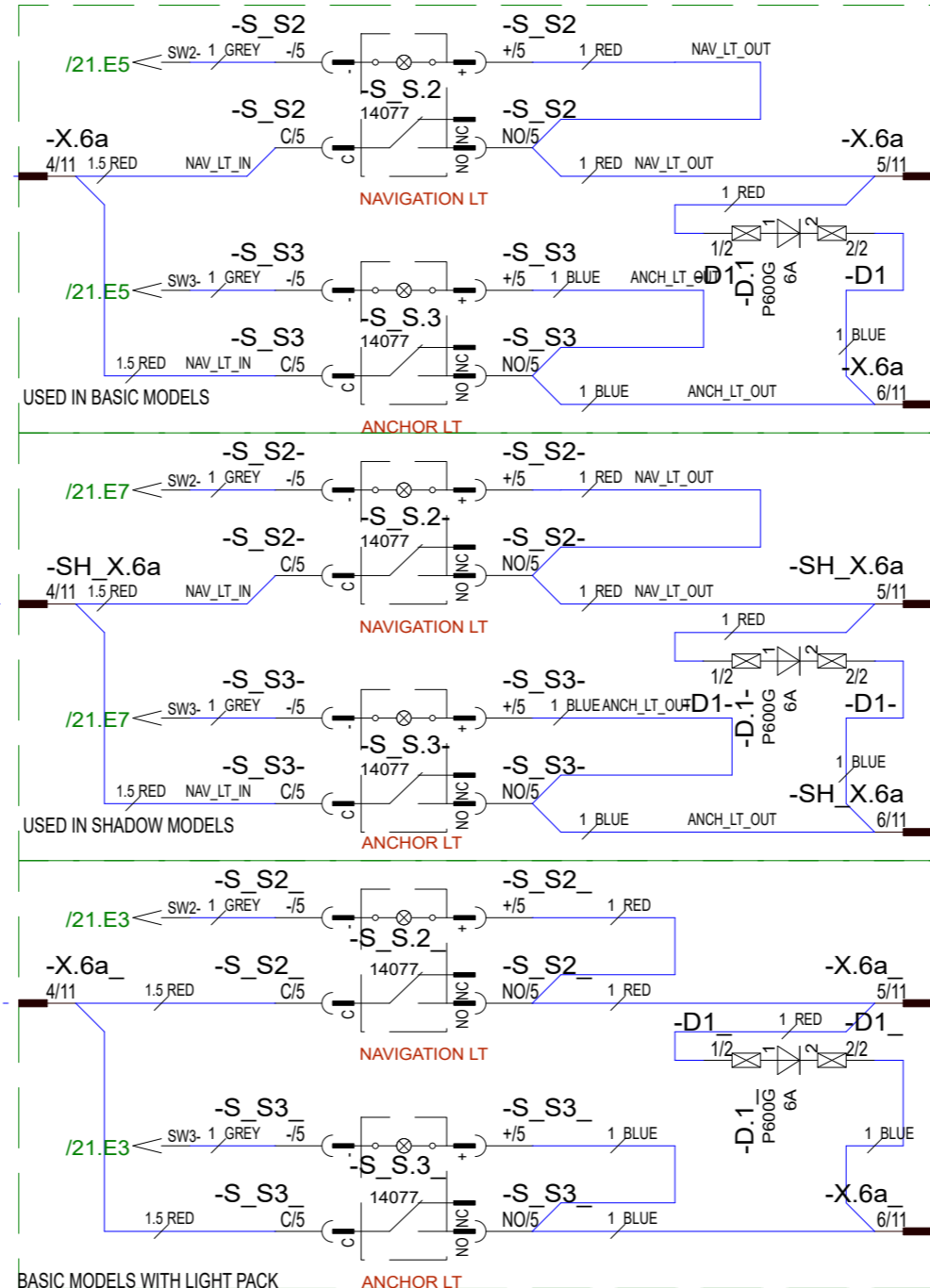
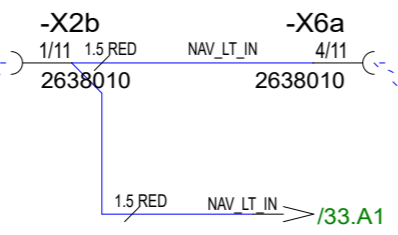
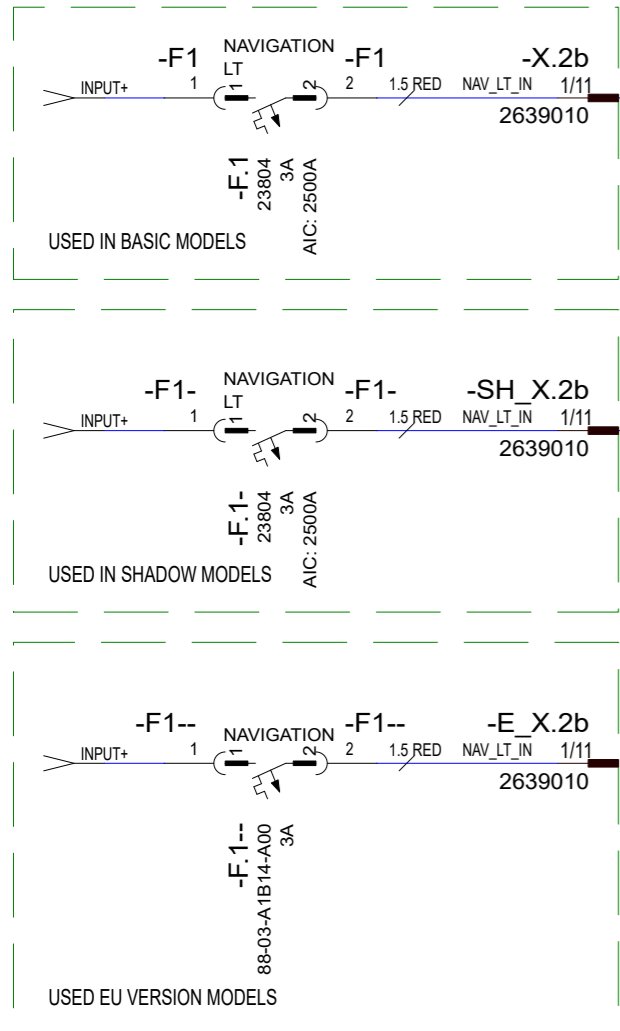

10.10.2023	PF	F22: 2004916; Not modified	Date	14.1.2019		Axopar					
20.2.2024	PF	G23; 2005054; Light pack version added	Drawing by	TuM		Boat	37 MY20	Sub-product code	NAVIGATION LIGHTS	Product code	Project ID
17.2.2023	RK	F21: H5 REMOVED	Sheet rev.	23		Boat model	37 MY20	NAVIGATION LIGHTS	- DIAGRAM	HL	32 / 213
Date of modification	Modified by	Description	Project rev.	G	Copyright by				Loc	Sheet	

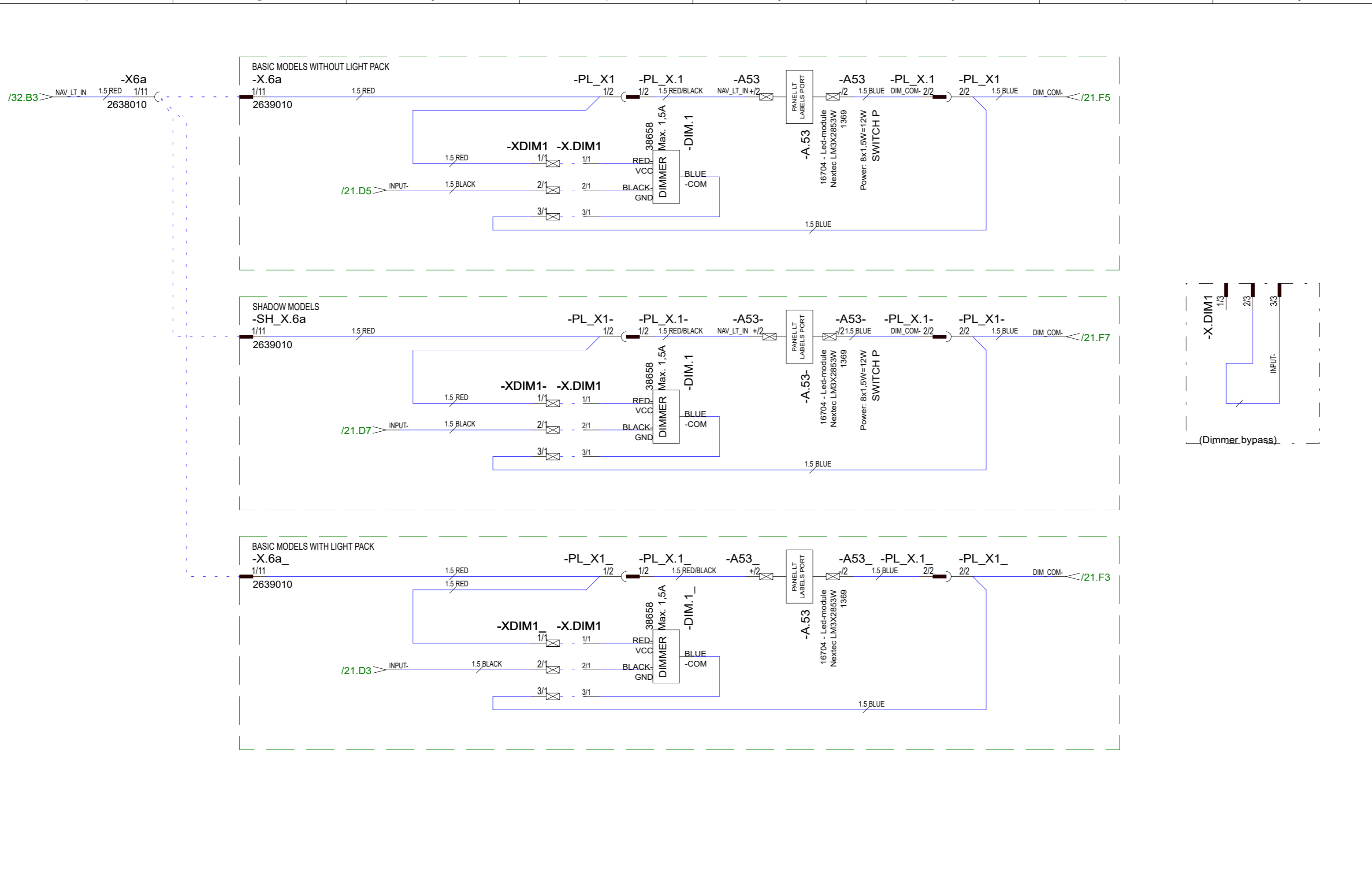

10.10.2023	PF	F22: 2004916; Not modified	Date	14.1.2019
20.2.2024	PF	G23; 2005054; Logo It supply ->deck It, panel It switch repl. with dimmer	Drawing by	TuM
17.2.2023	RK	F21: NOT MODIFIED	Sheet rev.	23
Date of modification	Modified by	Description	Project rev.	G



Axopar					
Boat	37 MY20	Sub-product code	Product code	Project ID	
Boat model		PANEL LIGHTS - DIAGRAM		HL	33 / 213
		Title		Loc	

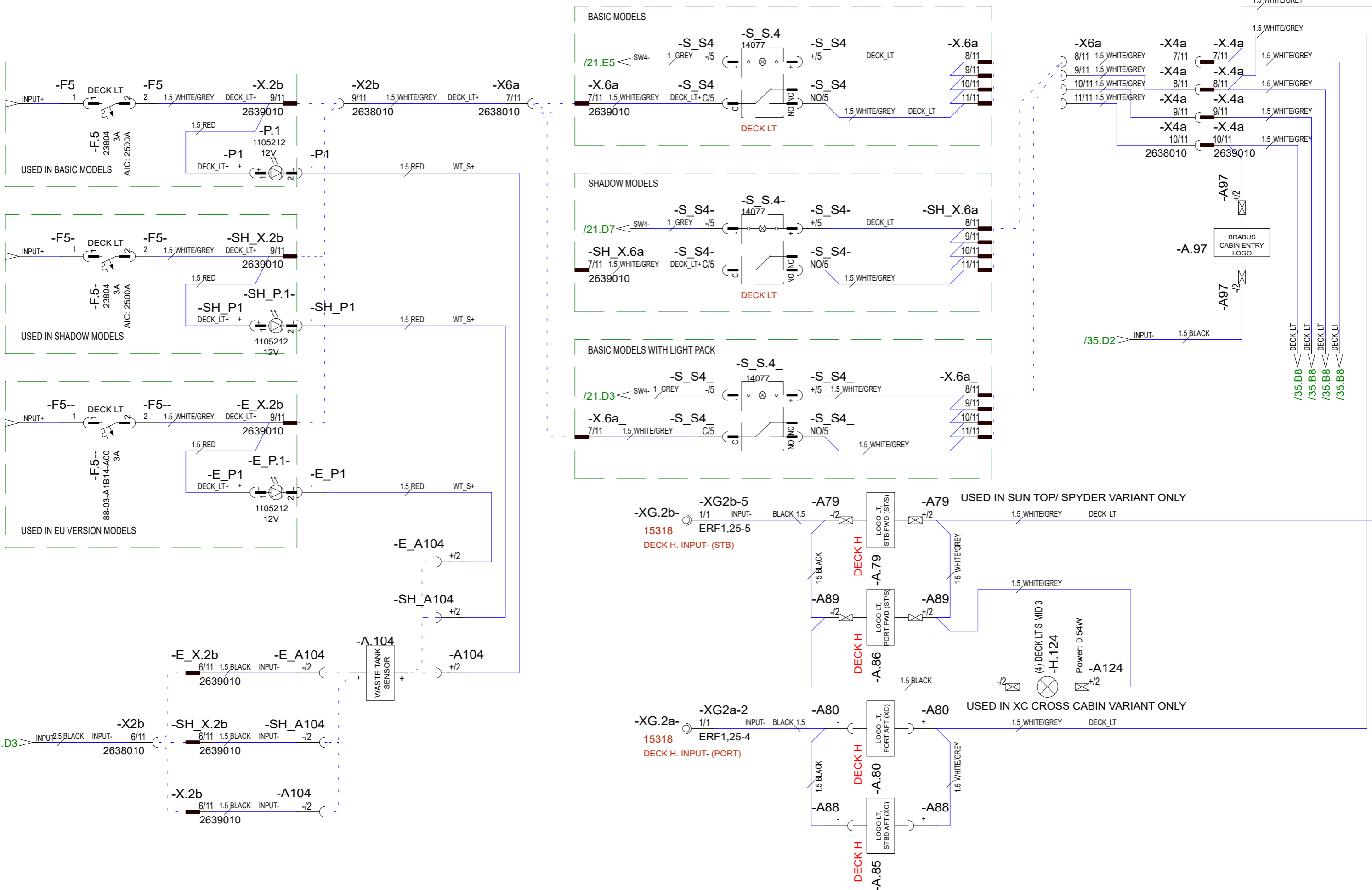

10.10.2023	PF	F22: 2004916; Not modified	Date	14.1.2019
20.2.2024	PF	G23; 2005054; Logo lts moved to deck lts	Drawing by	TuM
17.2.2023	RK	F21: NOT MODIFIED	Sheet rev.	23
Date of modification	Modified by	Description	Project rev.	G



Axopar	Boat	37 MY20	Sub-product code	Product code	Project ID
			DECK LIGHT, LOGO LIGHT - DIAGRAM	HL	34 / 213
			Title	Loc	Sheet

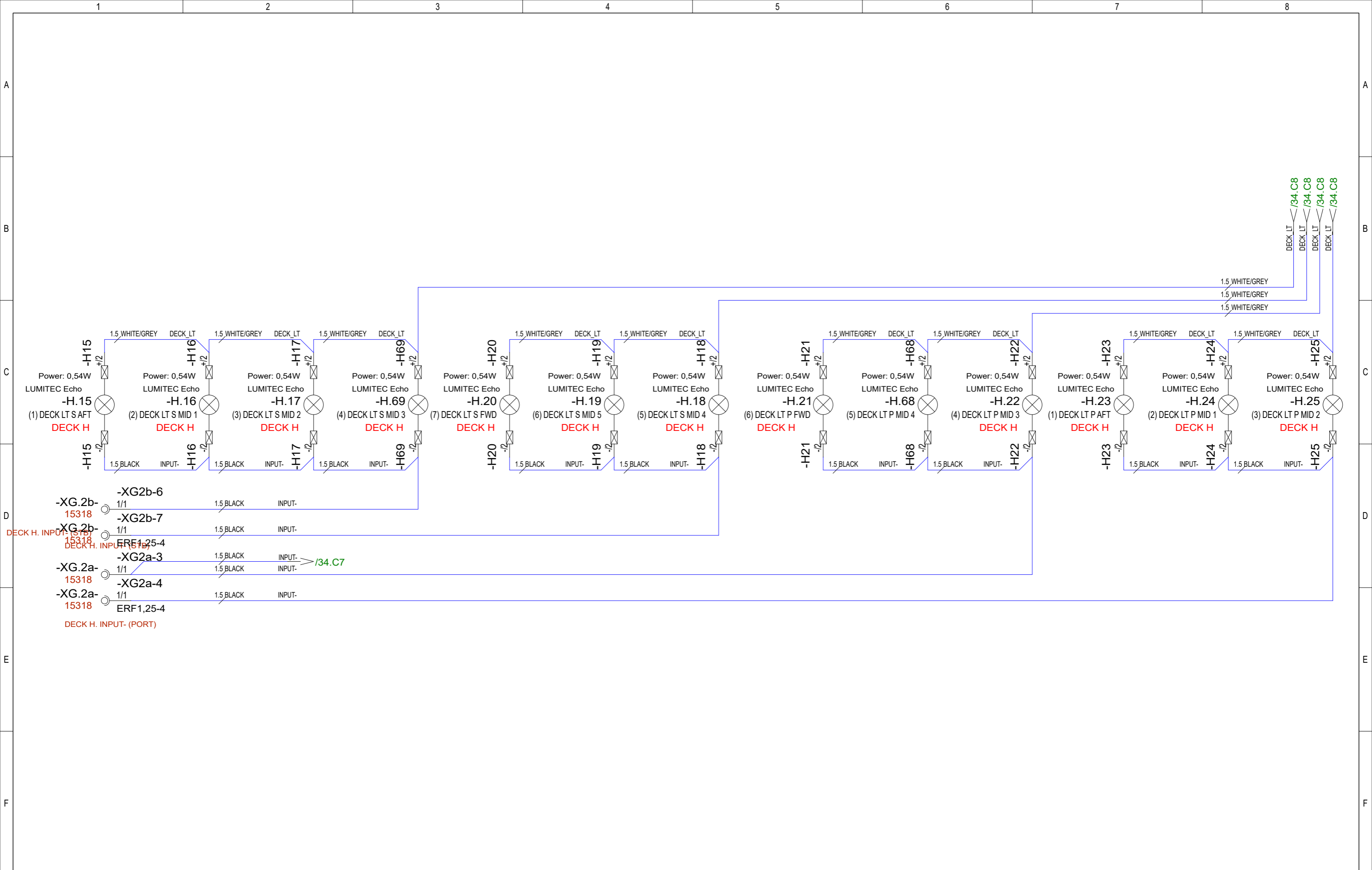

10.10.2023	PF	F22: 2004916; Not modified	Date	14.1.2019
20.2.2024	PF	G23; 2005054; Not modified	Drawing by	TuM
17.2.2023	RK	F21: NOT MODIFIED	Sheet rev.	23
Date of modification	Modified by	Description	Project rev.	G



Axopar			
Boat	37 MY20	Sub-product code	Product code
Boat model		DECK LIGHT - DIAGRAM	Project ID
		HL	35 / 213
		Loc	Sheet

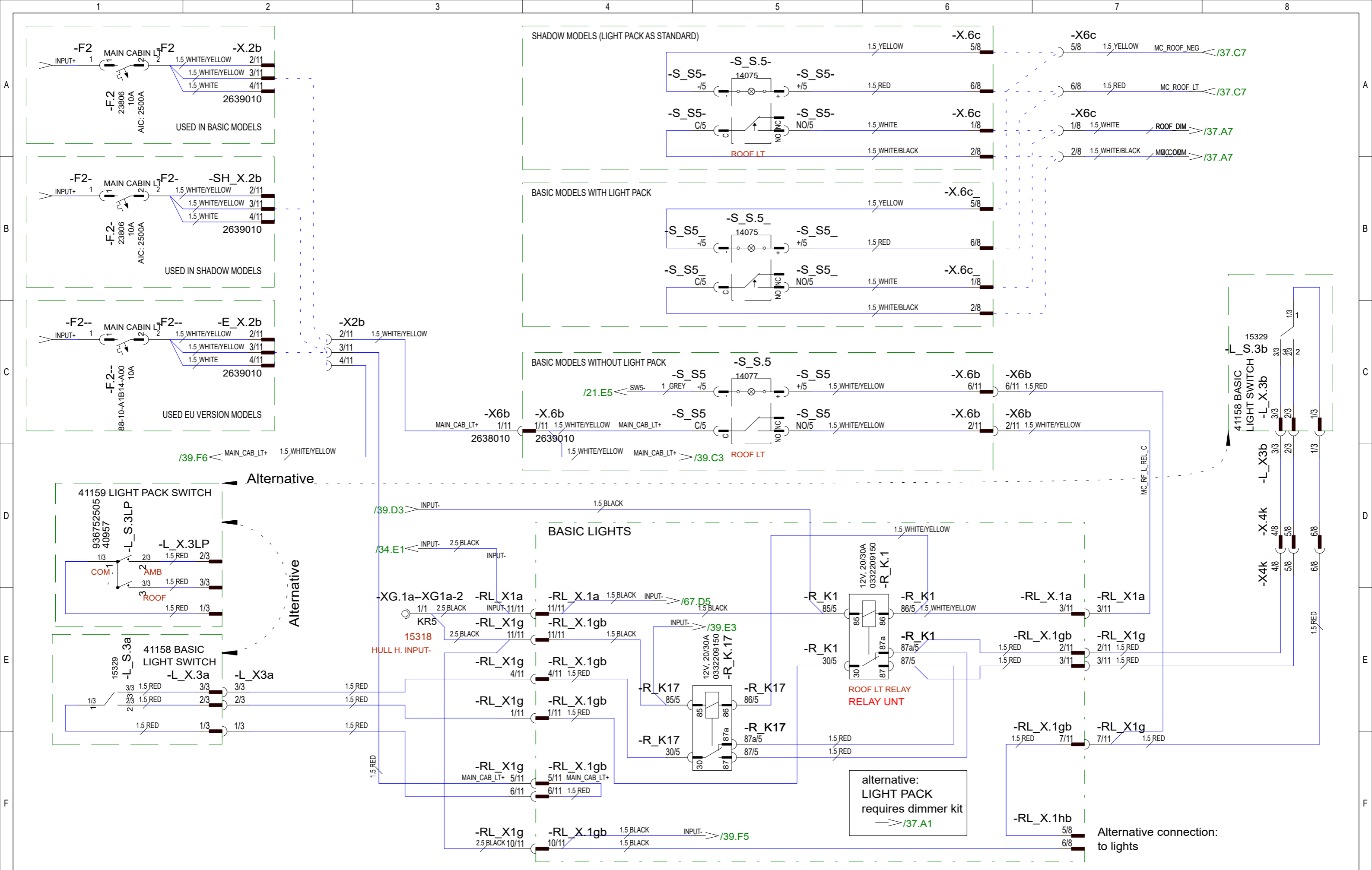

10.10.2023	PF	F22: 2004916; Not modified	Date	14.1.2019
12.3.2024	PF	G23; 2005054; Added LX3 switches & R_K17, LP option built, S5->mom	Drawing by	TuM
17.2.2023	RK	F21: NOT MODIFIED	Sheet rev.	23
Date of modification	Modified by	Description	Project rev.	G



Axopar	Sub-product code	Product code	Project ID
Boat	37 MY20	HL	36 / 213
Boat model	MAIN CABIN LIGHT, SPOT - DIAGRAM	Loc	Sheet

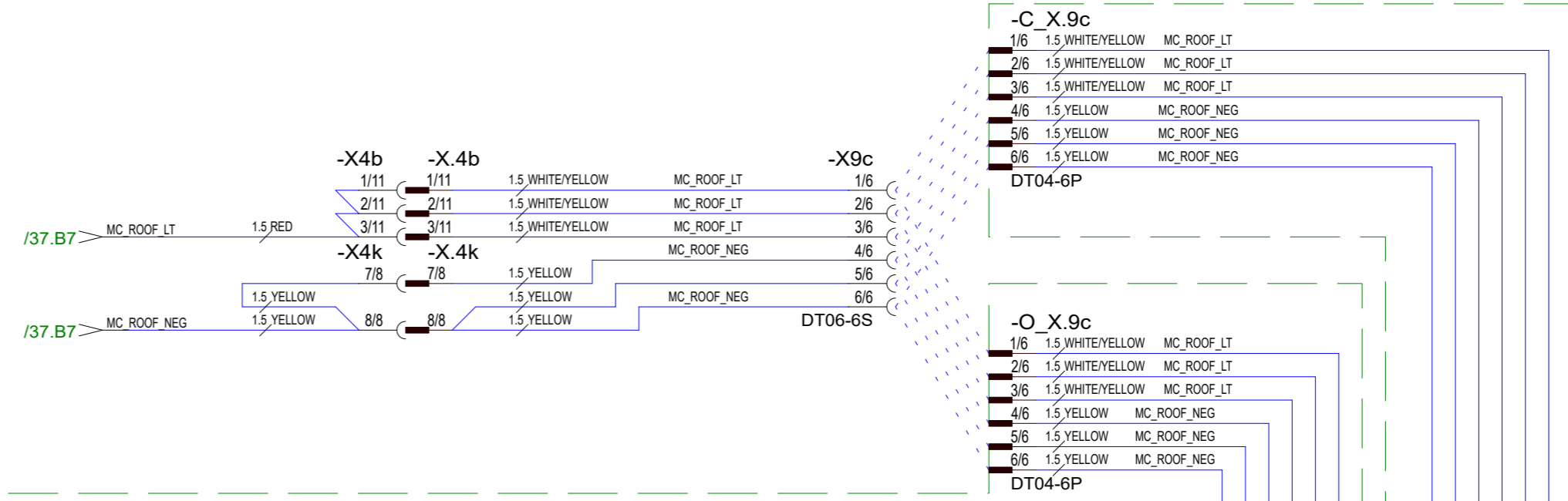

ONLY IN SUN-TOP VARIANT

ONLY IN XC CROSS CABIN VARIANT

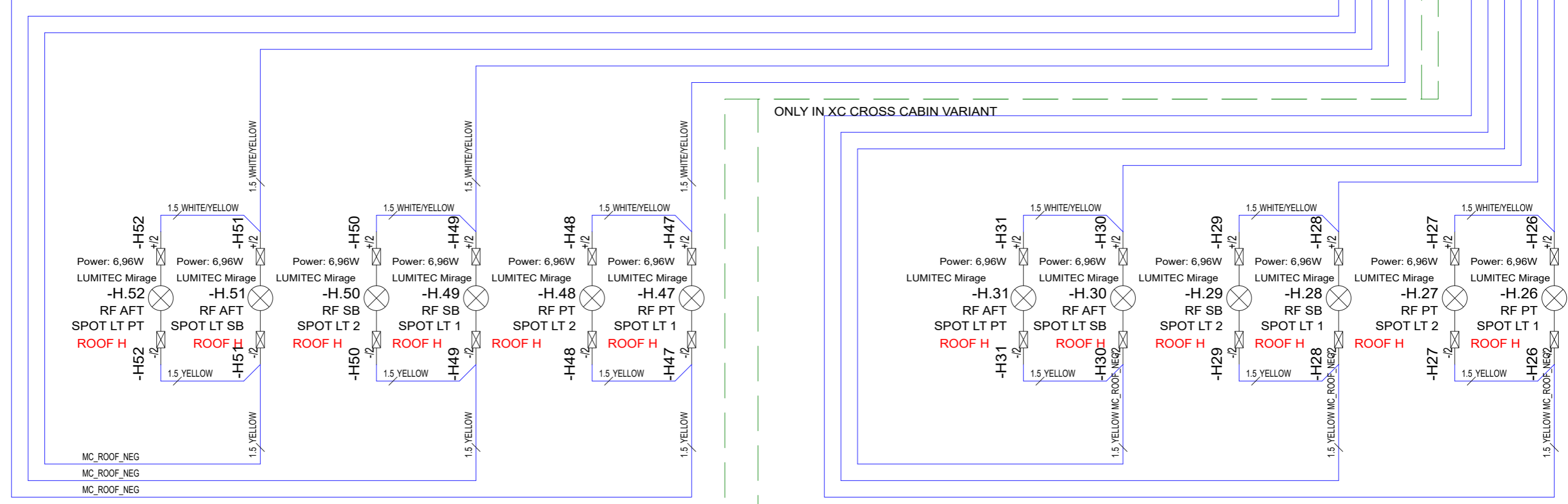

10.10.2023	PF	F22: 2004916; Not modified	Date	20.4.2020
20.2.2024	PF	G23; 2005054; Light return paths modified	Drawing by	TuM
17.2.2023	RK	F21: NOT MODIFIED	Sheet rev.	23
Date of modification	Modified by	Description	Project rev.	G



Axopar	Boat	37 MY20	Boat model	Sub-product code	Product code	Project ID
MAIN CABIN LIGHT, SPOT - DIAGRAM			Title	HL	Loc	38 / 213
						Sheet

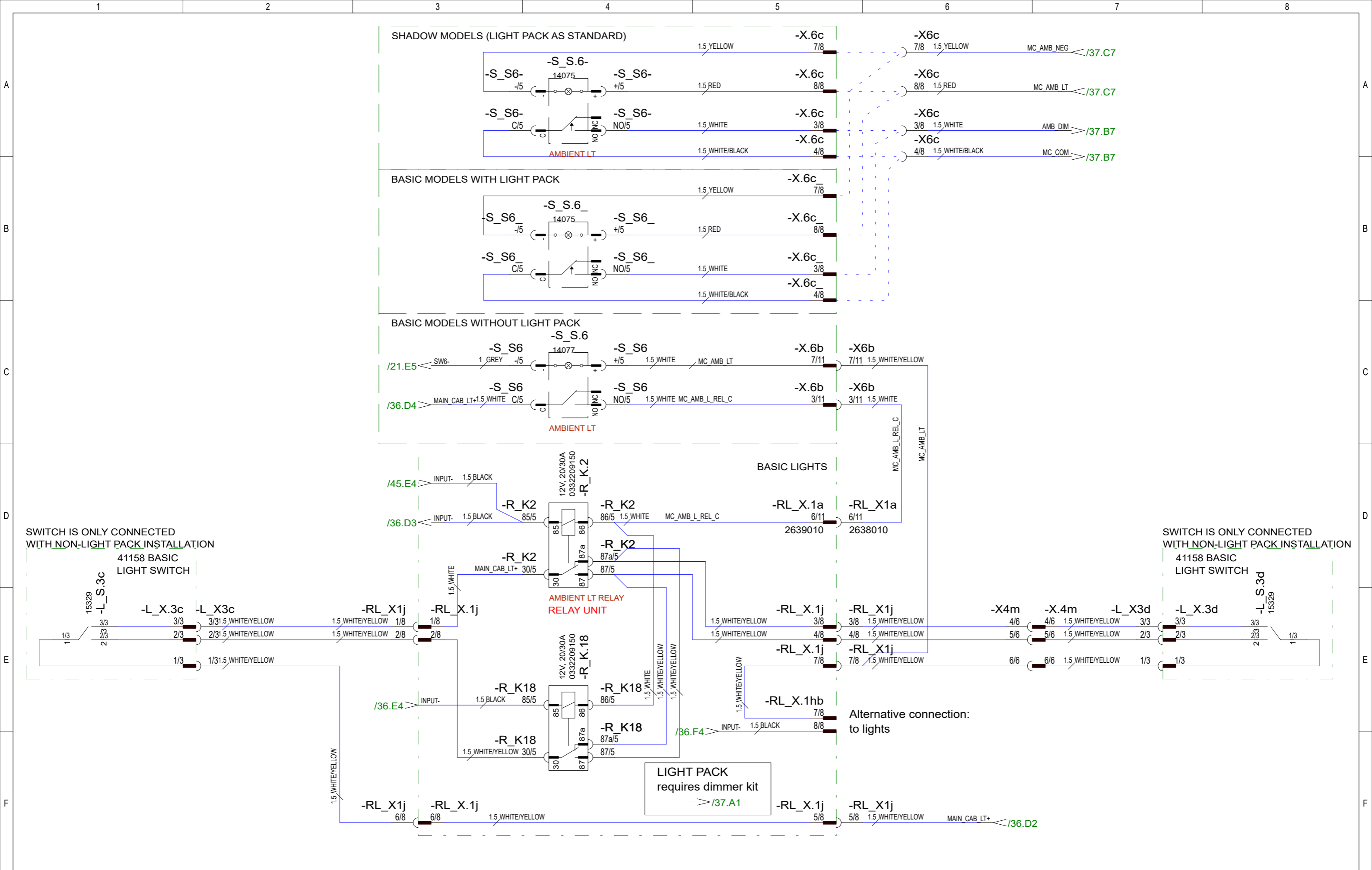

10.10.2023	PF	F22: 2004916; Not modified	Date	14.1.2019
20.2.2024	PF	G23; 2005054; Added LX3 switches & R_K18, LP option built, S6->mom	Drawing by	TuM
17.2.2023	RK	F21: NOT MODIFIED	Sheet rev.	23
Date of modification	Modified by	Description	Project rev.	G



Axopar					
Boat	37 MY20	Sub-product code	Product code	Project ID	
Boat model		MAIN CABIN LIGHT, AMBIENT - DIAGRAM		HL	39 / 213
		Title		Loc	

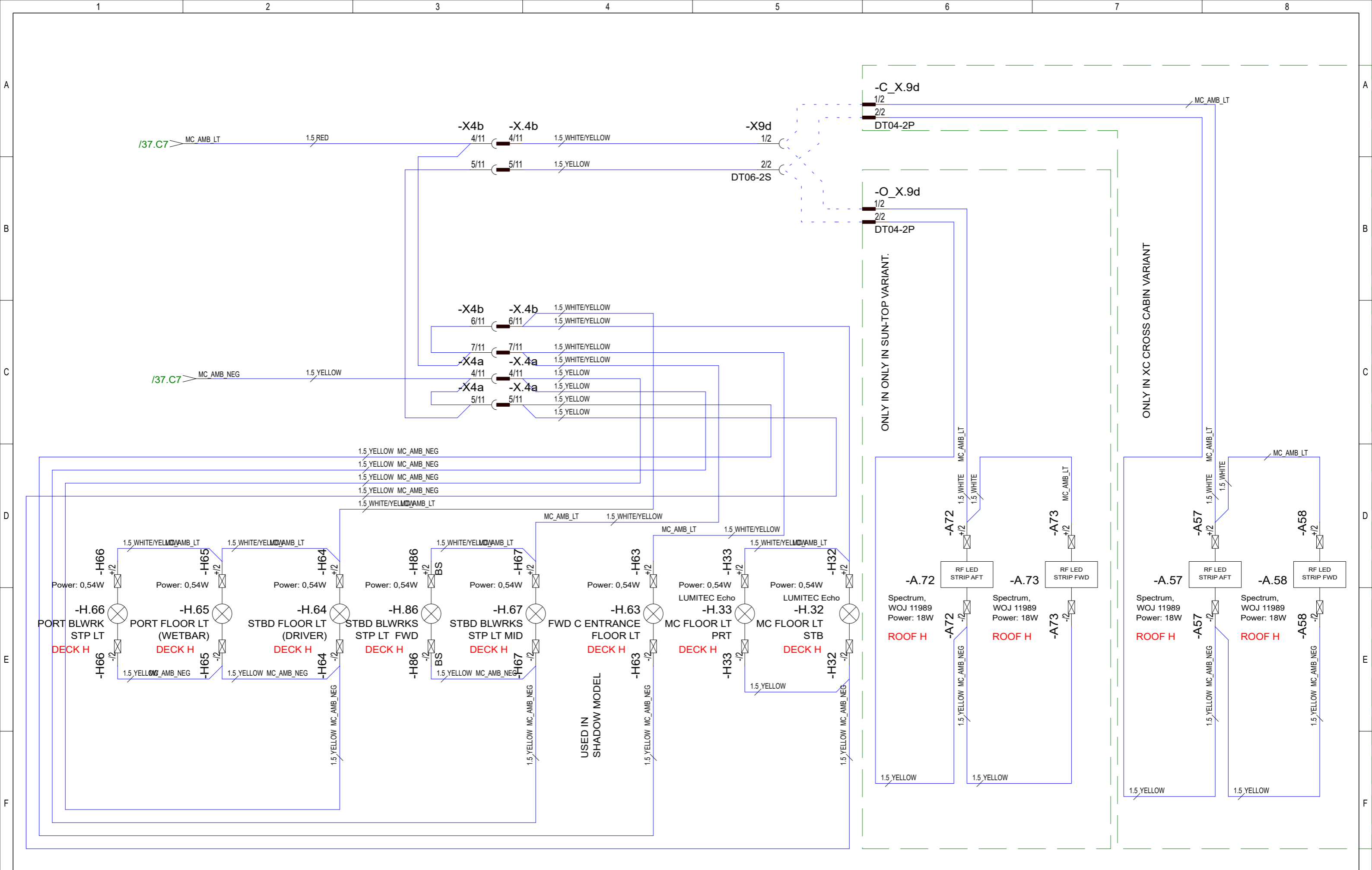

10.10.2023	PF	F22: 2004916; Not modified	Date	20.4.2020		Axopar				
20.2.2024	PF	G23; 2005054; Light return paths modified	Drawing by	TuM		Boat	Sub-product code	Product code	Project ID	
17.2.2023	RK	F21: NOT MODIFIED	Sheet rev.	23		37 MY20	MAIN CABIN LIGHT, AMBIENT - DIAGRAM		HL	40 / 213
Date of modification	Modified by	Description	Project rev.	G		Boat model	Title	Loc	Sheet	

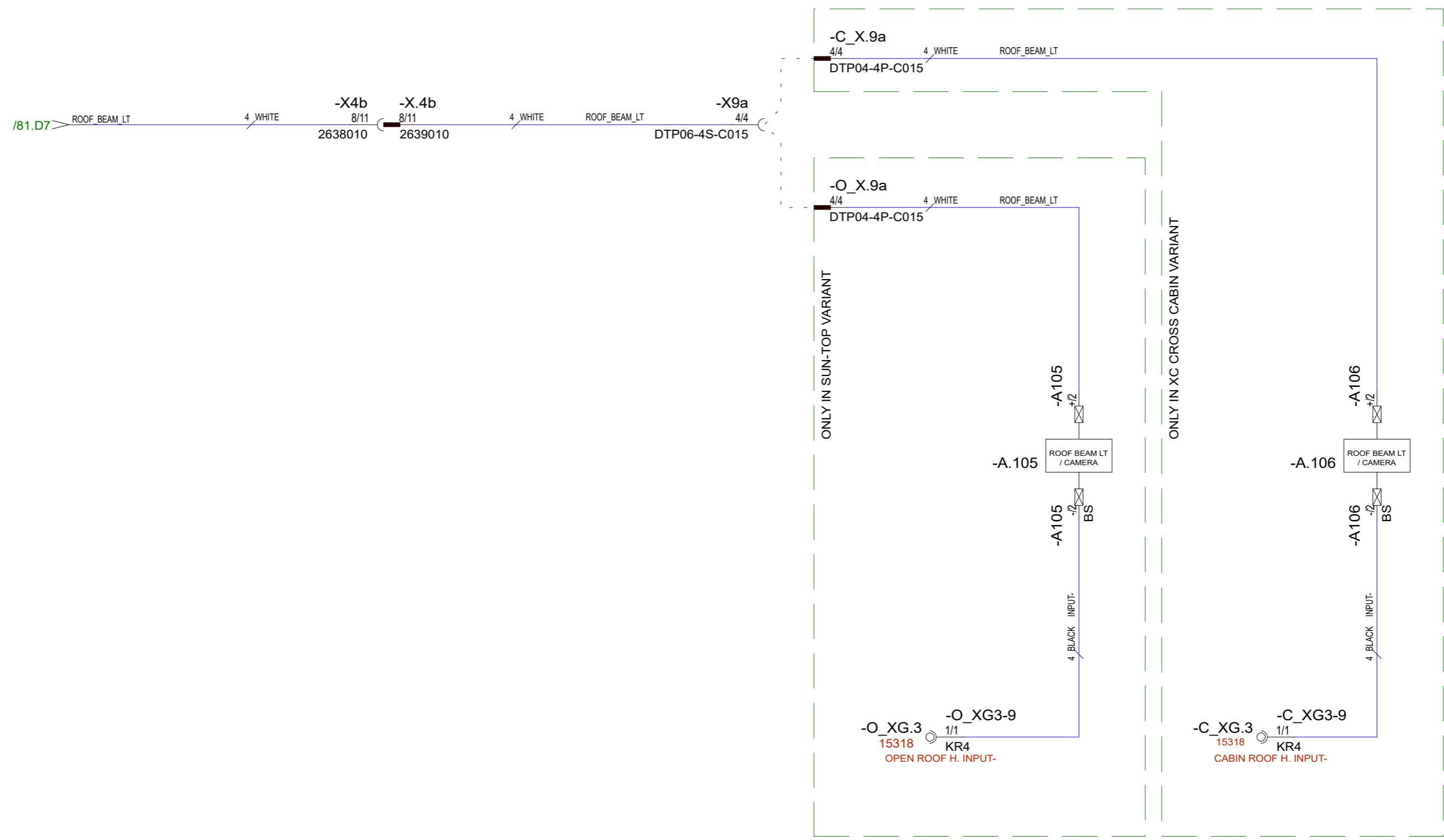

10.10.2023	PF	F22: 2004916; Not modified	Date	30.03.2021
20.2.2024	PF	G23; 2005054; Not modified	Drawing by	TT
17.2.2023	RK	F21: ROOF BEAM LIGHT WIRE	Sheet rev.	23
Date of modification	Modified by	Description	Project rev.	G



Axopar			
Boat	37 MY20	Sub-product code	Product code
Boat model		ROOF BEAM LIGHT, CAMERA - DIAGRAM	Project ID
		HL	41/ 213
		Loc	Sheet

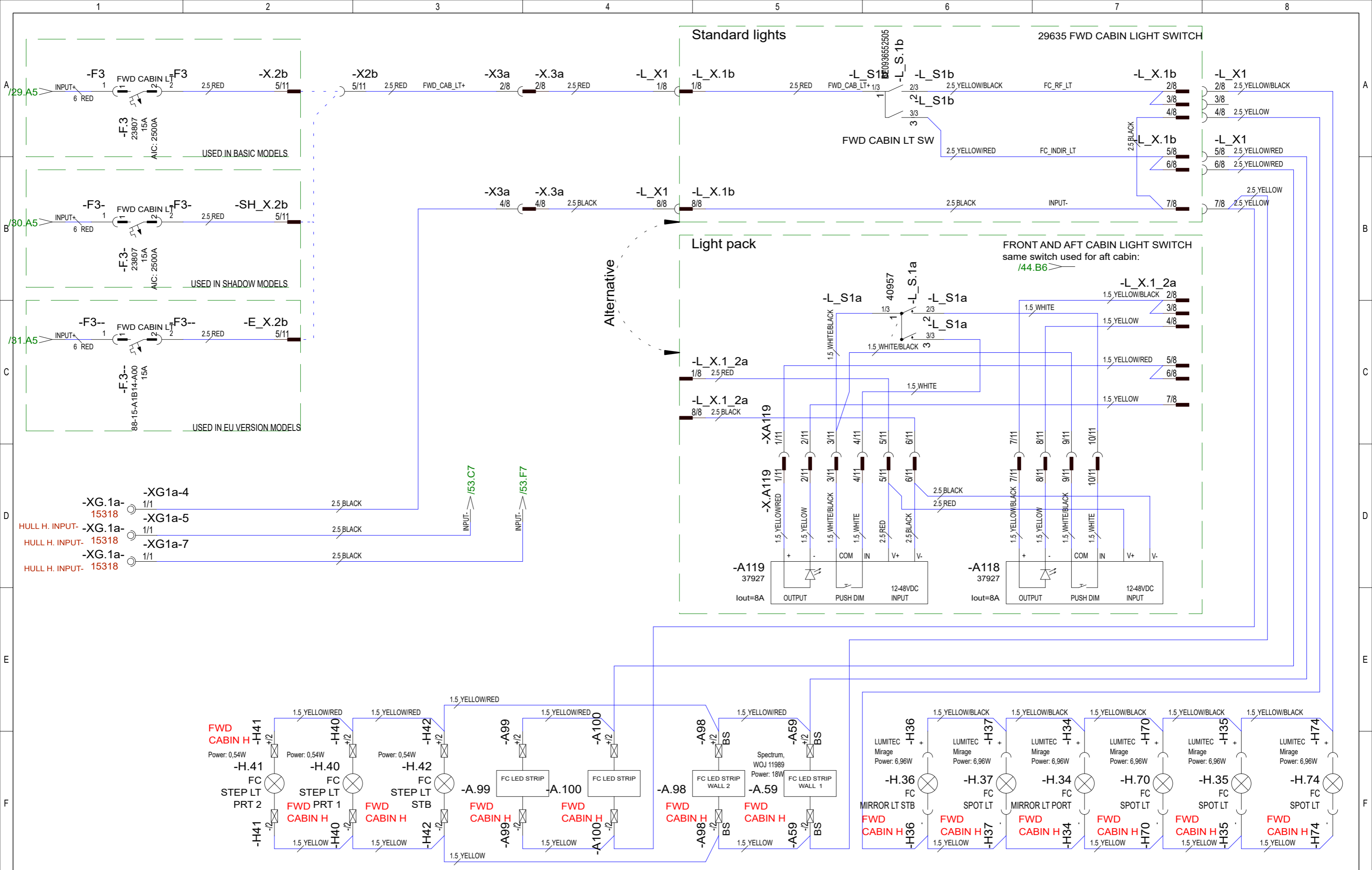

10.10.2023	PF	F22: 2004916; Not modified	Date	14.1.2019	NAVIX designed solutions	Axopar			
20.2.2024	PF	G23; 2005054; Std switch modif., LP option built, light return paths modif.	Drawing by	TuM		Boat	37 MY20	Sub-product code	Product code
17.2.2023	RK	F21: NOT MODIFIED	Sheet rev.	23	Copyright by		FWD CABIN LIGHTS	HL	42 / 213
Date of modification	Modified by	Description	Project rev.	G		Boat model	- DIAGRAM	Loc	Sheet

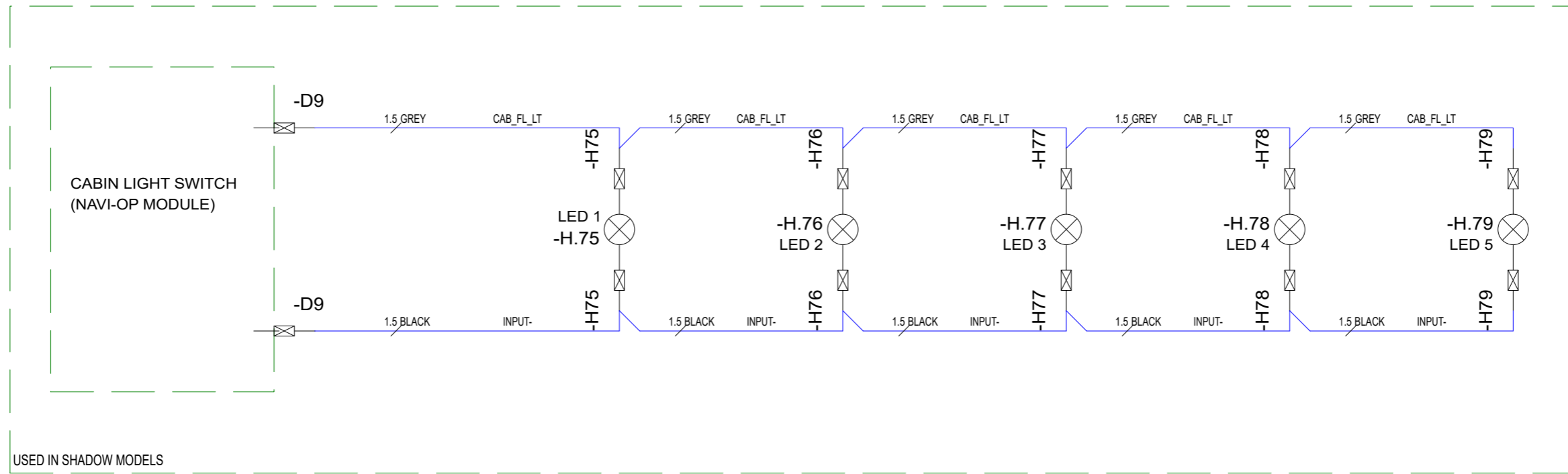

10.10.2023	PF	F22: 2004916; Not modified	Date	6.11.2020
20.2.2024	PF	G23; 2005054; Not modified	Drawing by	TuM
17.2.2023	RK	F21: NOT MODIFIED	Sheet rev.	23
Date of modification	Modified by	Description	Project rev.	G



Axopar			
Boat	37 MY20	FWD CABIN FLOOR LIGHTS - DIAGRAM	43 / 213
Boat model		HL	Sheet
		Loc	

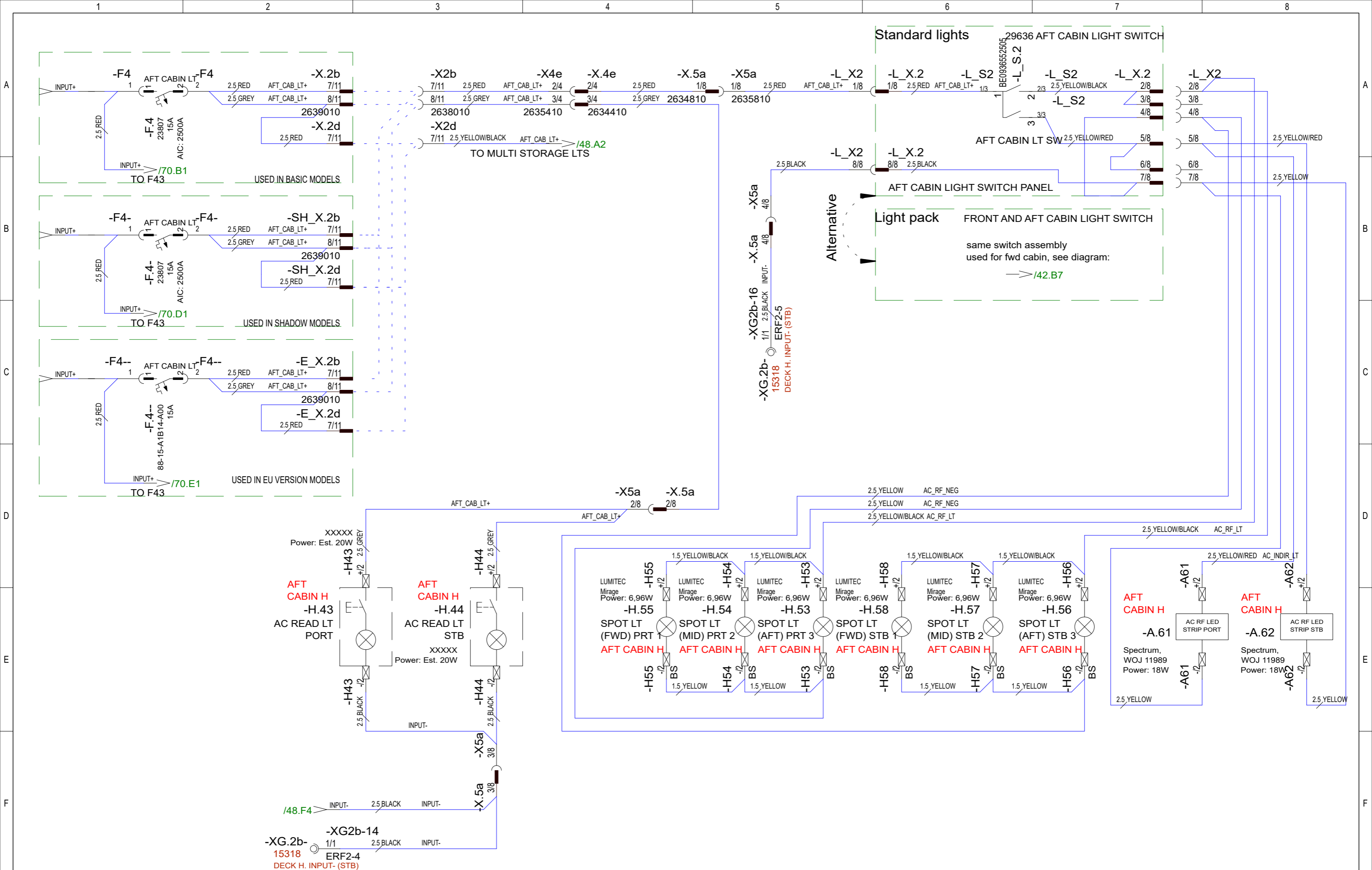

10.10.2023	PF	F22: 2004916; Not modified	Date	14.1.2019		Axopar				
20.2.2024	PF	G23; 2005054; Std switch modif., LP option built, light return paths modif.	Drawing by	TuM		Boat	37 MY20	Sub-product code	Product code	Project ID
17.2.2023	RK	F21: NOT MODIFIED	Sheet rev.	23		Boat model		AFT CABING LIGHTS - DIAGRAM	HL	44 / 213
Date of modification	Modified by	Description	Project rev.	G	Copyright by		Title	Loc	Sheet	

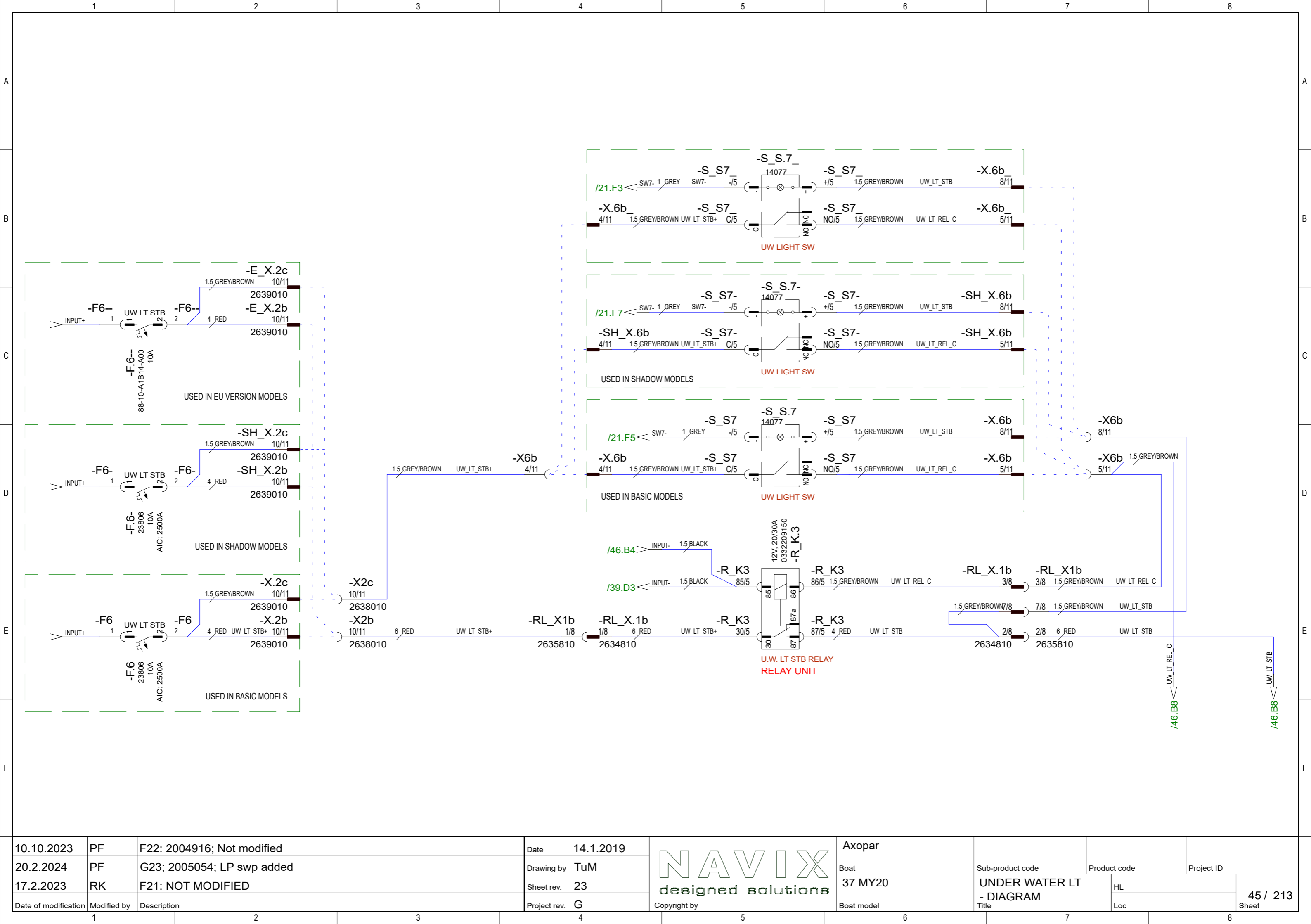

10.10.2023	PF	F22: 2004916; Not modified	Date	14.1.2019
20.2.2024	PF	G23; 2005054; LP swp added	Drawing by	TuM
17.2.2023	RK	F21: NOT MODIFIED	Sheet rev.	23
Date of modification	Modified by	Description	Project rev.	G

Copyright by

Axopar

Boat: 37 MY20

Boat model:

Sub-product code

Product code

Project ID

UNDER WATER LT - DIAGRAM

Title

HL

Loc

45 / 213

Sheet

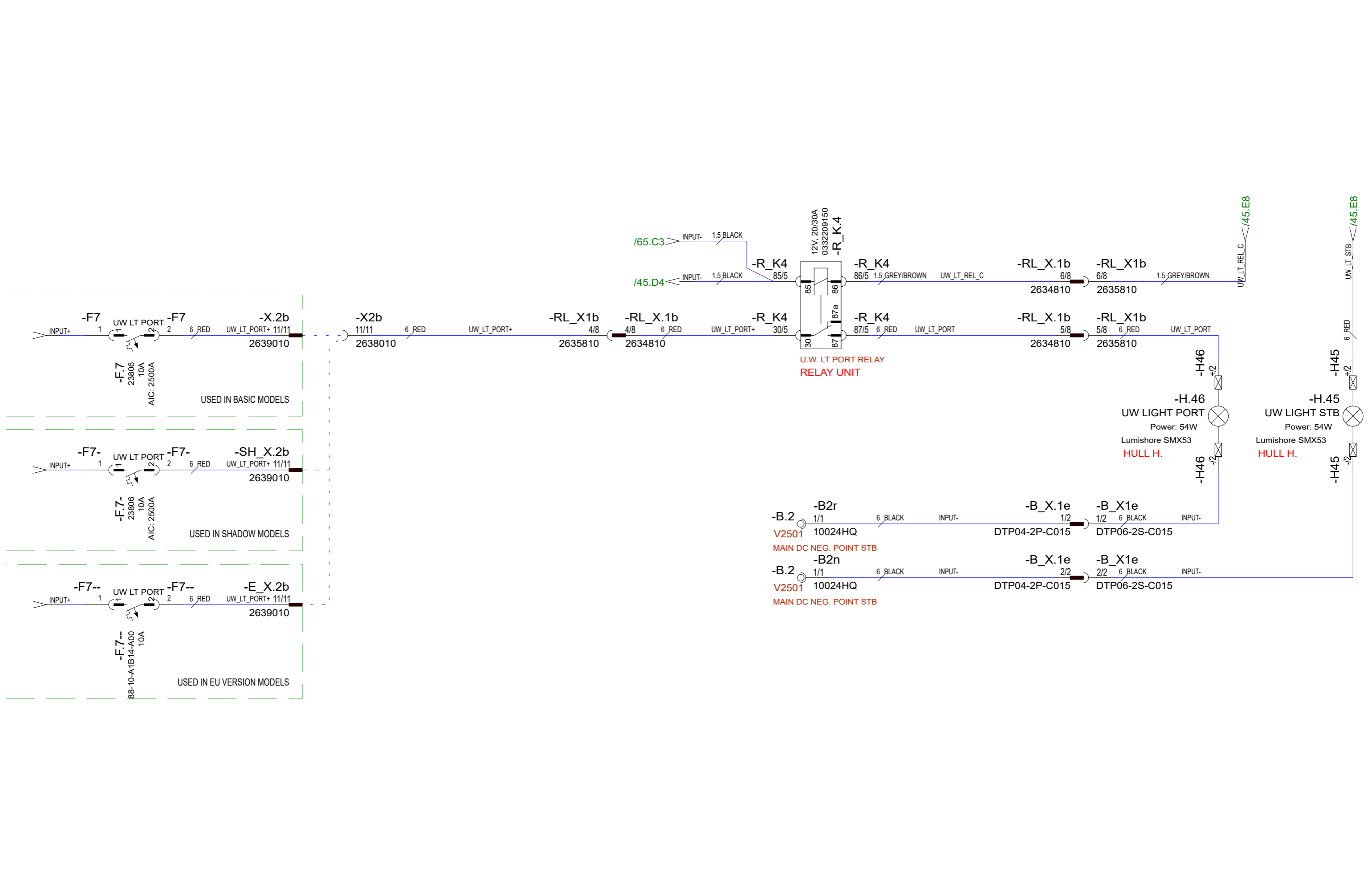

10.10.2023	PF	F22: 2004916; Not modified	Date	14.1.2019	 Copyright by	Axopar			
20.2.2024	PF	G23; 2005054; Not modified	Drawing by	TuM		Boat	Sub-product code	Product code	Project ID
17.2.2023	RK	F21: NOT MODIFIED	Sheet rev.	23		37 MY20	UNDER WATER LT		HL
Date of modification	Modified by	Description	Project rev.	G		Boat model	Title	Loc	46 / 213 Sheet

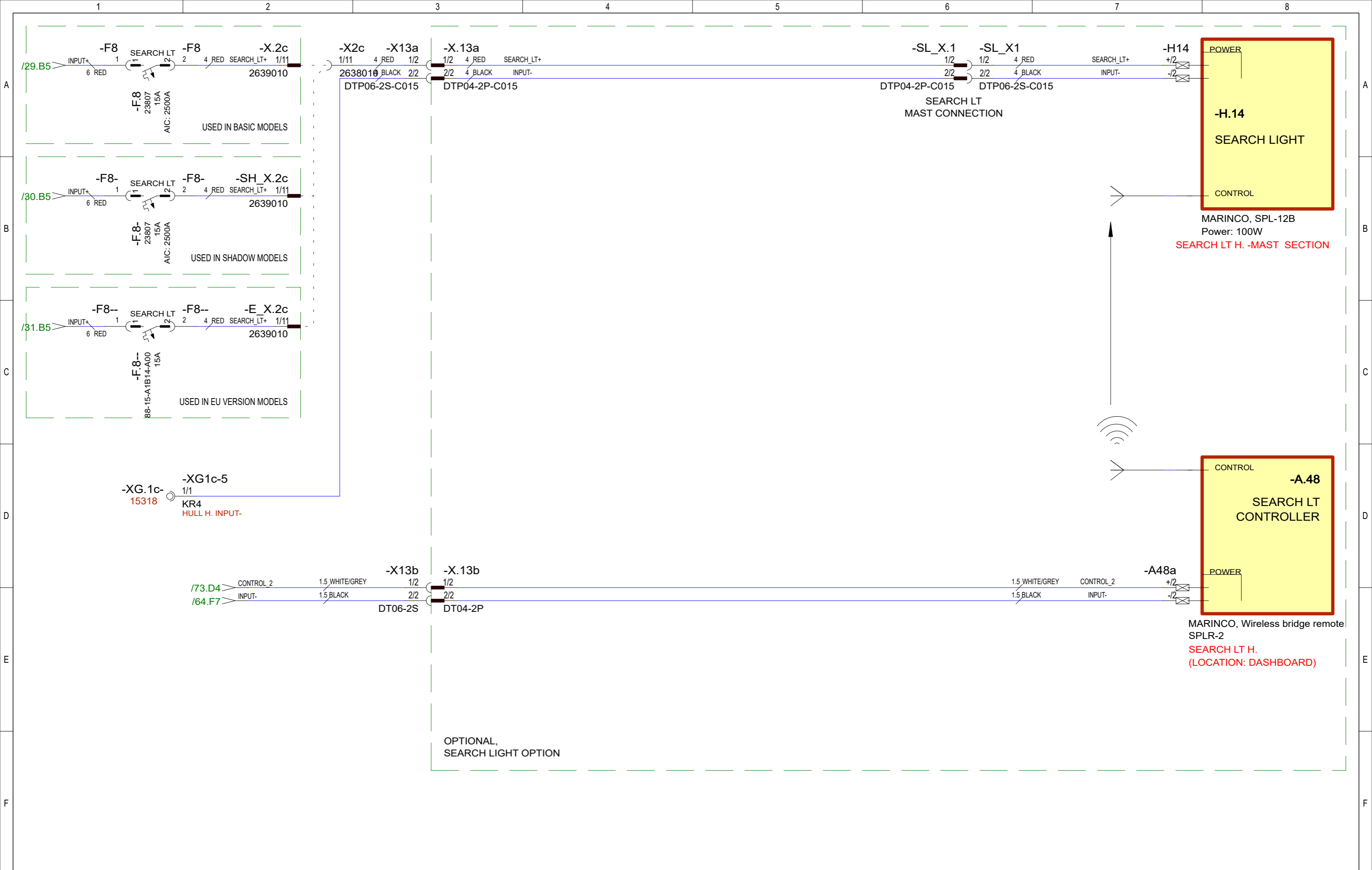

10.10.2023	PF	F22: 2004916; Not modified	Date	14.1.2019	NAVIX designed solutions	Axopar			
20.2.2024	PF	G23; 2005054; Not modified	Drawing by	TuM		Boat	37 MY20	Sub-product code	Product code
17.2.2023	RK	F21: NOT MODIFIED	Sheet rev.	23	Copyright by	Boat model	SEARCH LIGHT - DIAGRAM	HL	47 / 213 Sheet
Date of modification	Modified by	Description	Project rev.	G				Title	

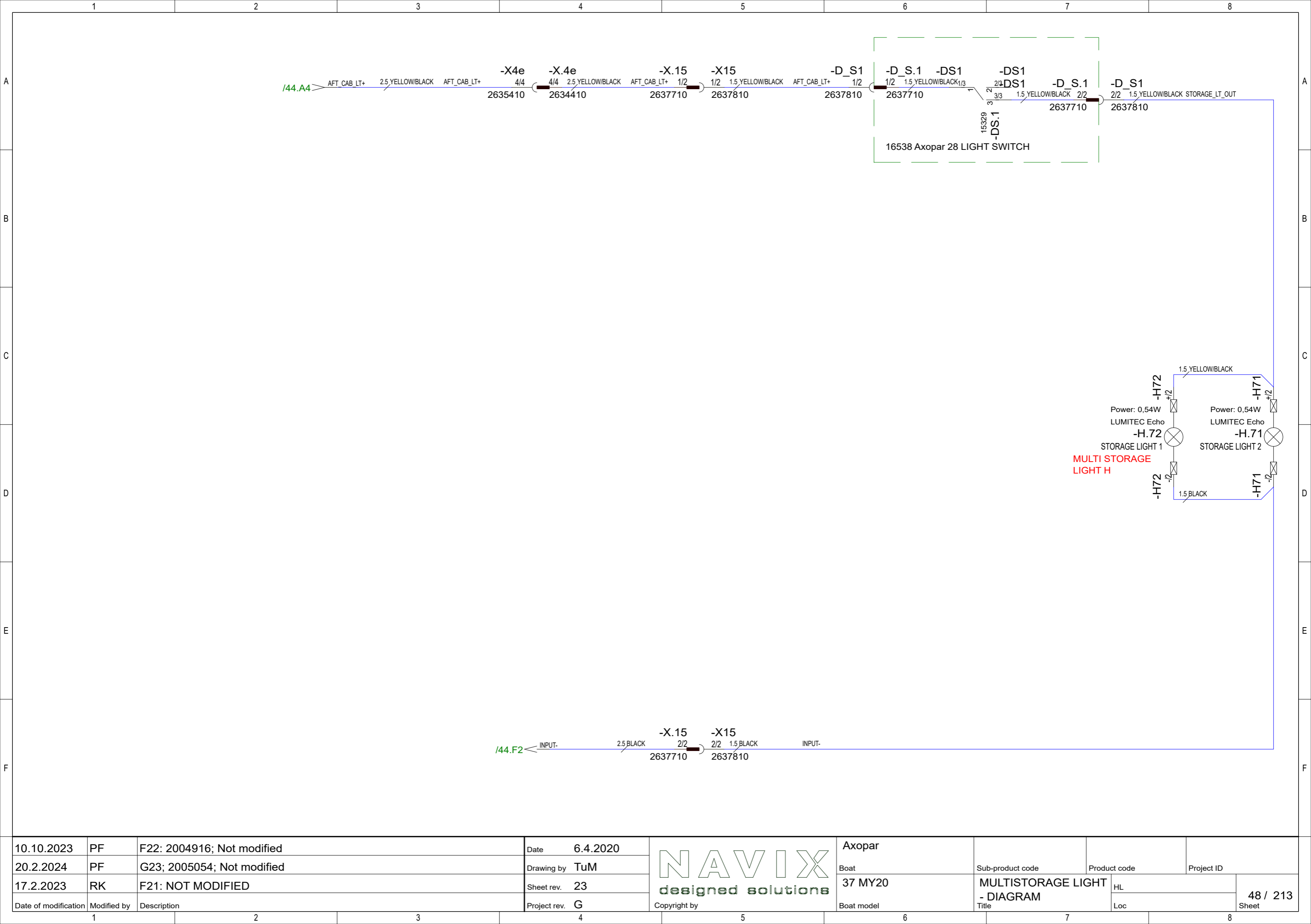

10.10.2023	PF	F22: 2004916; Not modified	Date	6.4.2020
20.2.2024	PF	G23; 2005054; Not modified	Drawing by	TuM
17.2.2023	RK	F21: NOT MODIFIED	Sheet rev.	23
Date of modification	Modified by	Description	Project rev.	G

 designed solutions
 Copyright by

Axopar				
Boat	37 MY20	Sub-product code	Product code	Project ID
Boat model		MULTISTORAGE LIGHT	HL	48 / 213
		- DIAGRAM	Loc	

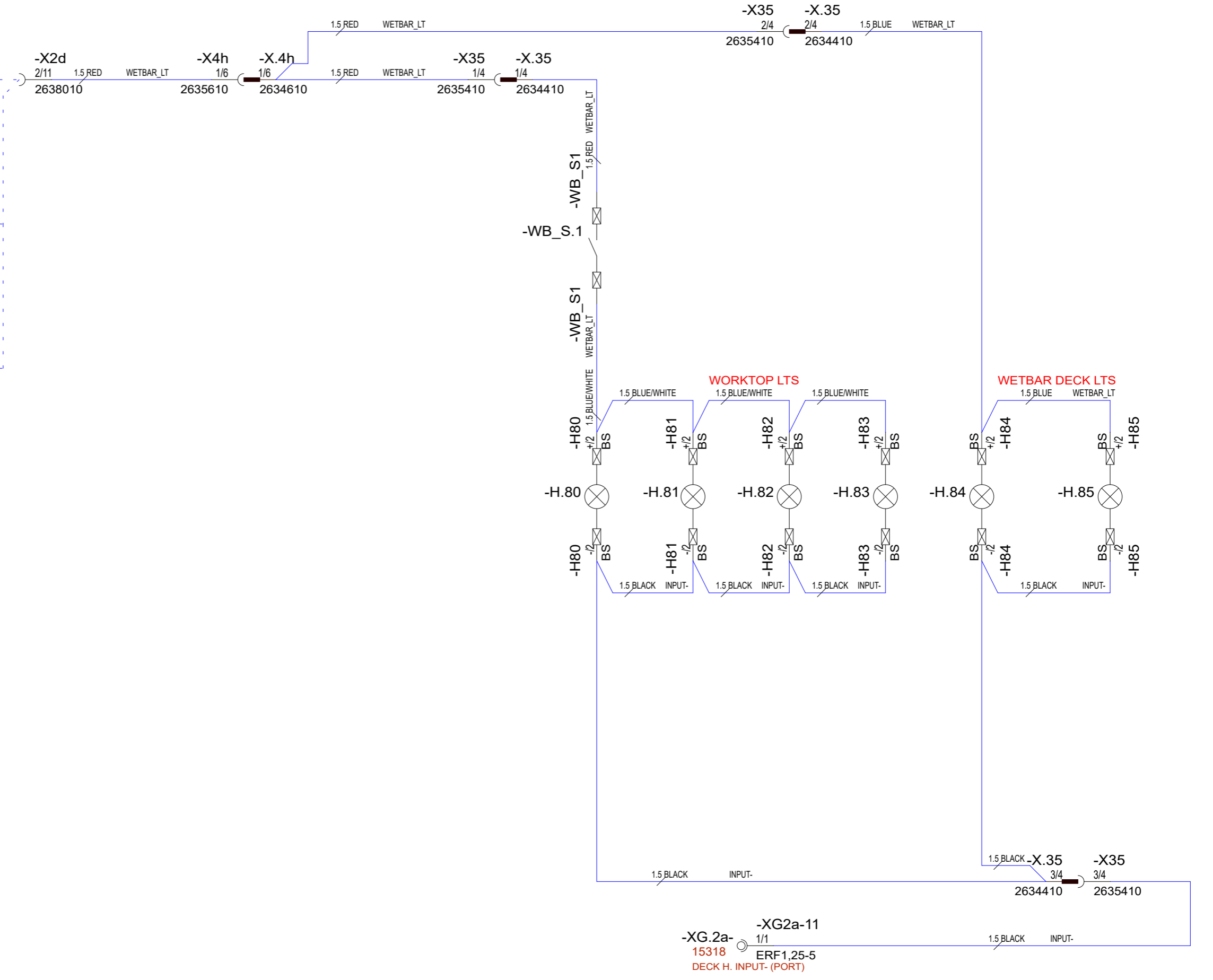
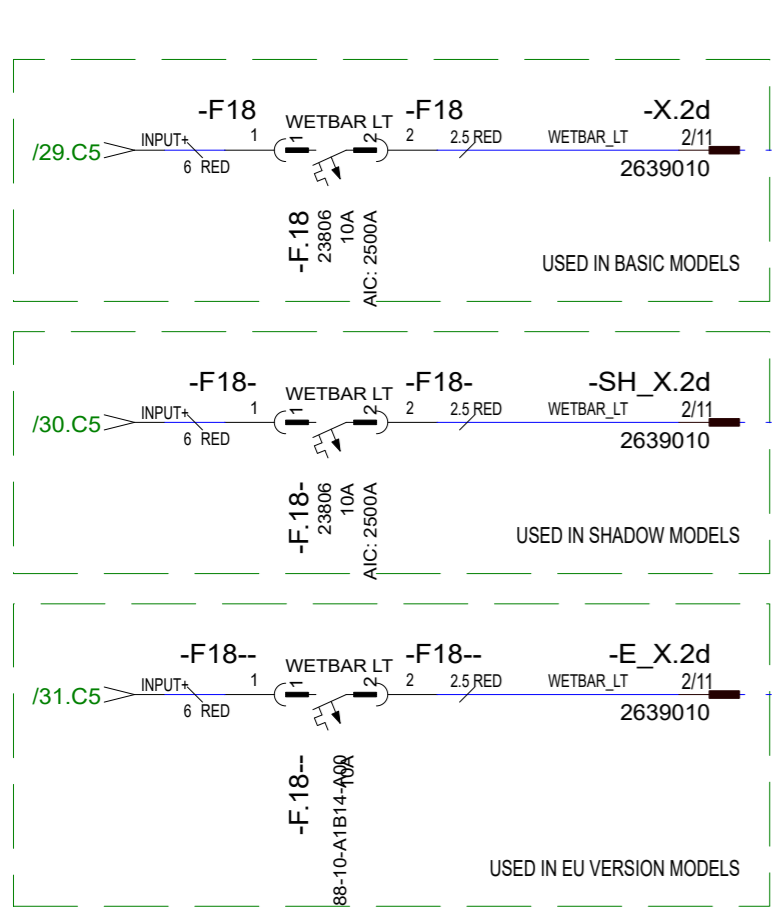

10.10.2023	PF	F22; 2004916; Not modified	Date	6.2.2023
20.2.2024	PF	G23; 2005054; Not modified	Drawing by	TT
			Sheet rev.	23
Date of modification	Modified by	Description	Project rev.	G



Axopar				
Boat	37 MY20 SHADOW	Sub-product code	Product code	Project ID
Boat model		WETBAR LIGHTS HARNESS	HL	49 / 213
		Title	Loc	Sheet

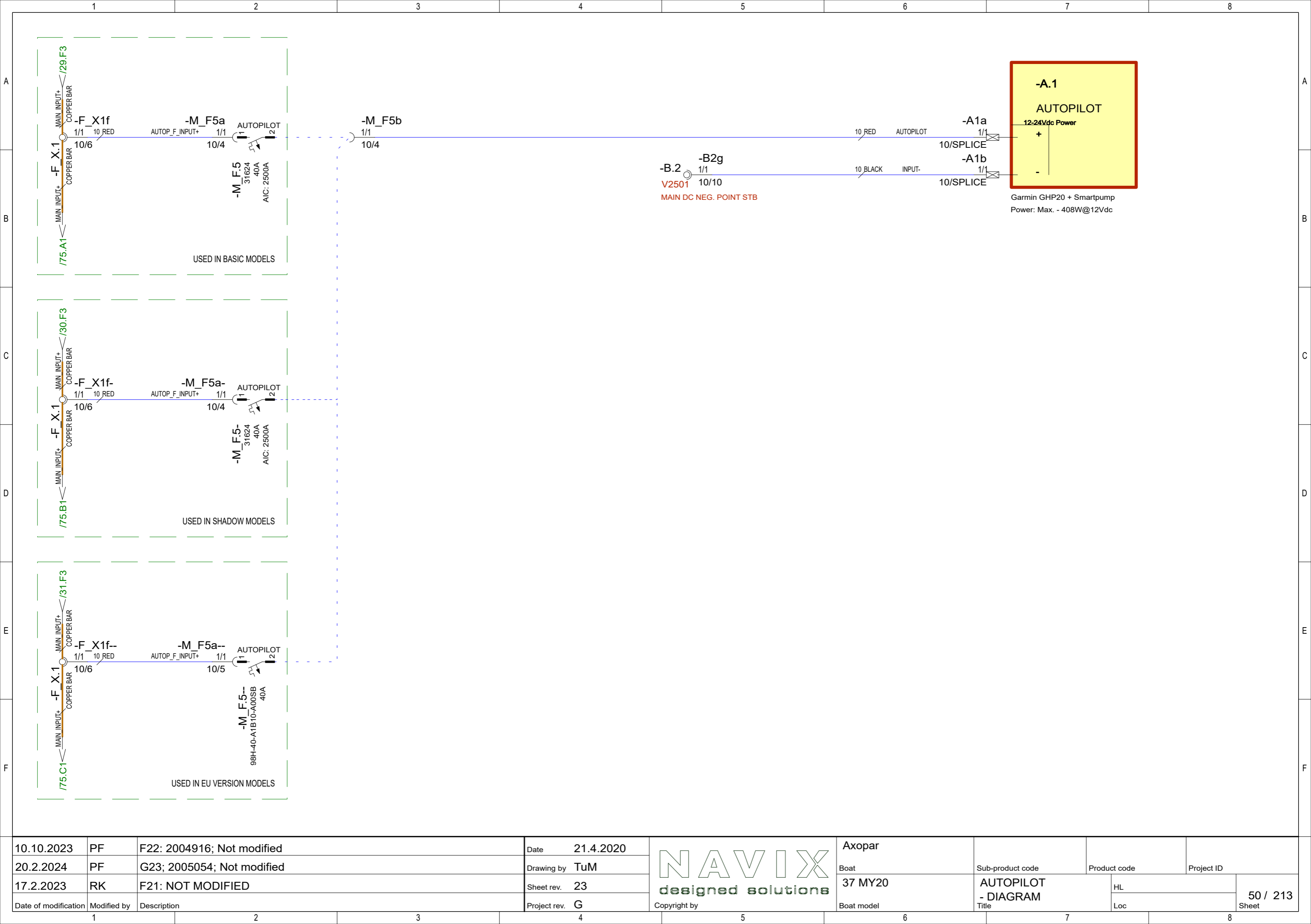

10.10.2023	PF	F22: 2004916; Not modified
20.2.2024	PF	G23; 2005054; Not modified
17.2.2023	RK	F21: NOT MODIFIED
Date of modification	Modified by	Description

Date	21.4.2020
Drawing by	TuM
Sheet rev.	23
Project rev.	G



Axopar
Boat
37 MY20
Boat model

Sub-product code	Product code	Project ID
AUTOPILOT		HL
- DIAGRAM		Loc
Title		

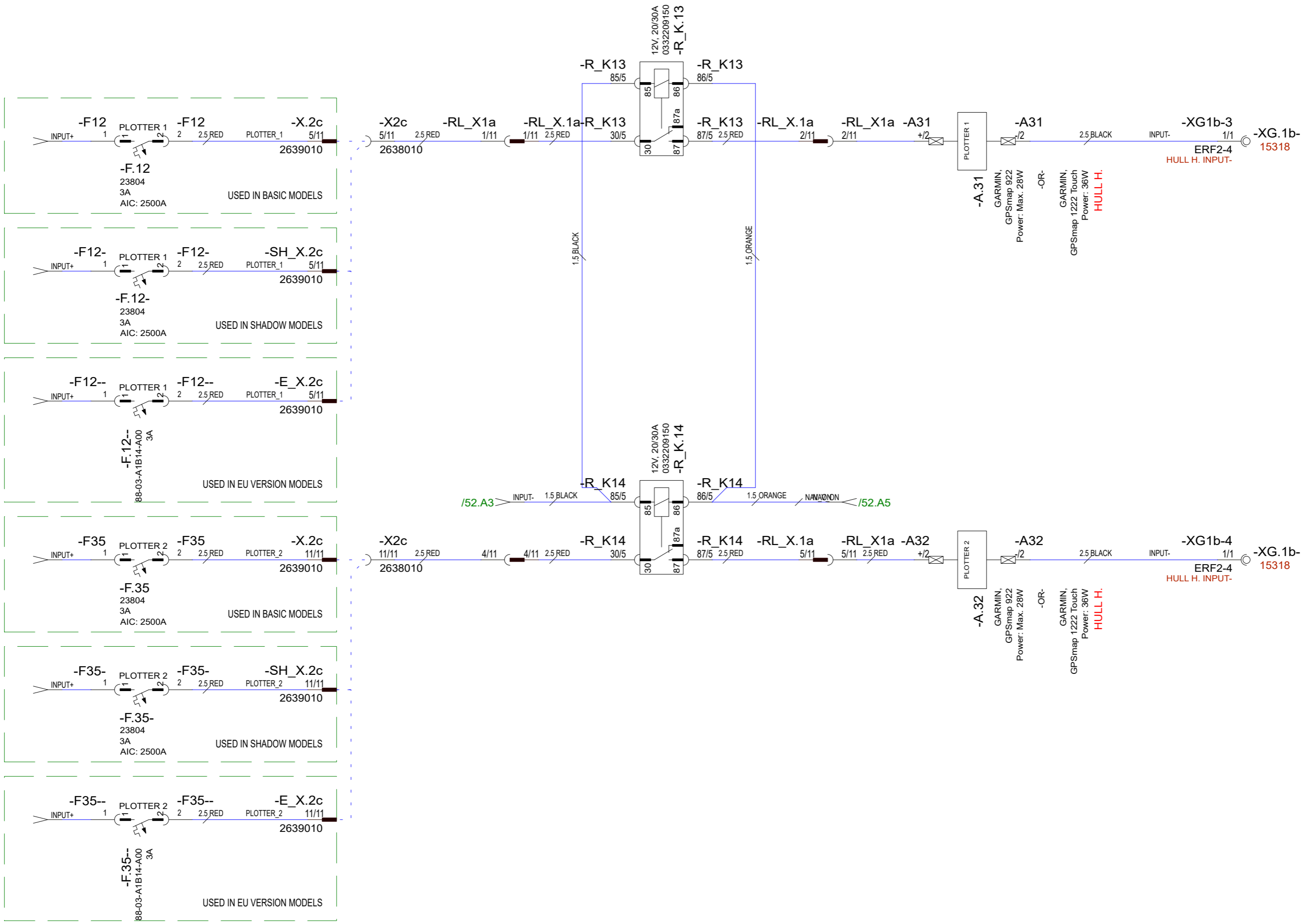

10.10.2023	PF	F22: 2004916; Not modified	Date	14.1.2019
20.2.2024	PF	G23; 2005054; R_K13 & R_K14 added (nav on/off)	Drawing by	TuM
17.2.2023	RK	F21: NOT MODIFIED	Sheet rev.	23
Date of modification	Modified by	Description	Project rev.	G



Axopar	Boat	37 MY20	Sub-product code	NAV. EQUIPMENT	Product code	HL	Project ID	51/ 213
	Boat model		Title	- DIAGRAM		Loc		Sheet

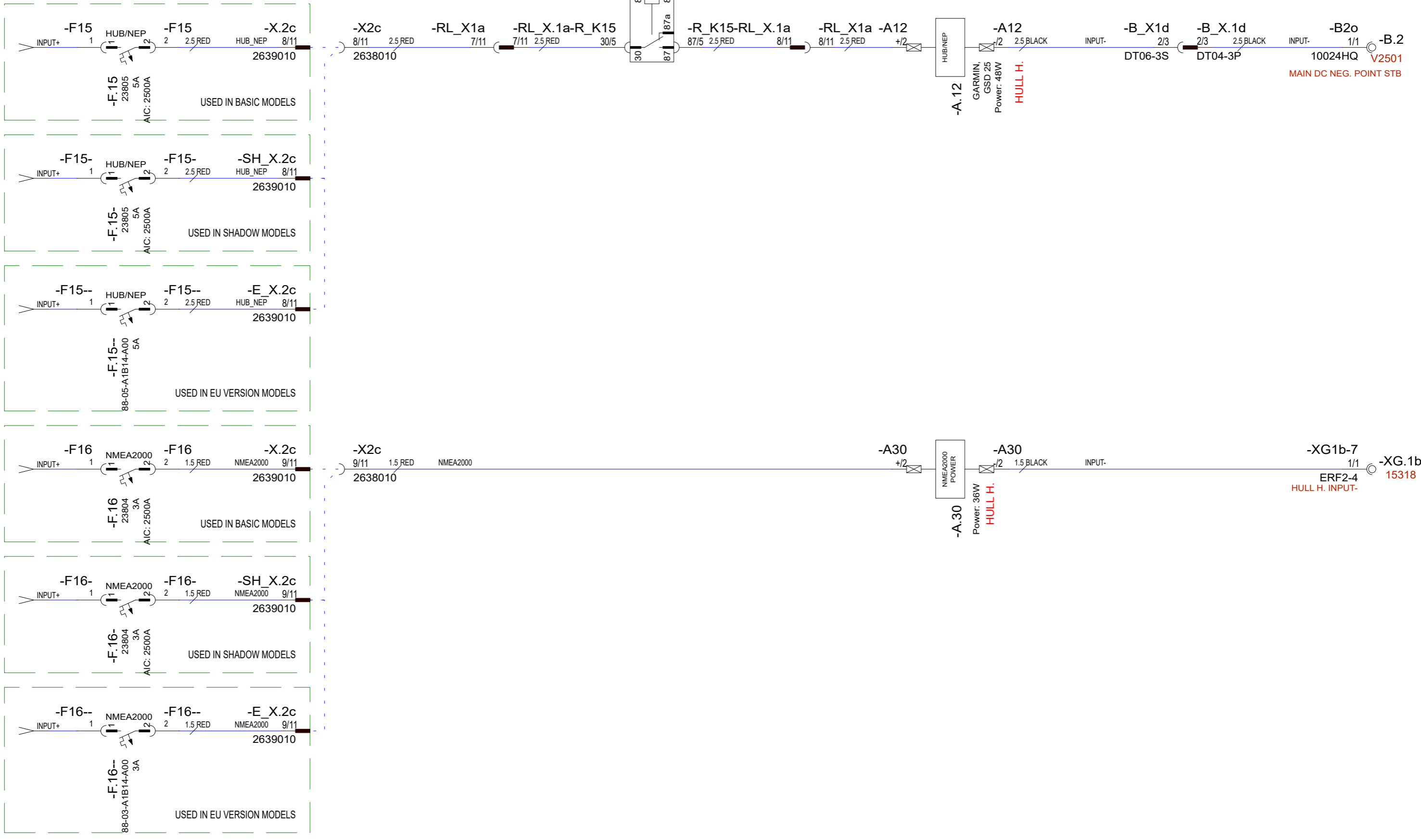

10.10.2023	PF	F22: 2004916; Not modified	Date	21.4.2020
20.2.2024	PF	G23; 2005054; R_K15 added (nav on/off)	Drawing by	TuM
17.2.2023	RK	F21: NOT MODIFIED	Sheet rev.	23
Date of modification	Modified by	Description	Project rev.	G



Axopar				
Boat	37 MY20	Sub-product code	Product code	Project ID
Boat model		NAV. EQUIPMENT - DIAGRAM	HL	52 / 213
		Title	Loc	Sheet

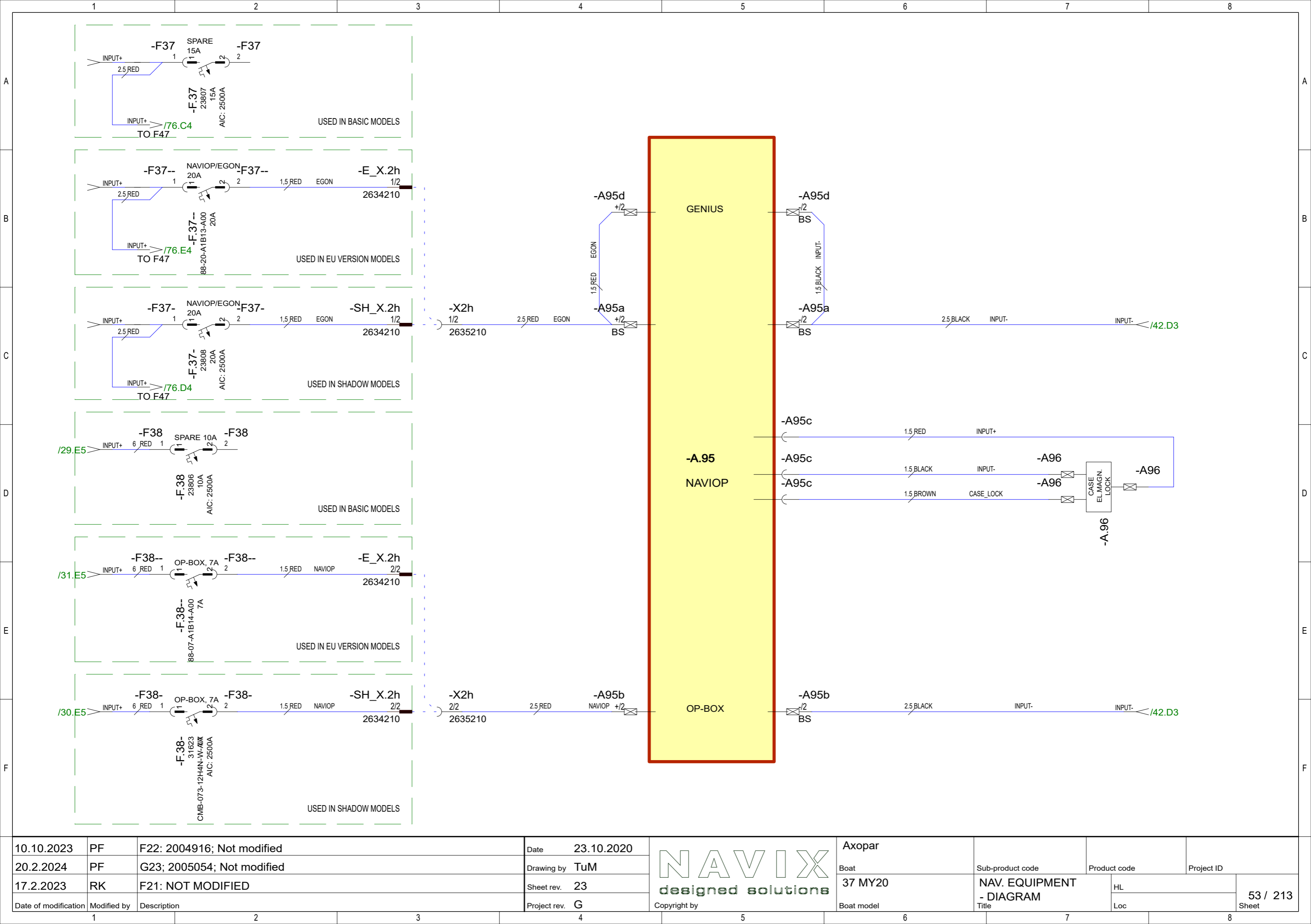

10.10.2023	PF	F22: 2004916; Not modified	Date	23.10.2020
20.2.2024	PF	G23; 2005054; Not modified	Drawing by	TuM
17.2.2023	RK	F21: NOT MODIFIED	Sheet rev.	23
Date of modification	Modified by	Description	Project rev.	G



Axopar					
Boat	37 MY20	Sub-product code	NAV. EQUIPMENT	Product code	HL
Boat model		Title	- DIAGRAM	Loc	
				53 / 213	
				Sheet	

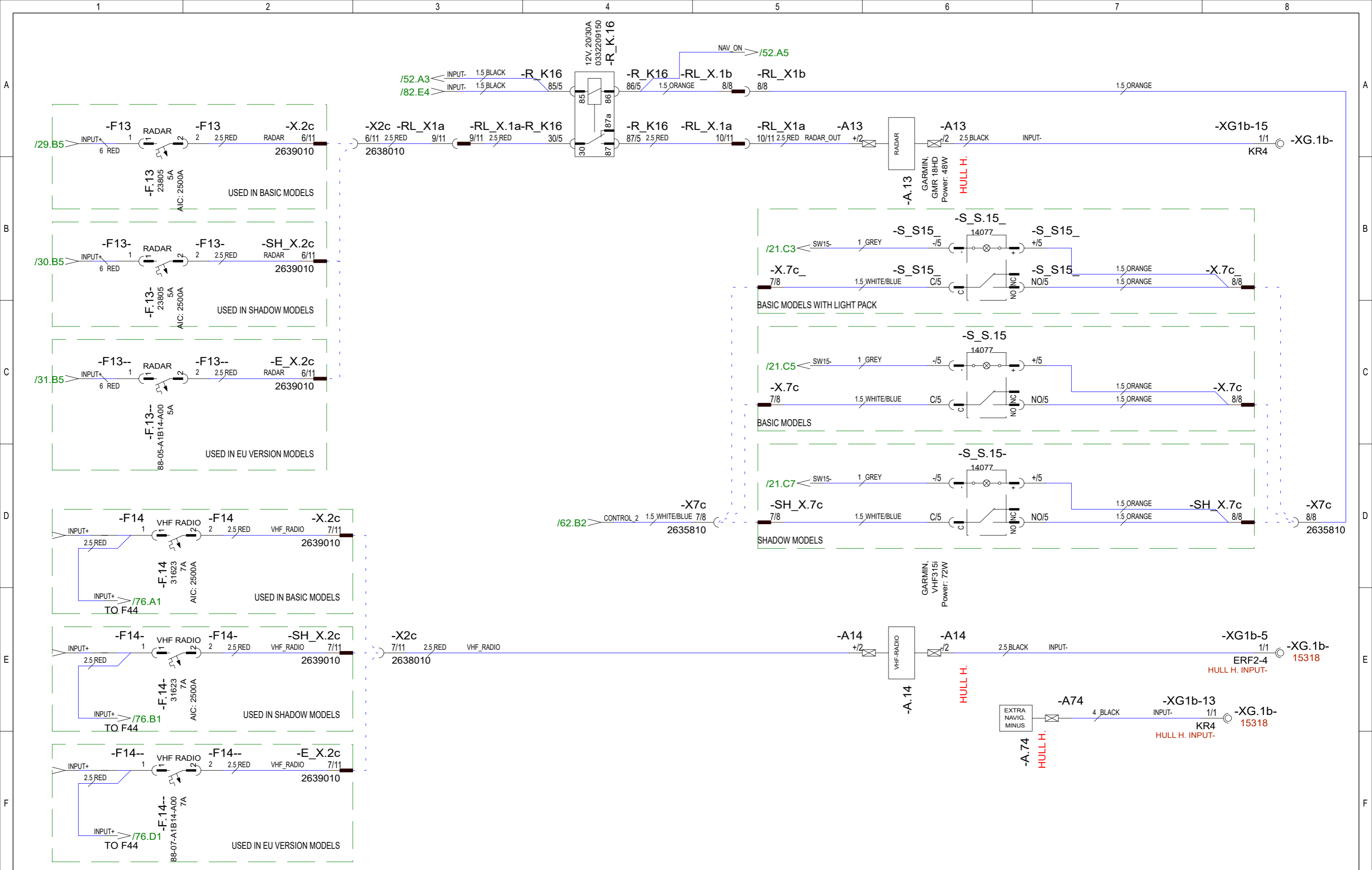

10.10.2023	PF	F22: 2004916; Not modified	Date	23.10.2020
20.2.2024	PF	G23; 2005054; R_K16 and S15 added (nav on/off)	Drawing by	TuM
17.2.2023	RK	F21: NOT MODIFIED	Sheet rev.	23
Date of modification	Modified by	Description	Project rev.	G



Axopar	Boat	37 MY20	Sub-product code	NAV. EQUIPMENT	Product code	HL	Project ID	54 / 213
	Boat model		Title	- DIAGRAM		Loc		Sheet

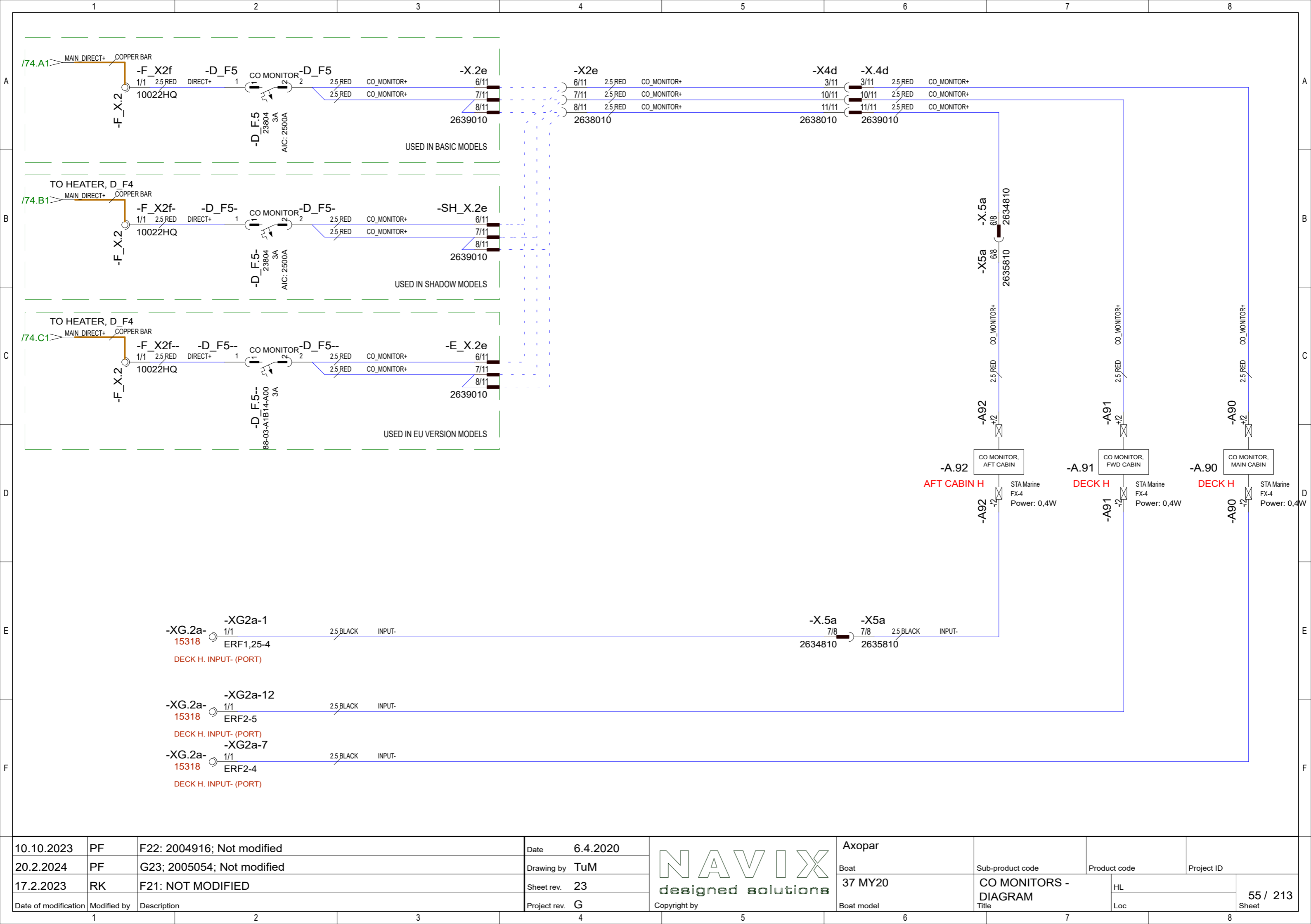

10.10.2023	PF	F22: 2004916; Not modified	Date	6.4.2020
20.2.2024	PF	G23; 2005054; Not modified	Drawing by	TuM
17.2.2023	RK	F21: NOT MODIFIED	Sheet rev.	23
Date of modification	Modified by	Description	Project rev.	G



Axopar				
Boat	37 MY20	Sub-product code	Product code	Project ID
Boat model		CO MONITORS - DIAGRAM	HL	55 / 213
		Title	Loc	Sheet

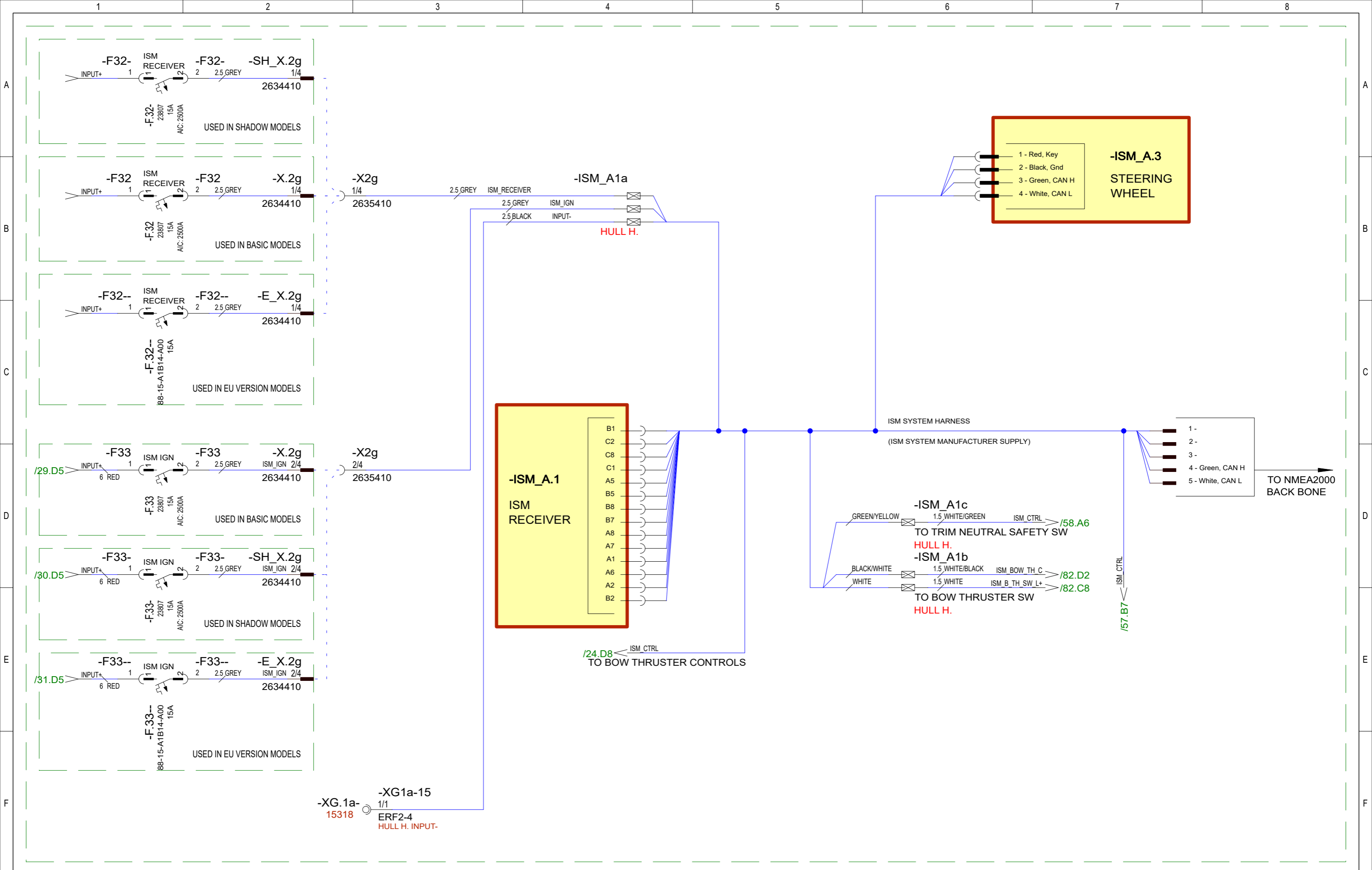

10.10.2023	PF	F22: 2004916; Not modified	Date	14.1.2019	NAVIX designed solutions	Axopar			
20.2.2024	PF	G23; 2005054; Not modified	Drawing by	TuM		Boat	37 MY20	Sub-product code	Product code
17.2.2023	RK	F21: NOT MODIFIED	Sheet rev.	23	Copyright by	Boat model	ISM SYSTEM - DIAGRAM	HL	56 / 213
Date of modification	Modified by	Description	Project rev.	G				Title	Loc

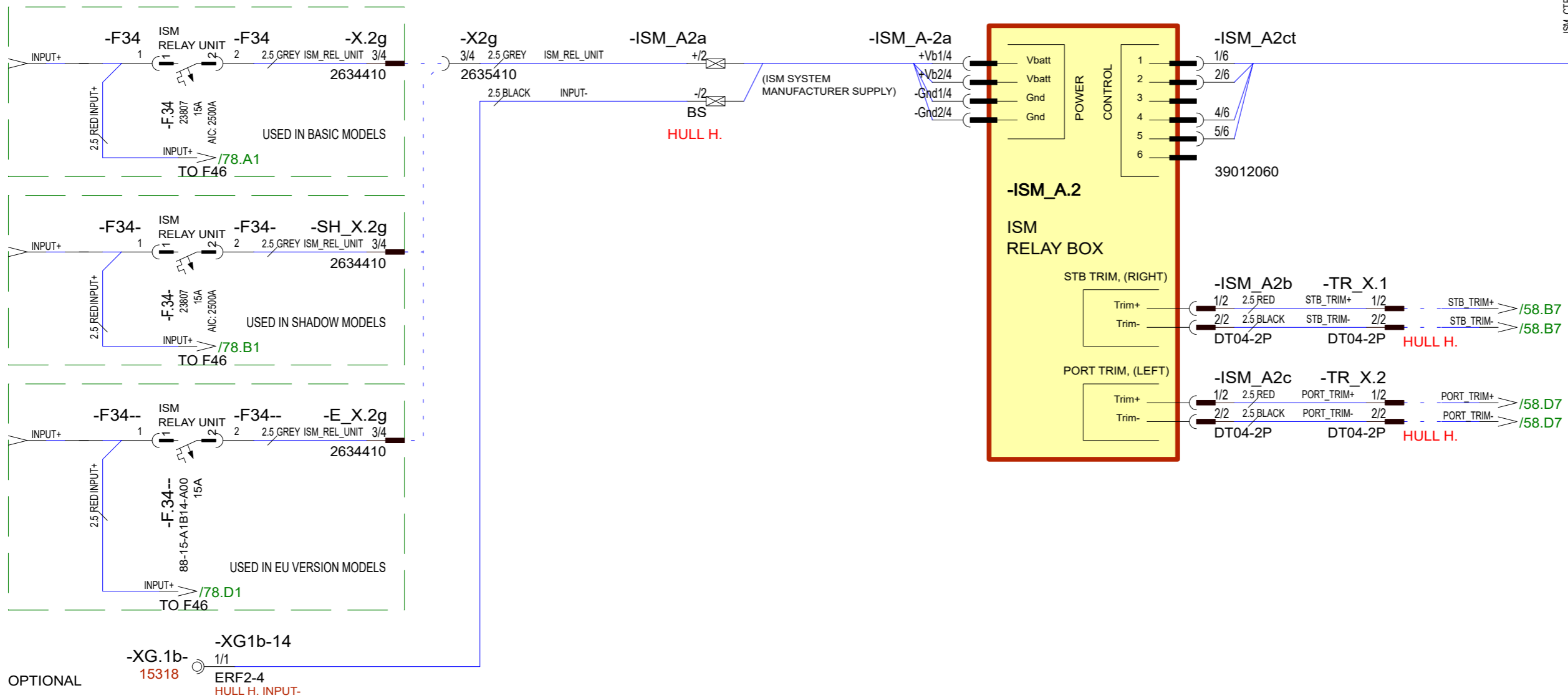

10.10.2023	PF	F22: 2004916; Not modified	Date	14.1.2021	 designed solutions	Axopar			
20.2.2024	PF	G23; 2005054; Not modified	Drawing by	TuM		Boat	37 MY20	Sub-product code	Product code
17.2.2023	RK	F21: NOT MODIFIED	Sheet rev.	23	Copyright by		ISM SYSTEM	HL	57 / 213
Date of modification	Modified by	Description	Project rev.	G		Boat model	- DIAGRAM	Loc	Sheet

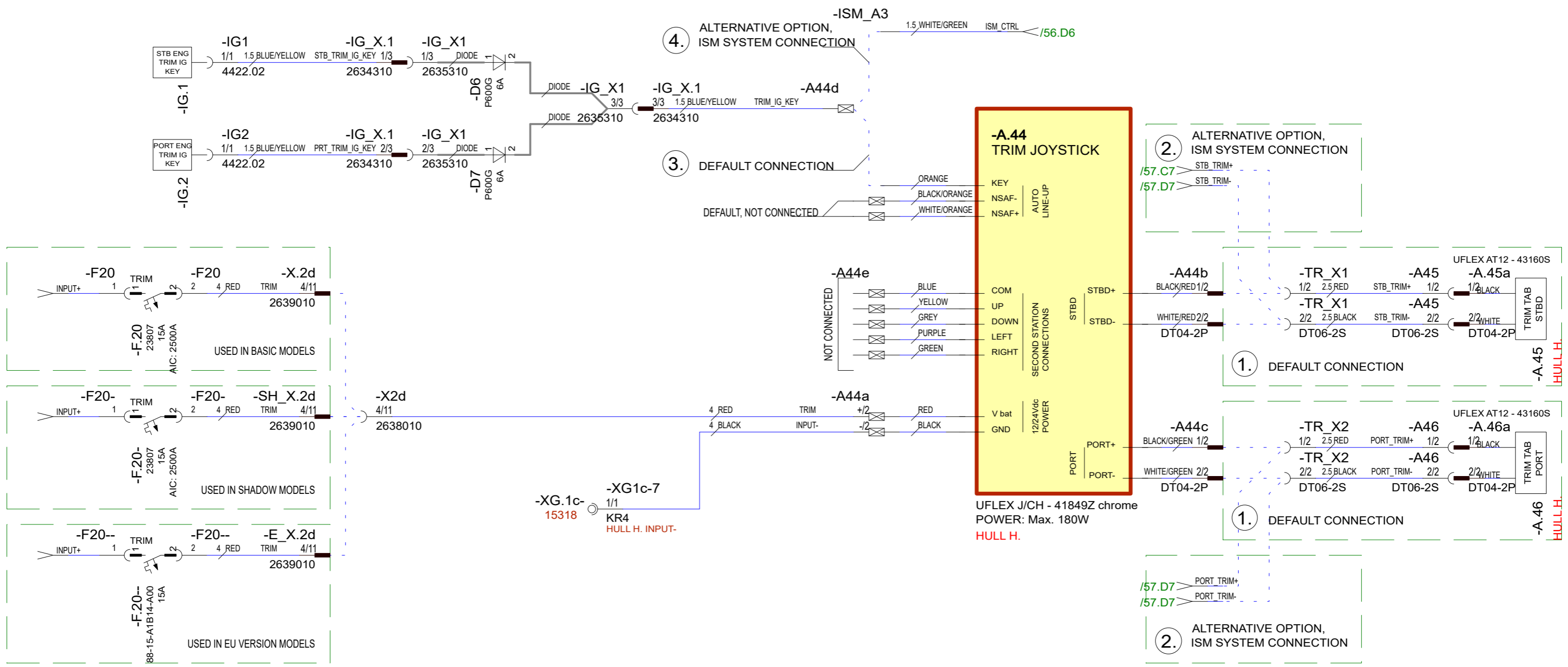

TRIM AUTO LINE-UP ALTERNATIVES:

- 3. ALTERNATIVE 1: DEFAULT CONNECTION. IGN KEY CONNECTED TO TRIM JOYSTICK: -A44d connected to -A.44/KEY
- 4. ALTERNATIVE 2: ISM SYSTEM CONNECTION. IGN KEY CONNECTED TO ISM CONTROL HARNESS: -A44d connected to -ISM_A3.

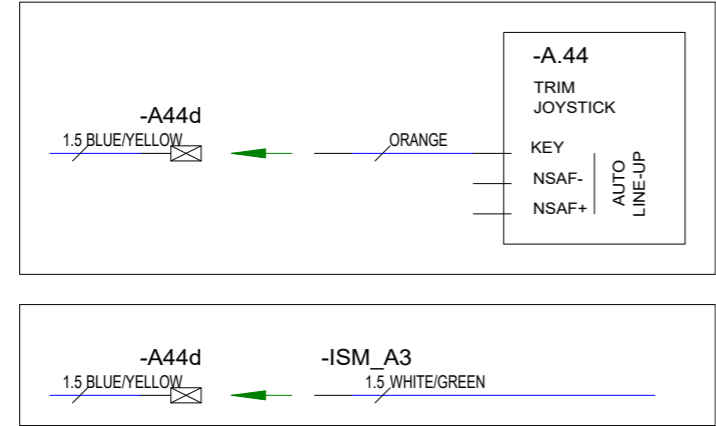

TRIM CONTROL ALTERNATIVES:

- 1. ALTERNATIVE 1: DEFAULT CONNECTION. TRIM TAB ARE CONNECTED TO TRIM JOYSTICK: -TR_X1 connected to -A44b, -TR_X2 connected to -A44c
- 2. ALTERNATIVE 2: ISM SYSTEM CONNECTION. TRIM TABS ARE CONNECTED TO ISM RELAY BOX: -TR_X1 connected to -TR_X.1, -TR_X2 connected to -TR_X.2

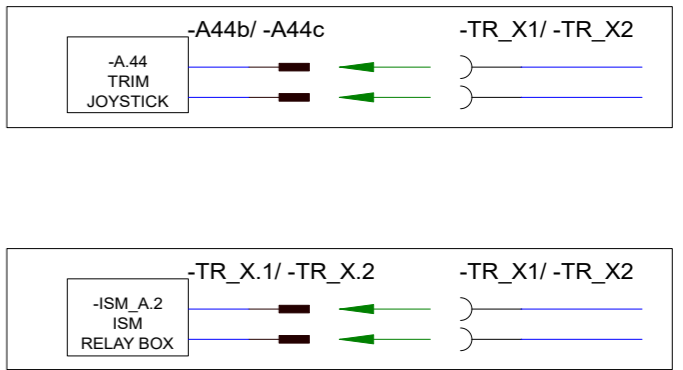

10.10.2023	PF	F22: 2004916; Not modified	Date	14.1.2019	NAVIX designed solutions	Axopar			
20.2.2024	PF	G23; 2005054; Not modified	Drawing by	TuM		Boat			
17.2.2023	RK	F21: NOT MODIFIED	Sheet rev.	23	Copyright by	37 MY20	Sub-product code	Product code	Project ID
Date of modification	Modified by	Description	Project rev.	G		Boat model	TRIM - DIAGRAM	HL	58 / 213
1	2	3	4	5	6	7	8	Loc	Sheet

OPTIONAL, FUSION ENTERTAINMENT SYSTEM

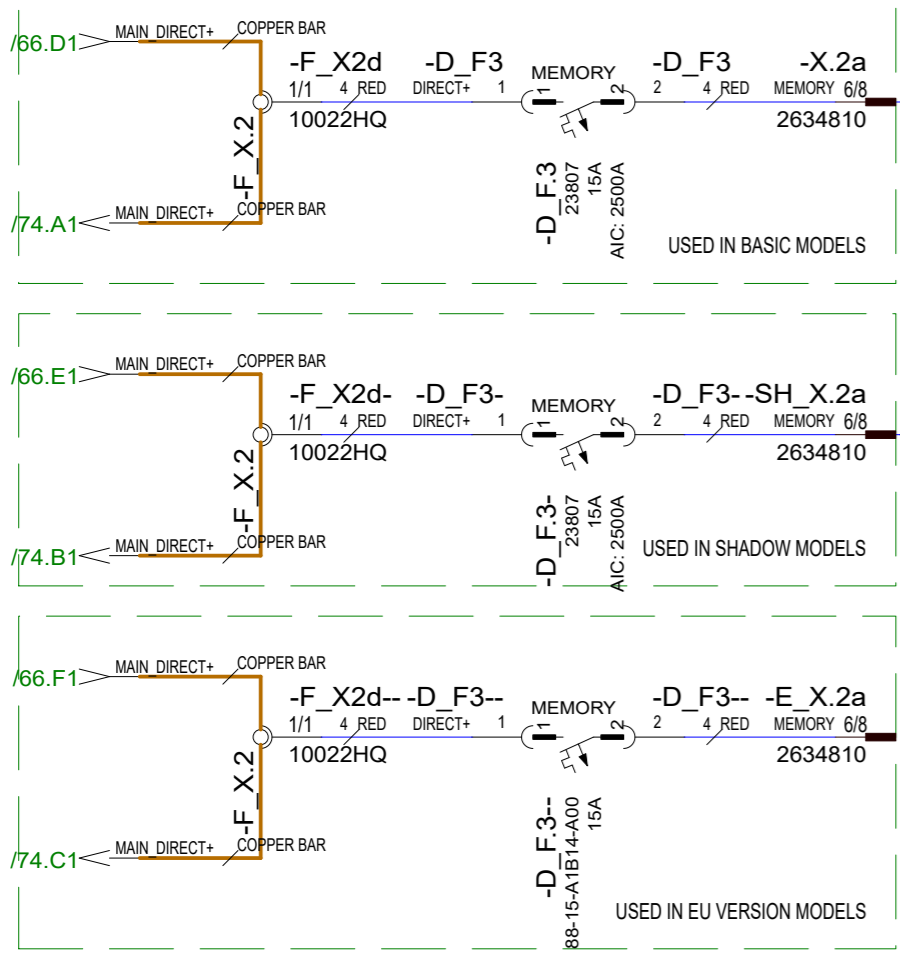
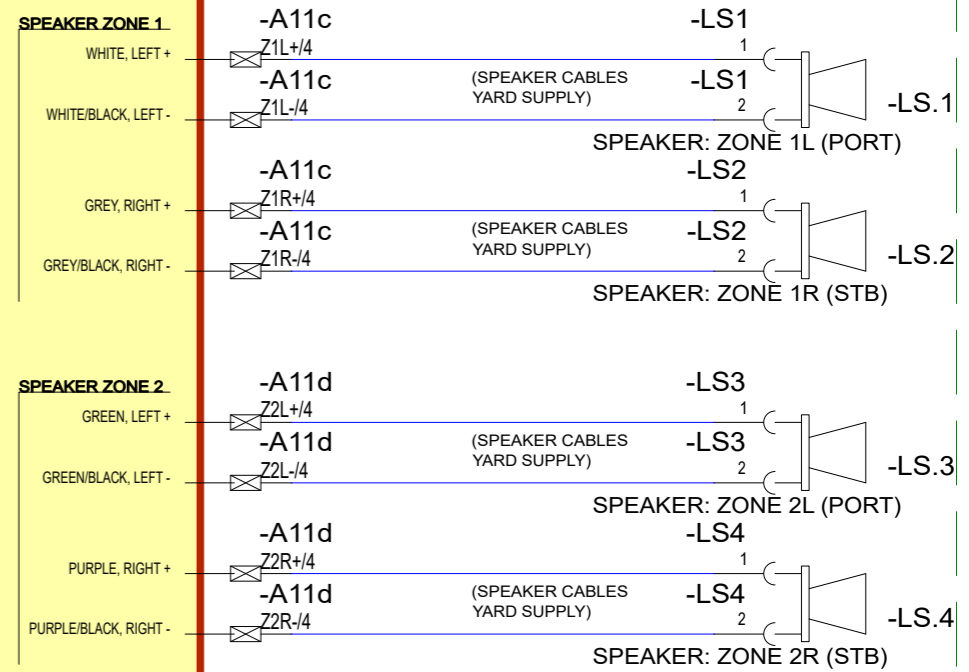
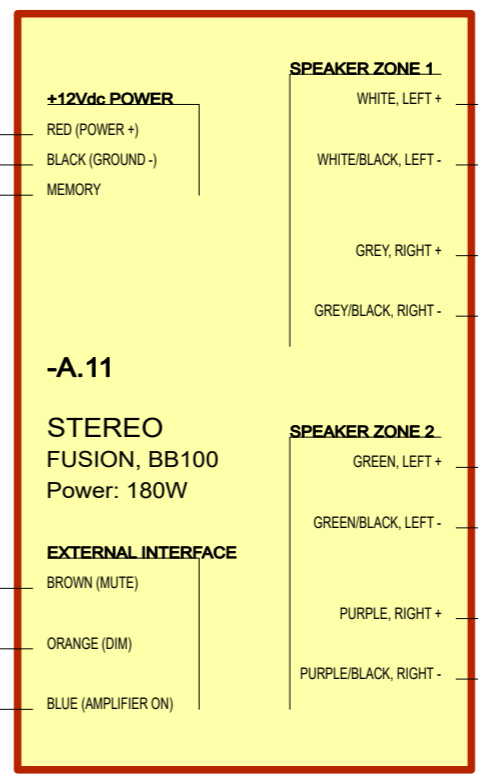
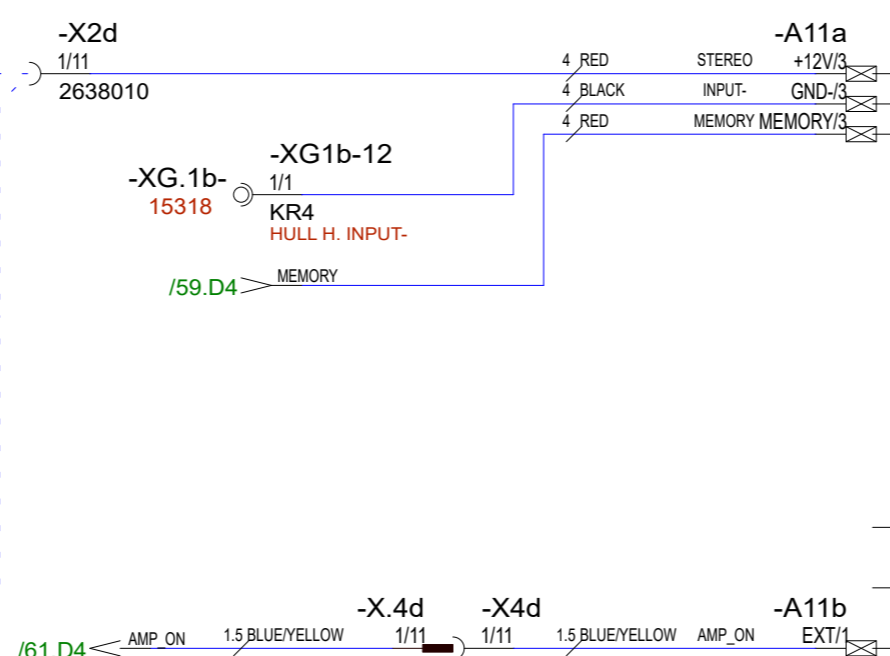
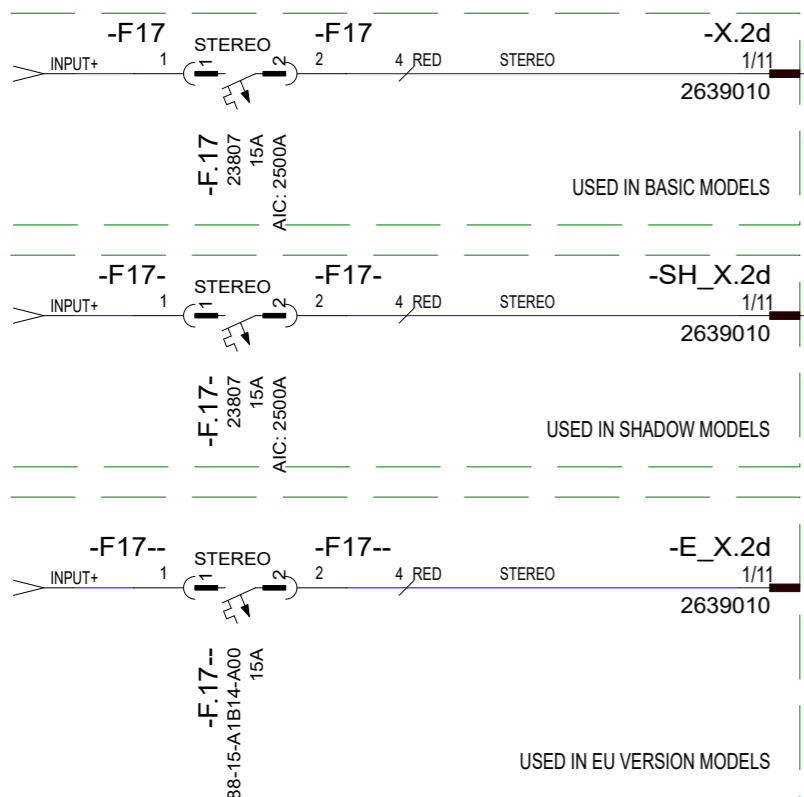

10.10.2023	PF	F22: 2004916; Not modified	Date	14.1.2019
20.2.2024	PF	G23; 2005054; Not modified	Drawing by	TuM
17.2.2023	RK	F21: NOT MODIFIED	Sheet rev.	23
Date of modification	Modified by	Description	Project rev.	G



Axopar	Boat	37 MY20	Boat model	Sub-product code	STEREO - DIAGRAM	Product code	HL	Project ID	59 / 213
				Title			Loc		Sheet

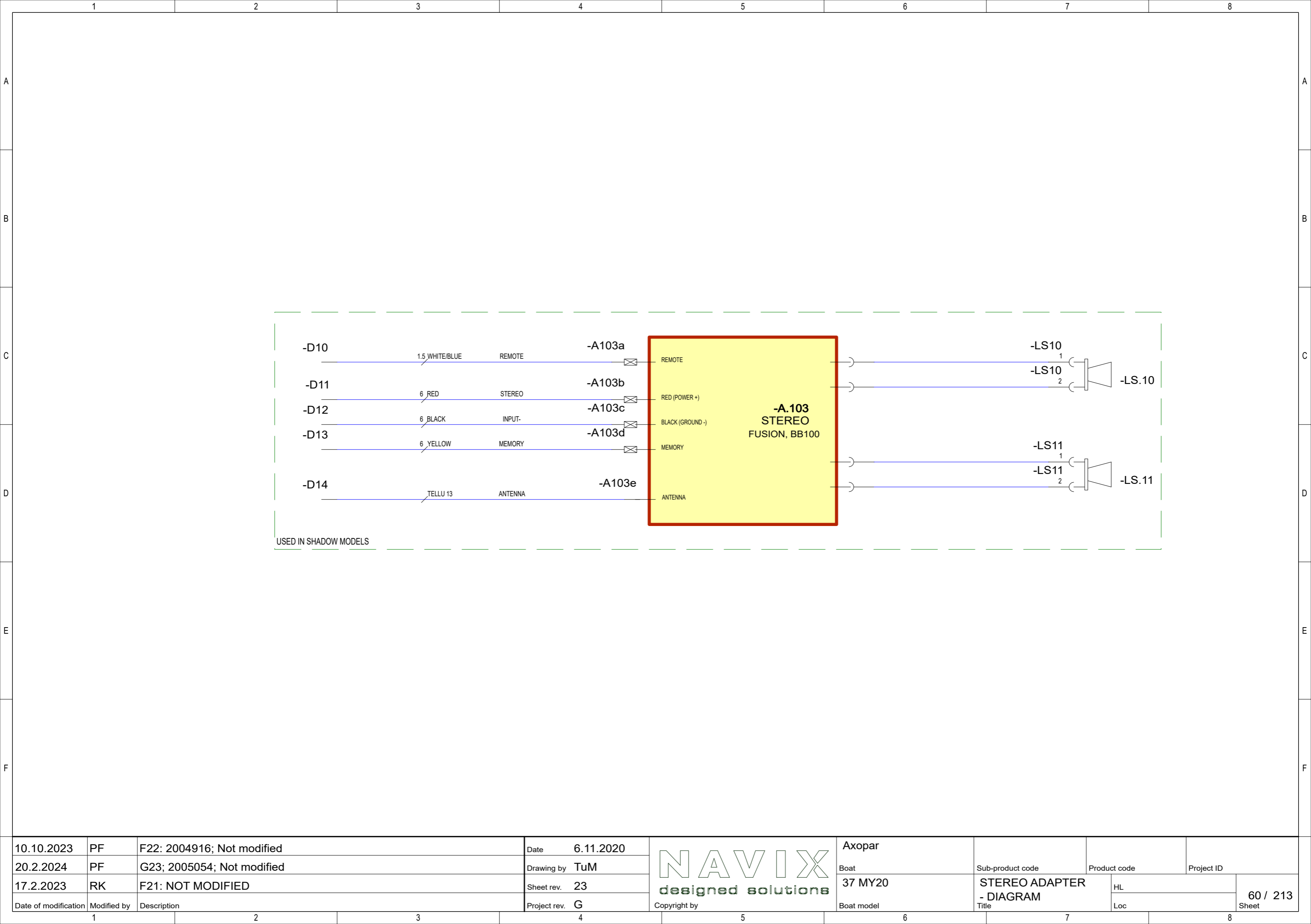

10.10.2023	PF	F22: 2004916; Not modified	Date	6.11.2020
20.2.2024	PF	G23; 2005054; Not modified	Drawing by	TuM
17.2.2023	RK	F21: NOT MODIFIED	Sheet rev.	23
Date of modification	Modified by	Description	Project rev.	G



Axopar			
Boat	37 MY20	Sub-product code	Product code
Boat model		STEREO ADAPTER - DIAGRAM	Project ID
		HL	60 / 213
		Loc	Sheet

OPTIONAL, AUDIO UPGRADE 2

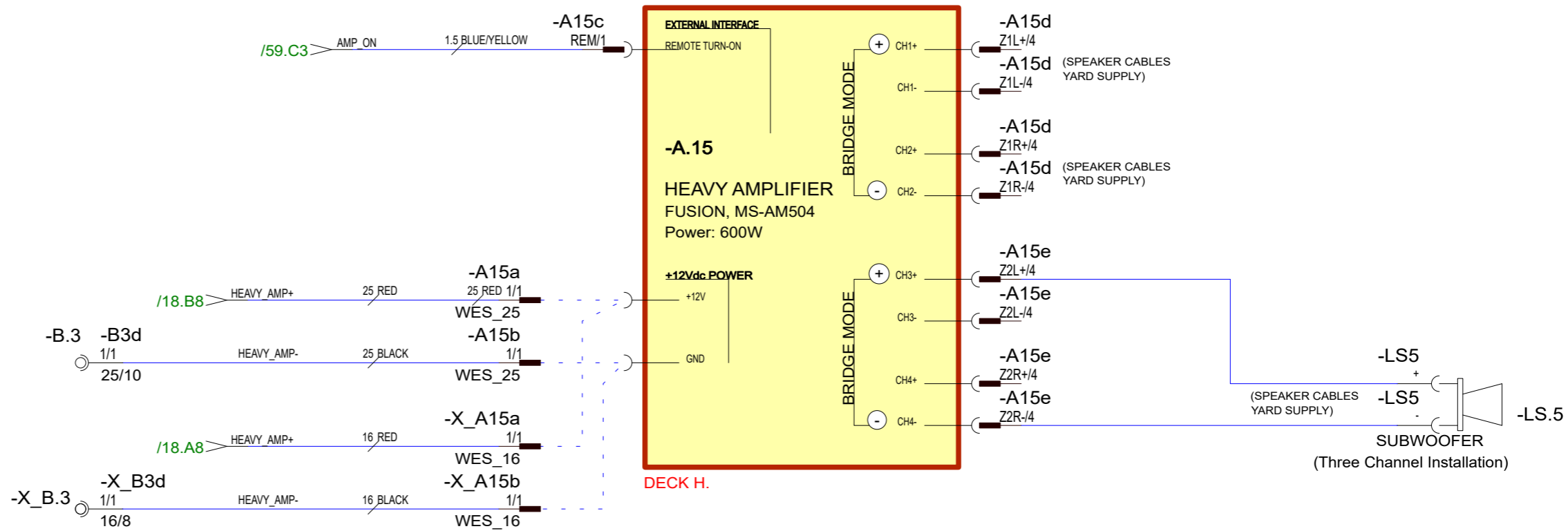

10.10.2023	PF	F22: 2004916; Not modified
20.2.2024	PF	G23; 2005054; Not modified
17.2.2023	RK	F21: NOT MODIFIED
Date of modification	Modified by	Description

Date	14.1.2019
Drawing by	TuM
Sheet rev.	23
Project rev.	G



Axopar
Boat
37 MY20
Boat model

Sub-product code	Product code	Project ID
HEAVY AMPLIFIER		HL
- DIAGRAM		Loc
Title		61/ 213
		Sheet

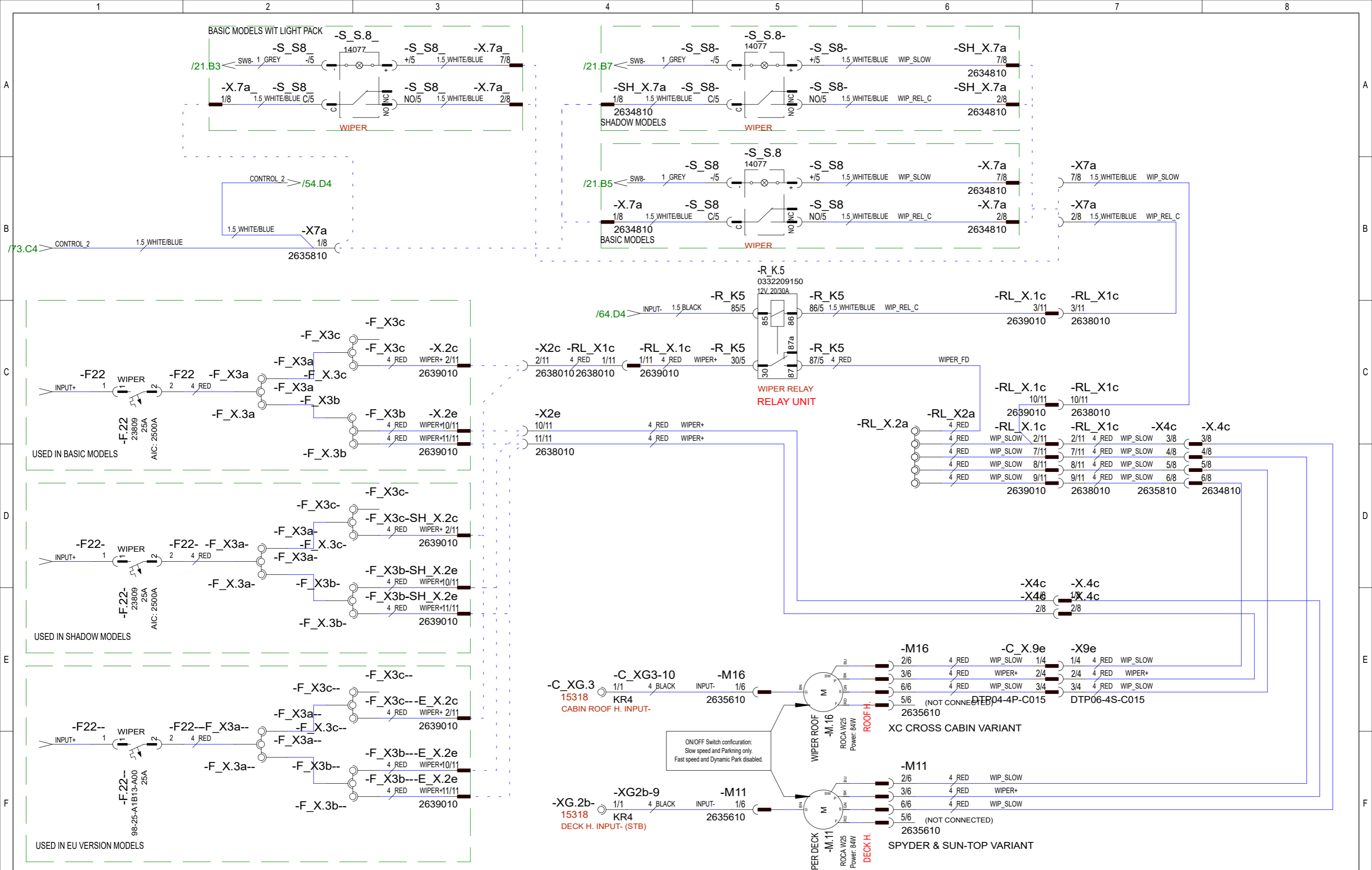



10.10.2023	PF	F22: 2004916; Not modified	Date	14.1.2019
20.2.2024	PF	G23; 2005054; -S_S.8_ added	Drawing by	TuM
17.2.2023	RK	F21: NOT MODIFIED	Sheet rev.	23
Date of modification	Modified by	Description	Project rev.	G

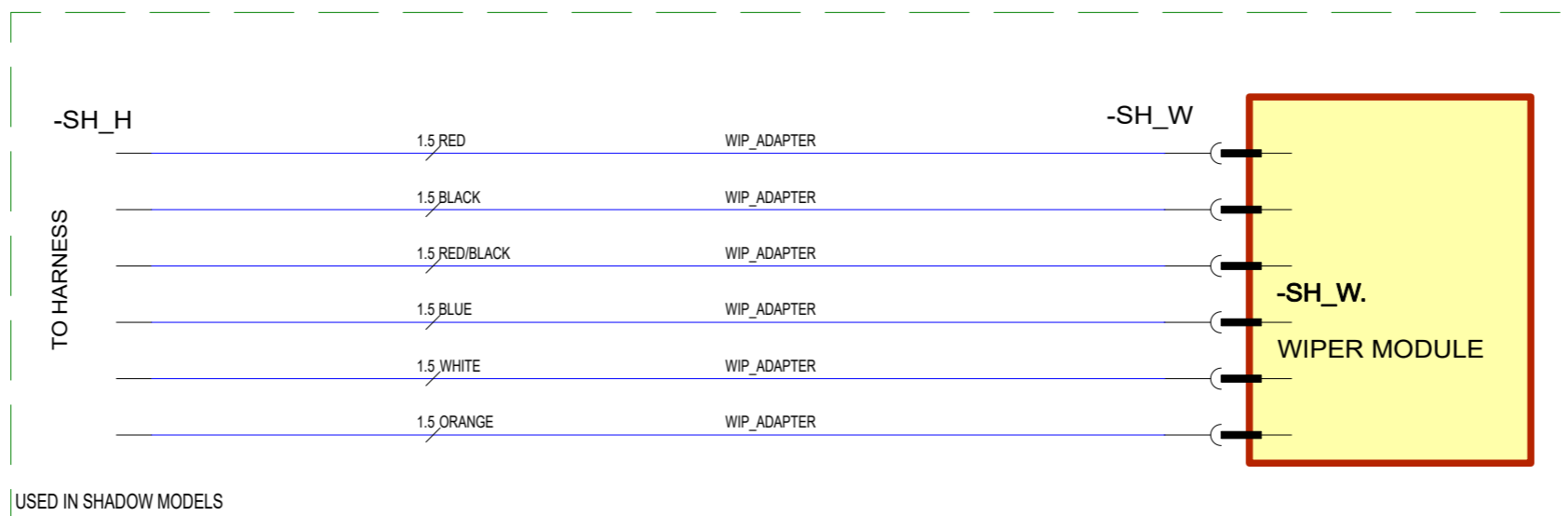

Axopar	Boat	37 MY20	Sub-product code	WIPERS	Product code	HL	Project ID	62 / 213
	Boat model		Title	- DIAGRAM		Loc		Sheet

	1	2	3	4	5	6	7	8
A								
B								
C								
D								
E								
F								



10.10.2023	PF	F22: 2004916; Not modified	Date	14.01.2019		Axopar			
20.2.2024	PF	G23; 2005054; Not modified	Drawing by	TuM		Boat	Sub-product code	Product code	Project ID
17.2.2023	RK	F21: NOT MODIFIED	Sheet rev.	23		37 MY20	WIPER ADAPTER	HL	63 / 213
Date of modification	Modified by	Description	Project rev.	G	Boat model	- DIAGRAM	Loc	Sheet	

	1	2	3	4	5	6	7	8
--	---	---	---	---	---	---	---	---

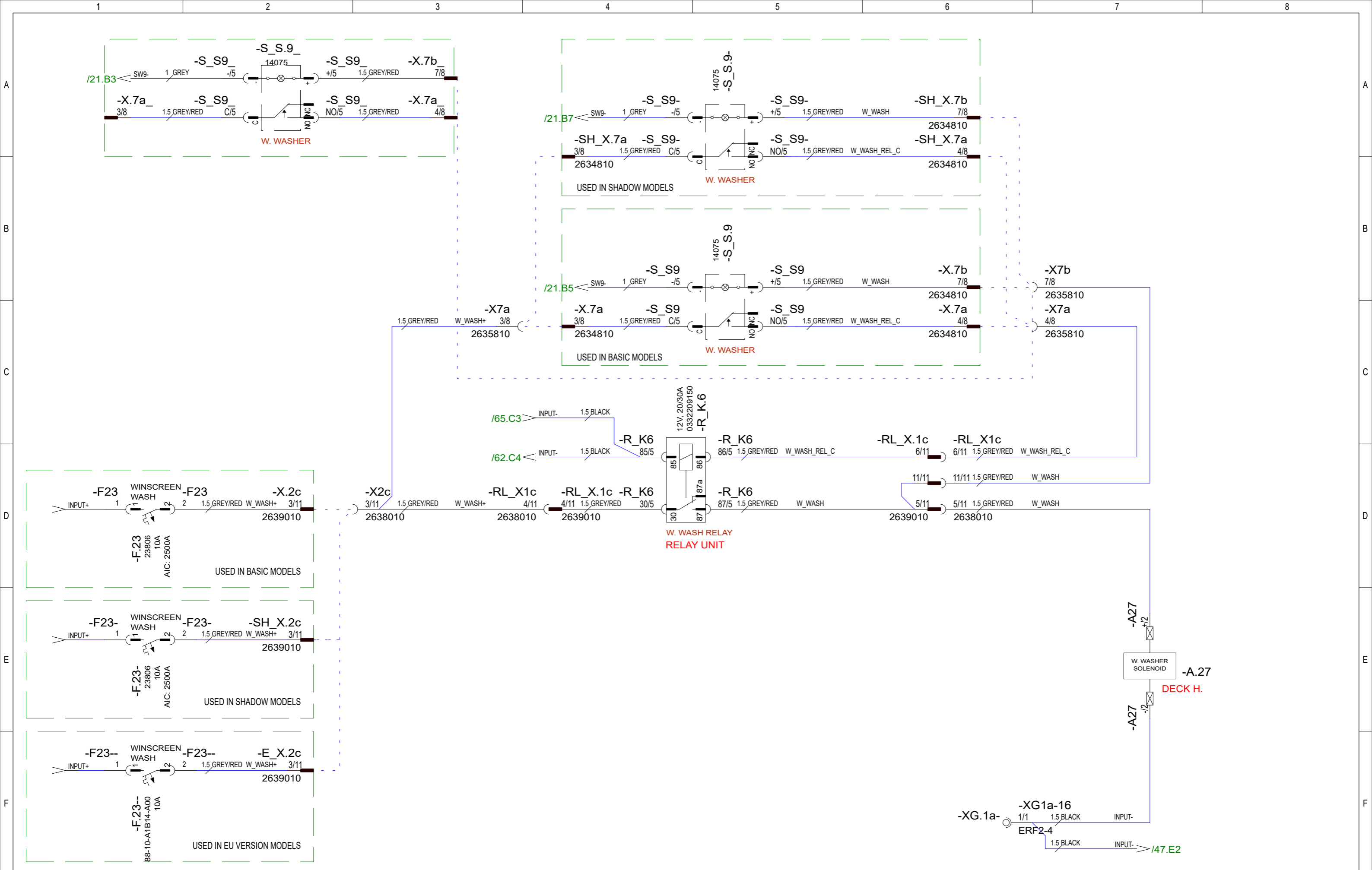

10.10.2023	PF	F22: 2004916; Not modified	Date	14.1.2019
20.2.2024	PF	G23; 2005054; -S_S.9_ added	Drawing by	TuM
17.2.2023	RK	F21: NOT MODIFIED	Sheet rev.	23
Date of modification	Modified by	Description	Project rev.	G

Copyright by

Axopar

Boat: 37 MY20

Boat model:

Sub-product code: WINDSCREEN WASH - DIAGRAM

Product code: HL

Project ID: 64 / 213

Loc: Sheet

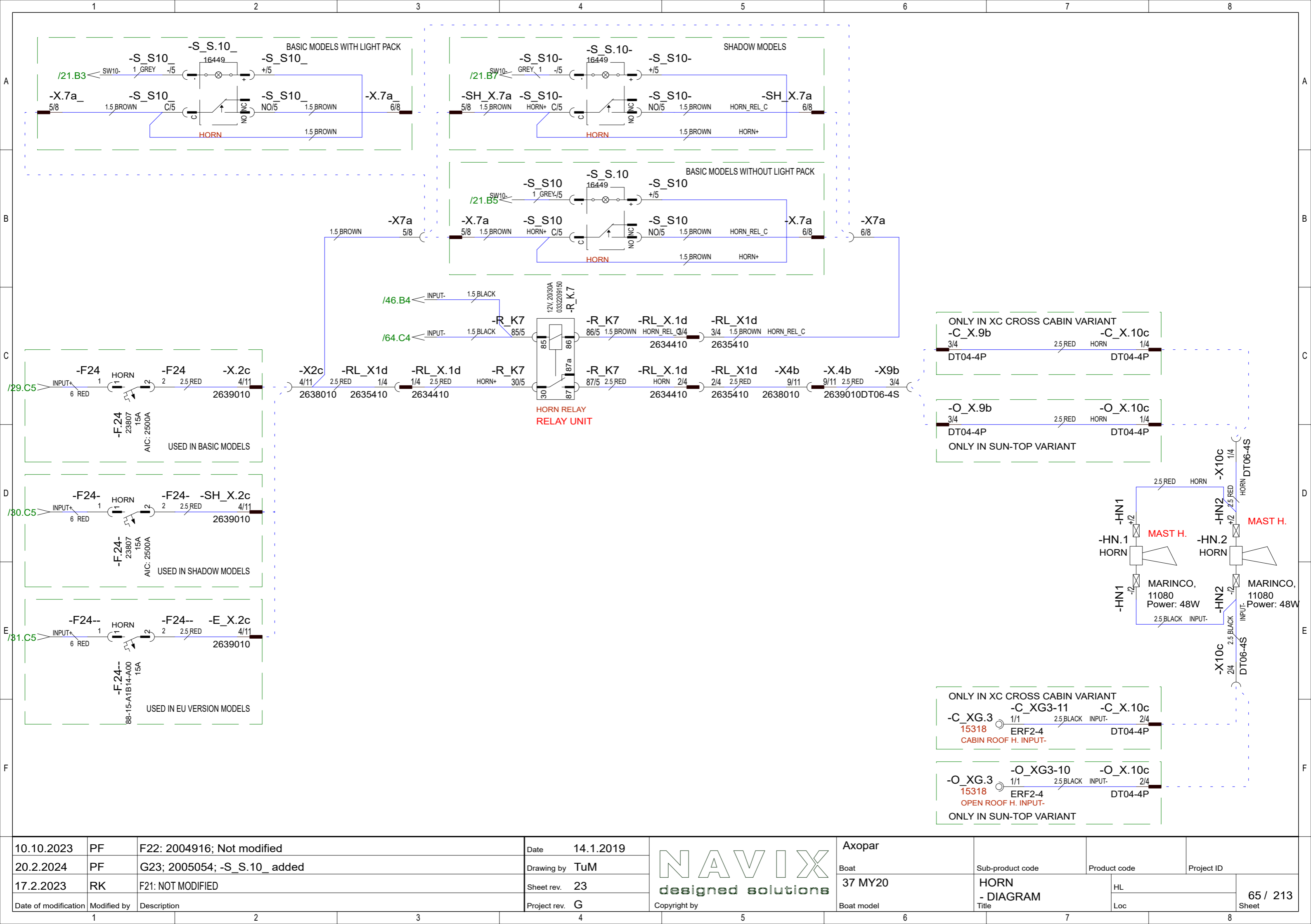

10.10.2023	PF	F22: 2004916; Not modified	Date	14.1.2019
20.2.2024	PF	G23; 2005054; -S_S.10_ added	Drawing by	TuM
17.2.2023	RK	F21: NOT MODIFIED	Sheet rev.	23
Date of modification	Modified by	Description	Project rev.	G



Axopar				
Boat	37 MY20	Sub-product code	Product code	Project ID
Boat model		HORN - DIAGRAM	HL	65 / 213
		Title	Loc	Sheet

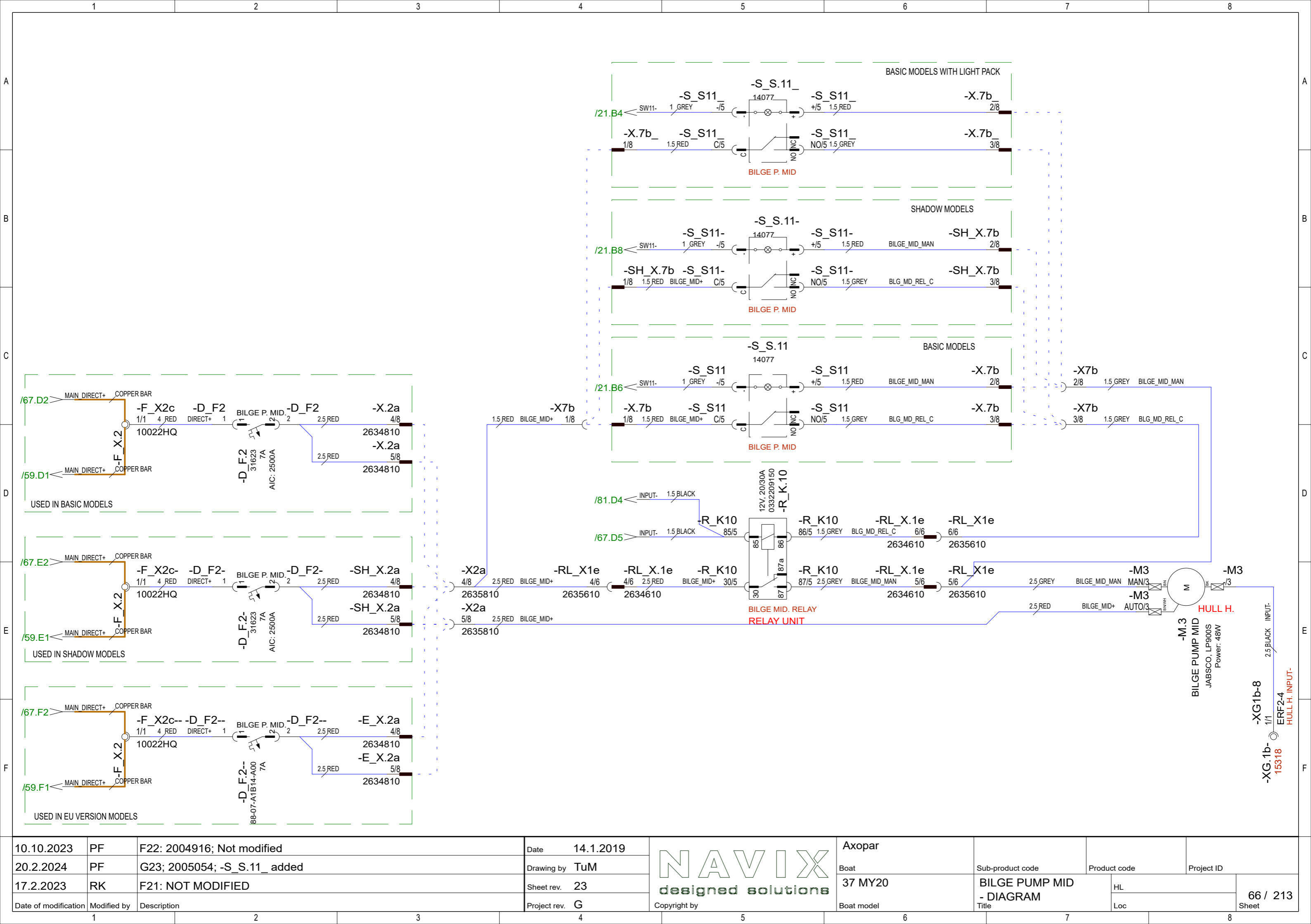

10.10.2023	PF	F22: 2004916; Not modified	Date	14.1.2019
20.2.2024	PF	G23; 2005054; -S_S.11_ added	Drawing by	TuM
17.2.2023	RK	F21: NOT MODIFIED	Sheet rev.	23
Date of modification	Modified by	Description	Project rev.	G



Axopar	Boat	Sub-product code	Product code	Project ID
37 MY20	37 MY20	BILGE PUMP MID	HL	66 / 213
Boat model	Title	Loc	Sheet	

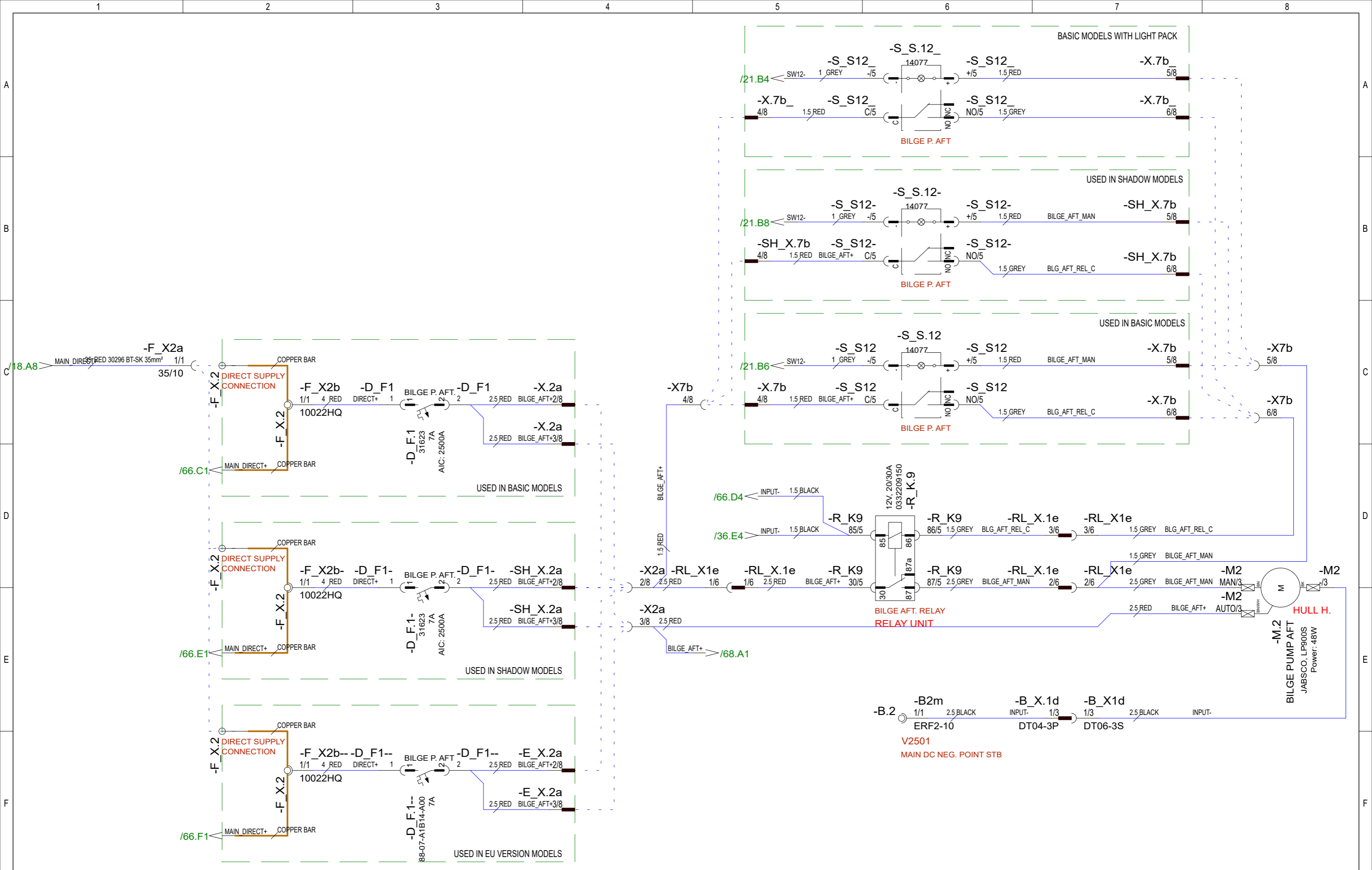

10.10.2023	PF	F22: 2004916; Not modified	Date	14.1.2019
20.2.2024	PF	G23; 2005054; -S_S.12_ added	Drawing by	TuM
17.2.2023	RK	F21: NOT MODIFIED	Sheet rev.	23
Date of modification	Modified by	Description	Project rev.	G



Axopar			
Boat	37 MY20	Sub-product code	Product code
Boat model		BILGE PUMP AFT - DIAGRAM	
		HL	Project ID
		Loc	67 / 213
			Sheet

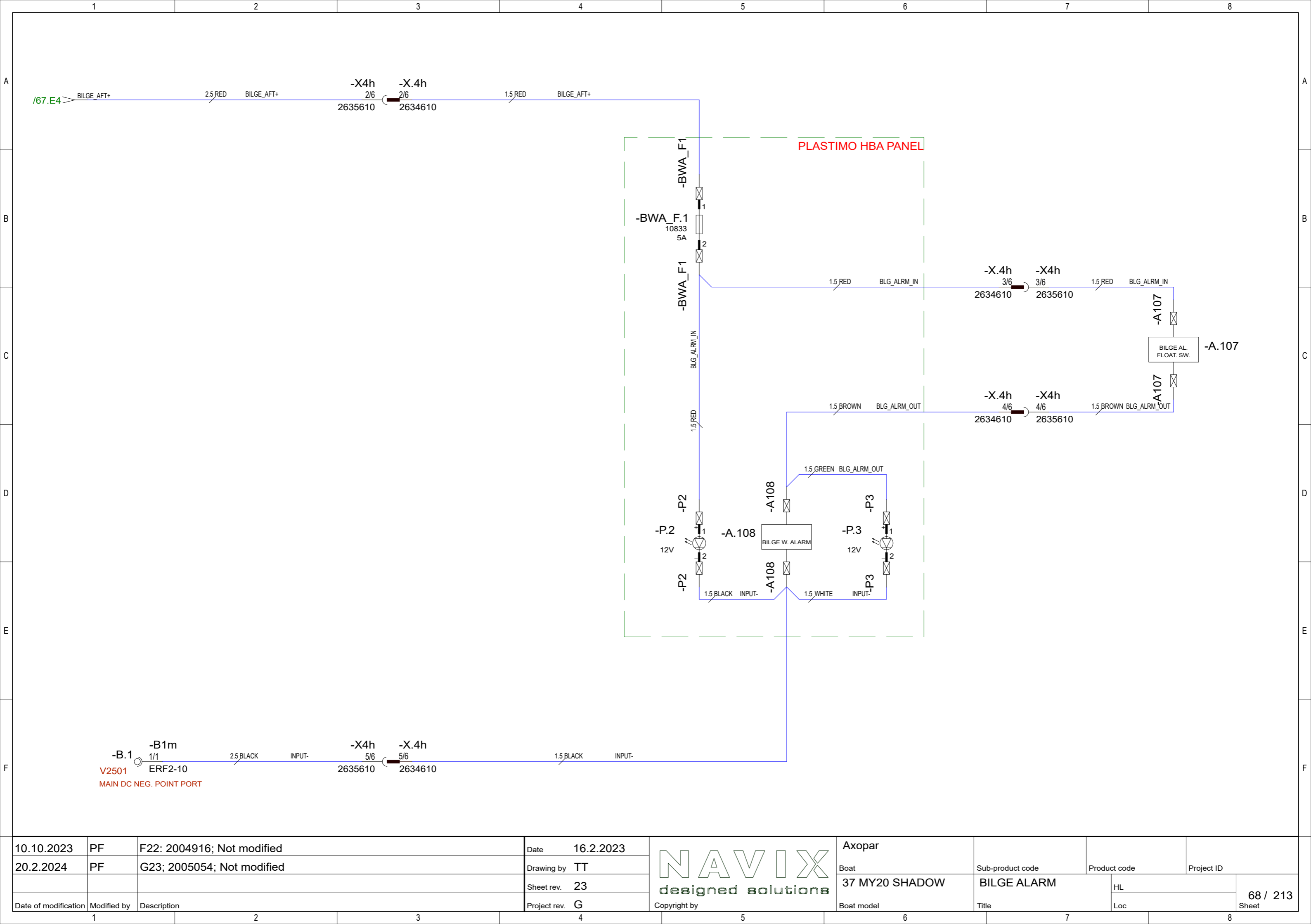

10.10.2023	PF	F22; 2004916; Not modified	Date	16.2.2023
20.2.2024	PF	G23; 2005054; Not modified	Drawing by	TT
			Sheet rev.	23
Date of modification	Modified by	Description	Project rev.	G



Axopar			
Boat	37 MY20 SHADOW	Sub-product code	Product code
Boat model		BILGE ALARM	Project ID
		HL	68 / 213
		Loc	Sheet

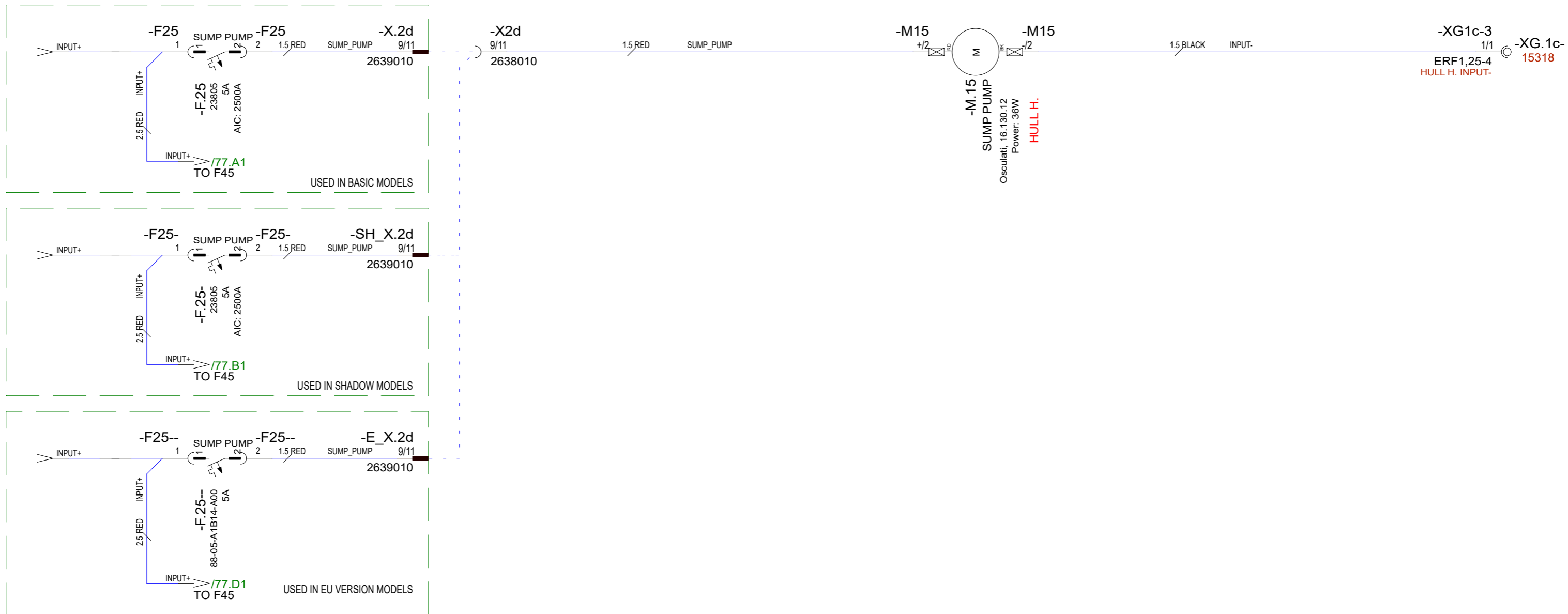

10.10.2023	PF	F22: 2004916; Not modified	Date	14.1.2019
20.2.2024	PF	G23; 2005054; Not modified	Drawing by	TuM
17.2.2023	RK	F21: NOT MODIFIED	Sheet rev.	23
Date of modification	Modified by	Description	Project rev.	G



Axopar			
Boat	Sub-product code	Product code	Project ID
37 MY20	PUMPS - DIAGRAM	HL	69 / 213
Boat model	Title	Loc	Sheet

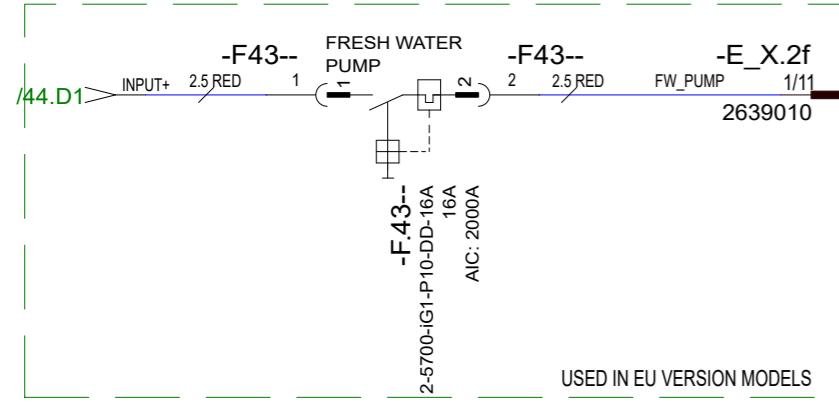
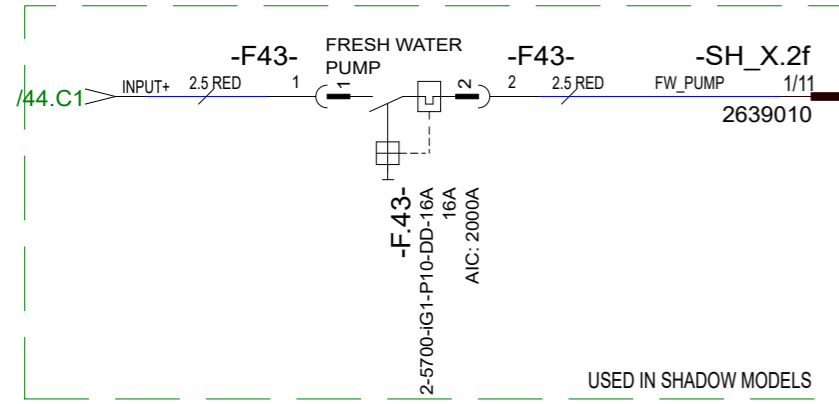
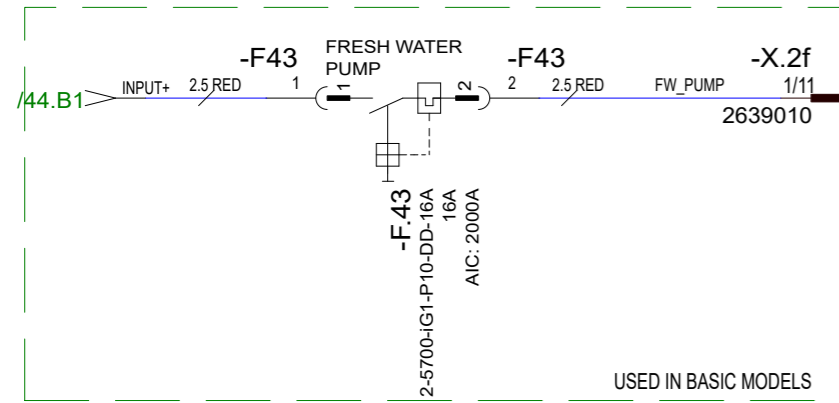
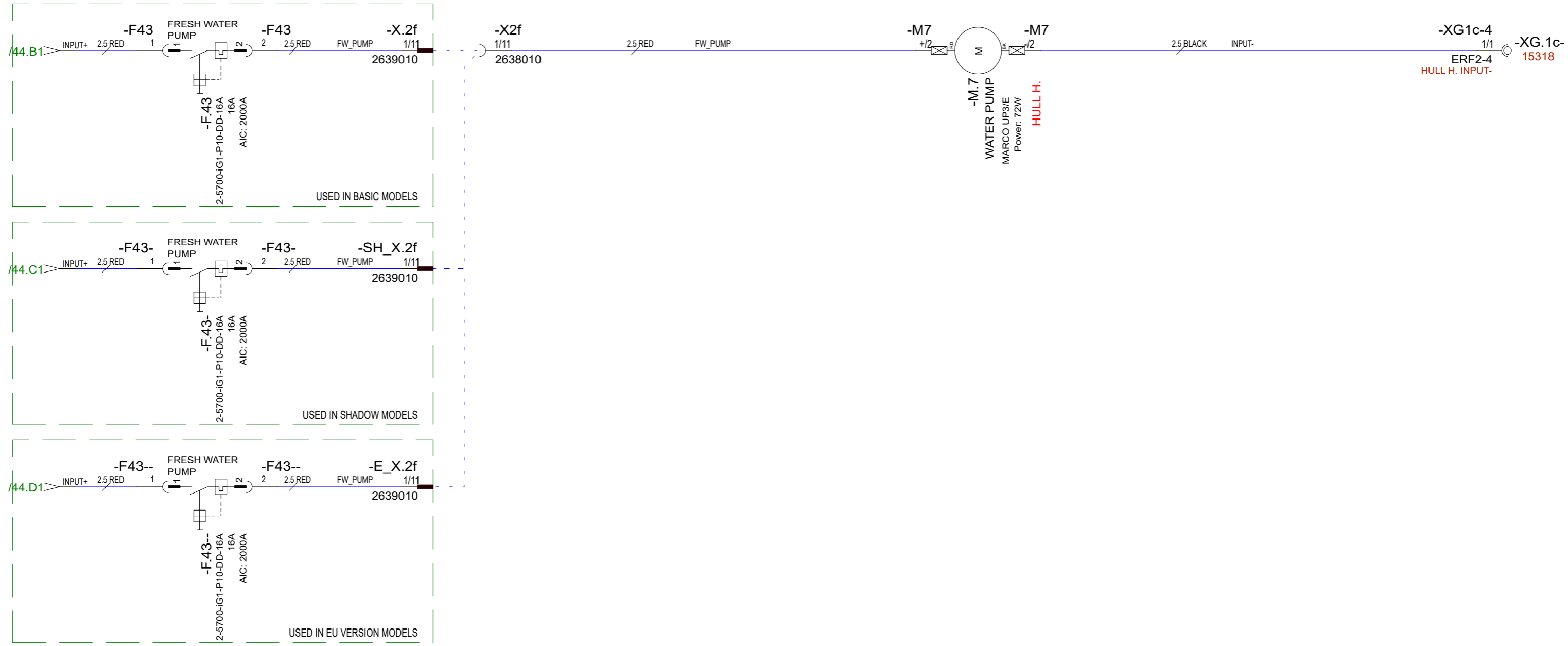

10.10.2023	PF	F22: 2004916; Not modified	Date	14.1.2019	NAVIX designed solutions	Axopar			
20.2.2024	PF	G23; 2005054; Not modified	Drawing by	TuM		Boat	Sub-product code	Product code	Project ID
17.2.2023	RK	F21: NOT MODIFIED	Sheet rev.	23	Copyright by	37 MY20	PUMPS - DIAGRAM		HL
Date of modification	Modified by	Description	Project rev.	G		Boat model	Title	Loc	70 / 213 Sheet

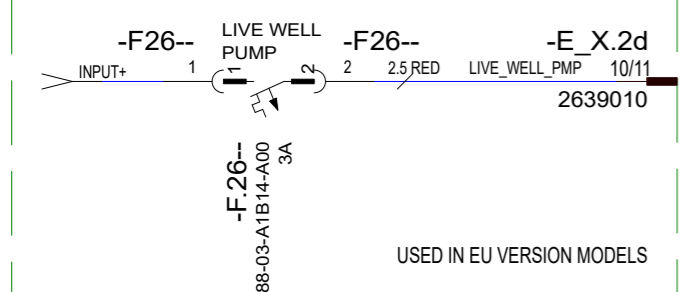
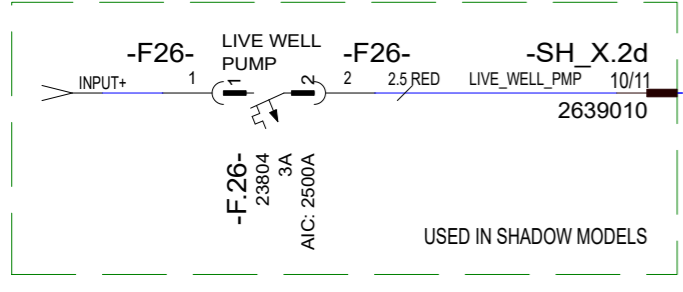
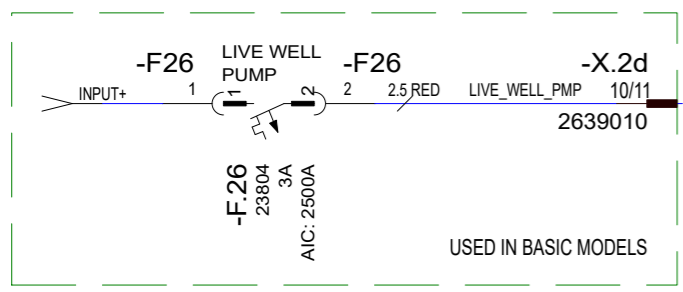
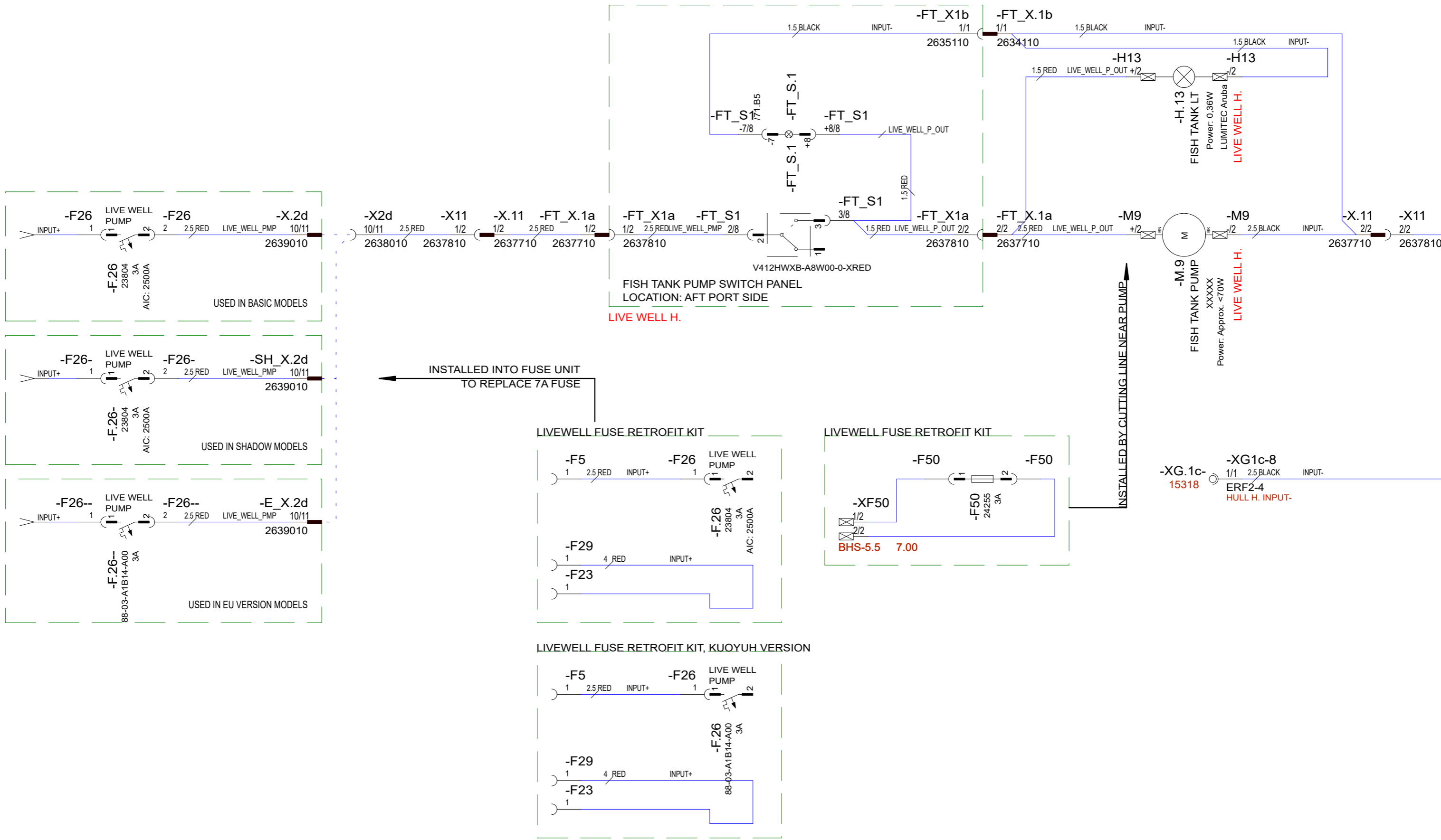

← INSTALLED INTO FUSE UNIT
TO REPLACE 7A FUSE

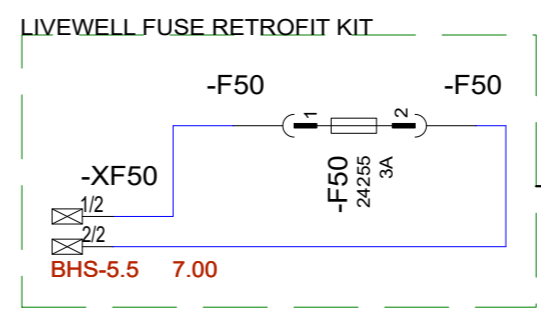
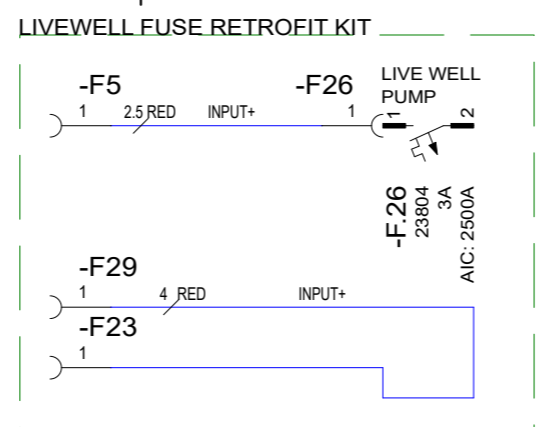

↑ INSTALLED BY CUTTING LINE NEAR PUMP

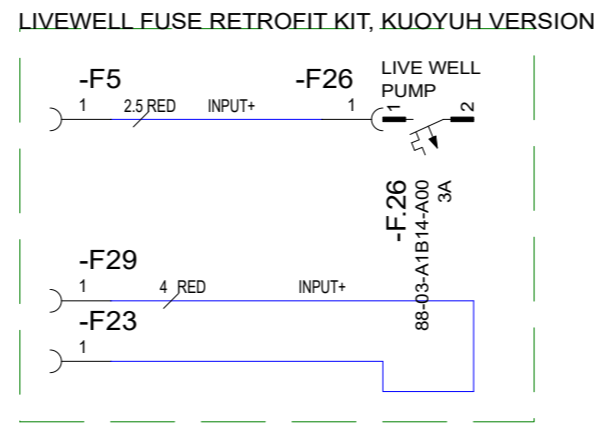

10.10.2023	PF	F22: 2004916; Not modified, 2004954; Livewell fuse to 3A+retrofit version	Date	14.1.2019
20.2.2024	PF	G23; 2005054; Not modified	Drawing by	TuM
17.2.2023	RK	F21: NOT MODIFIED	Sheet rev.	23
Date of modification	Modified by	Description	Project rev.	G



Axopar				
Boat	37 MY20	Sub-product code	Product code	Project ID
Boat model		LIVE WELL PUMP - DIAGRAM	HL	71/ 213
		Title	Loc	Sheet

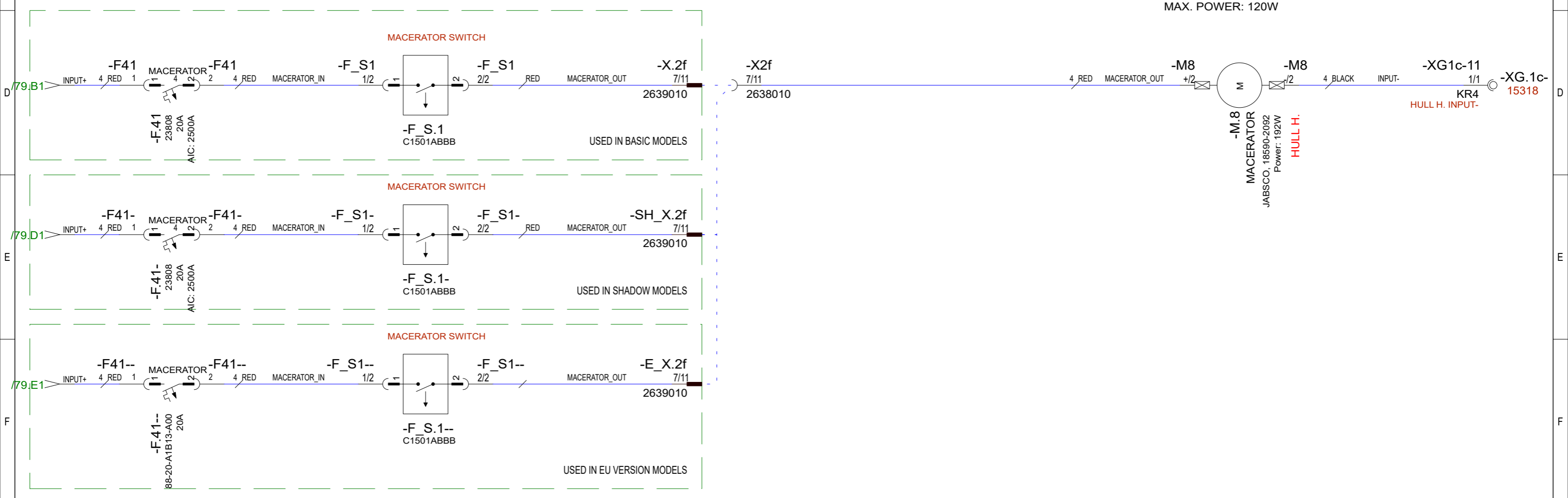
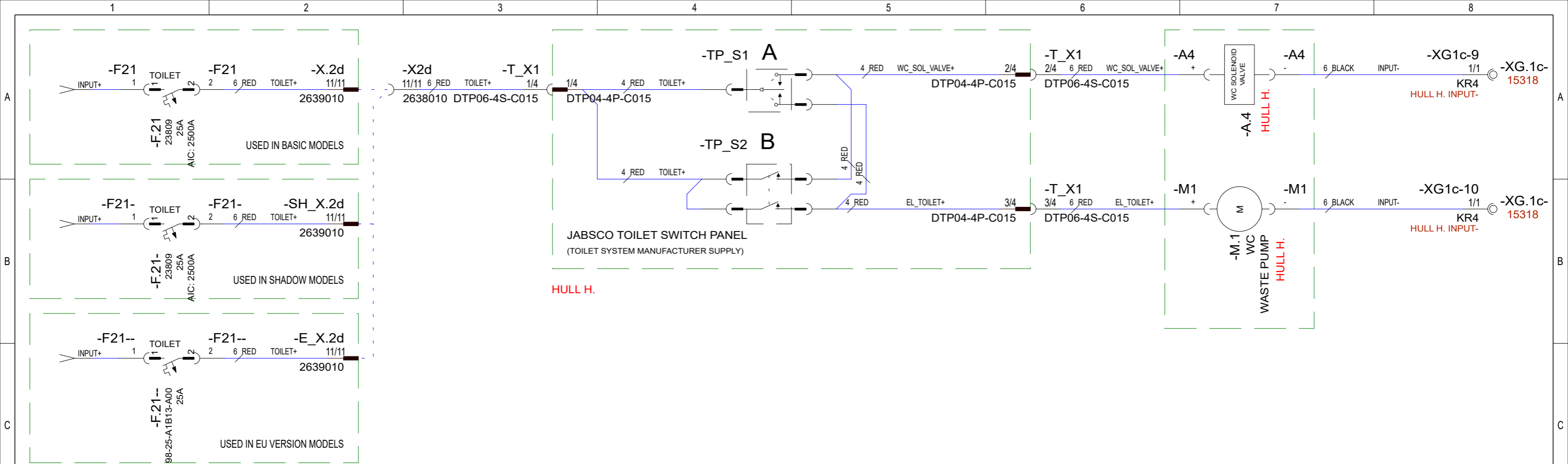

MAX. POWER: 120W

10.10.2023	PF	F22: 2004916; Not modified	Date	14.1.2021	NAVIX designed solutions	Axopar			
20.2.2024	PF	G23; 2005054; Not modified	Drawing by	TuM		Boat			
17.2.2023	RK	F21: NOT MODIFIED	Sheet rev.	23	Copyright by	37 MY20	TOILET/ MACERATOR/ WASTE TANK SNS - DIAGRAM	HL Loc	72 / 213
Date of modification	Modified by	Description	Project rev.	G		Boat model	Title	Loc	Sheet

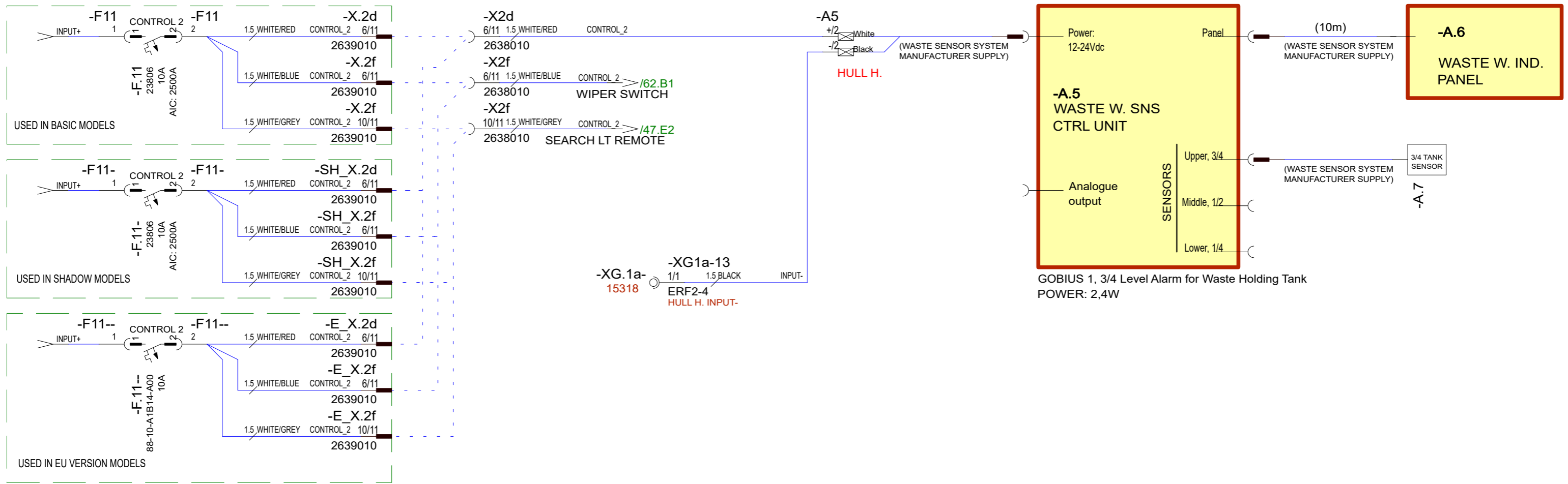

10.10.2023	PF	F22: 2004916; Not modified	Date	14.1.2019
20.2.2024	PF	G23; 2005054; Not modified	Drawing by	TuM
17.2.2023	RK	F21: NOT MODIFIED	Sheet rev.	23
Date of modification	Modified by	Description	Project rev.	G



Axopar			
Boat	37 MY20	Sub-product code	Product code
Boat model		Title	Project ID
		TOILET/ MACERATOR/ WASTE TANK SNS - DIAGRAM	HL Loc
			73 / 213 Sheet

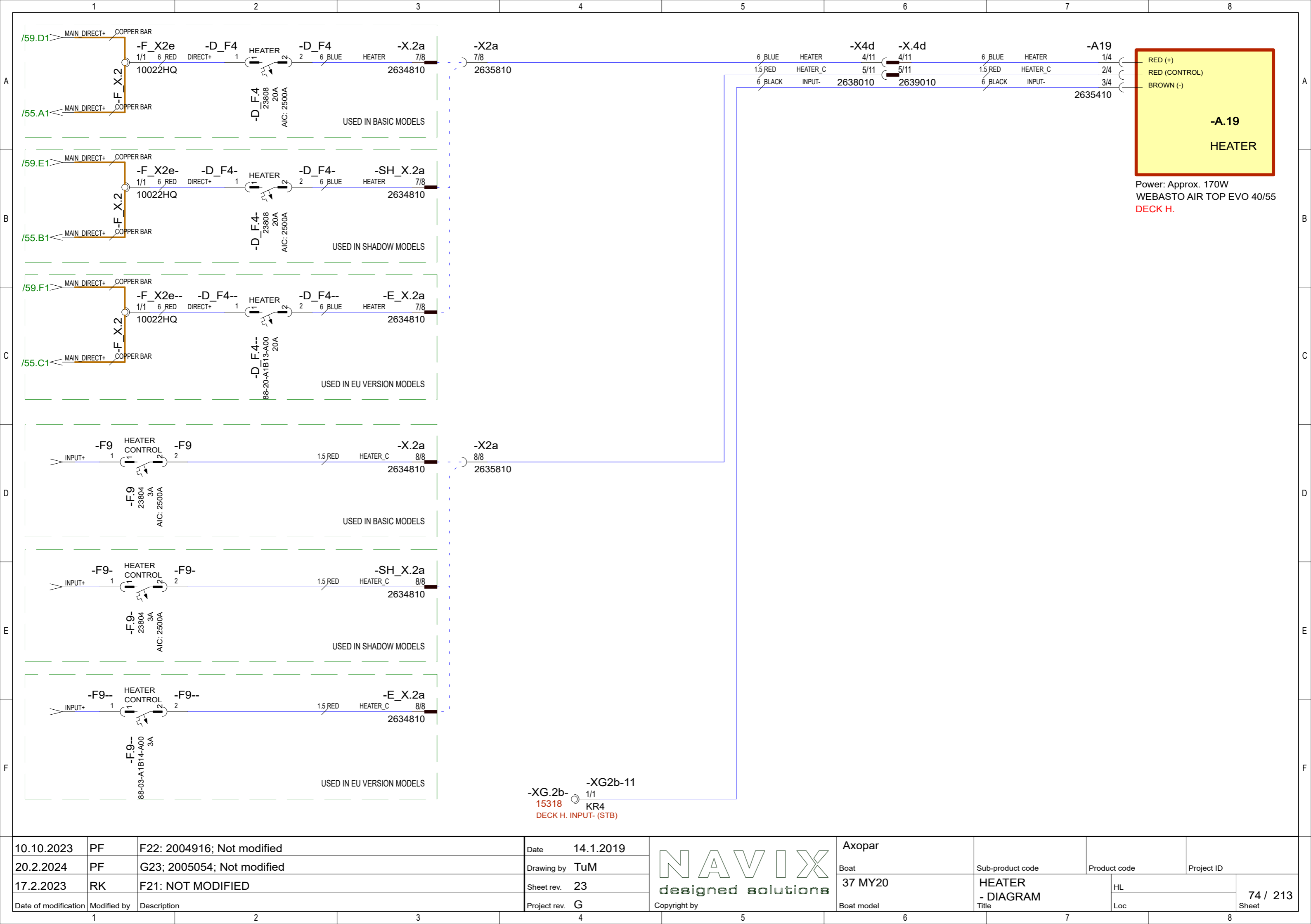

10.10.2023	PF	F22: 2004916; Not modified
20.2.2024	PF	G23; 2005054; Not modified
17.2.2023	RK	F21: NOT MODIFIED
Date of modification	Modified by	Description

Date	14.1.2019
Drawing by	TuM
Sheet rev.	23
Project rev.	G



Axopar			
Boat	37 MY20	Sub-product code	Product code
Boat model		HEATER - DIAGRAM	Project ID
		HL	74 / 213
		Loc	Sheet

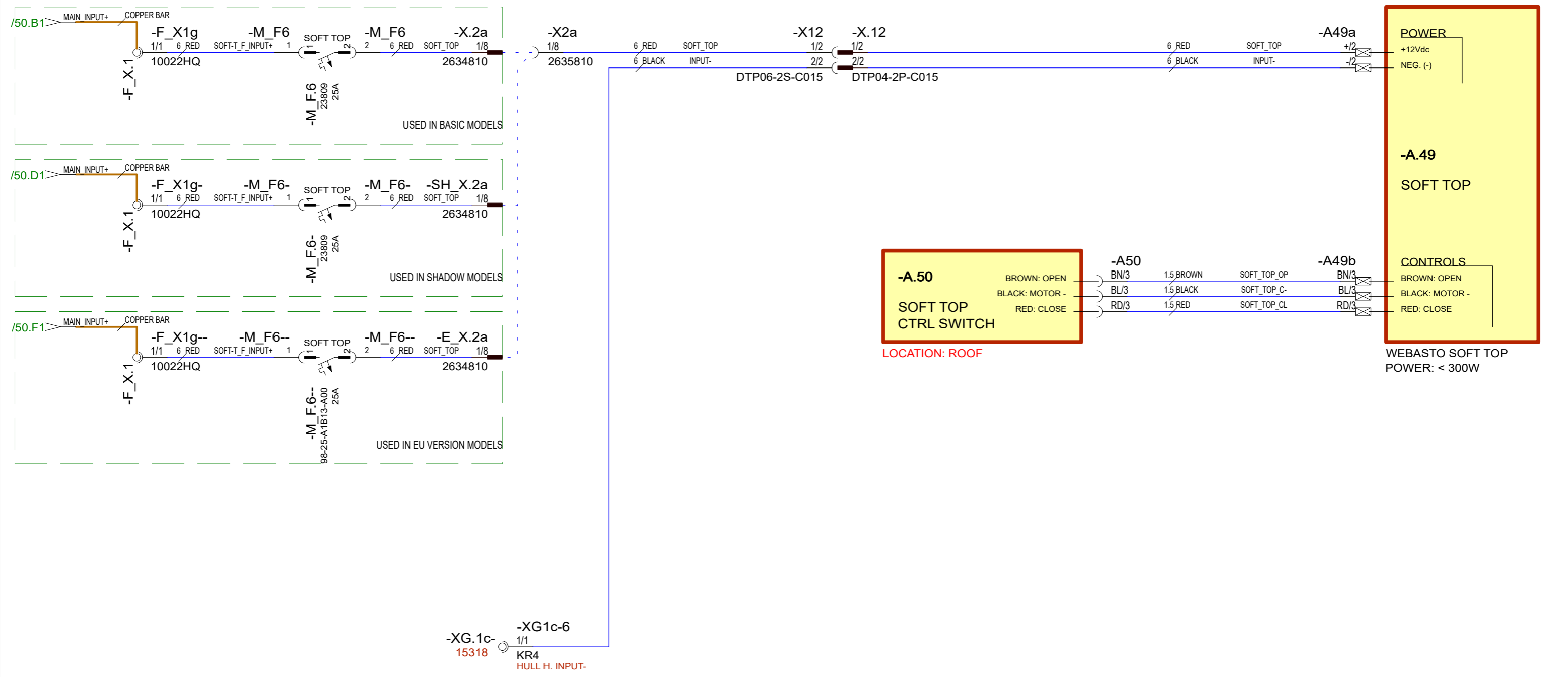

-A.50
SOFT TOP CTRL SWITCH

BROWN: OPEN
 BLACK: MOTOR -
 RED: CLOSE

LOCATION: ROOF

POWER
 +12Vdc
 NEG. (-)

-A.49
SOFT TOP

CONTROLS
 BROWN: OPEN
 BLACK: MOTOR -
 RED: CLOSE

WEBASTO SOFT TOP
 POWER: < 300W

10.10.2023	PF	F22: 2004916; Not modified	Date	5.4.2019
20.2.2024	PF	G23; 2005054; Not modified	Drawing by	TuM
17.2.2023	RK	F21: NOT MODIFIED	Sheet rev.	23
Date of modification	Modified by	Description	Project rev.	G



Axopar			
Boat	37 MY20	Sub-product code	Product code
Boat model		Title	Project ID
		HL	75 / 213
		Loc	Sheet

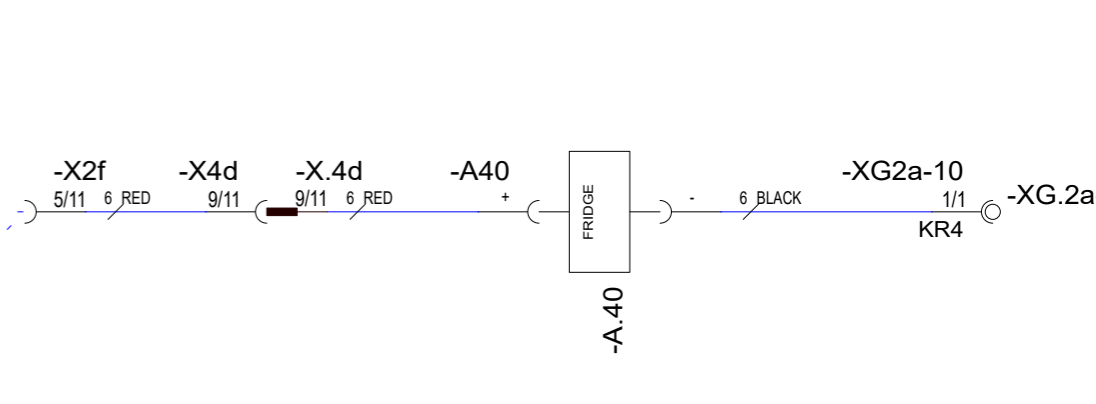
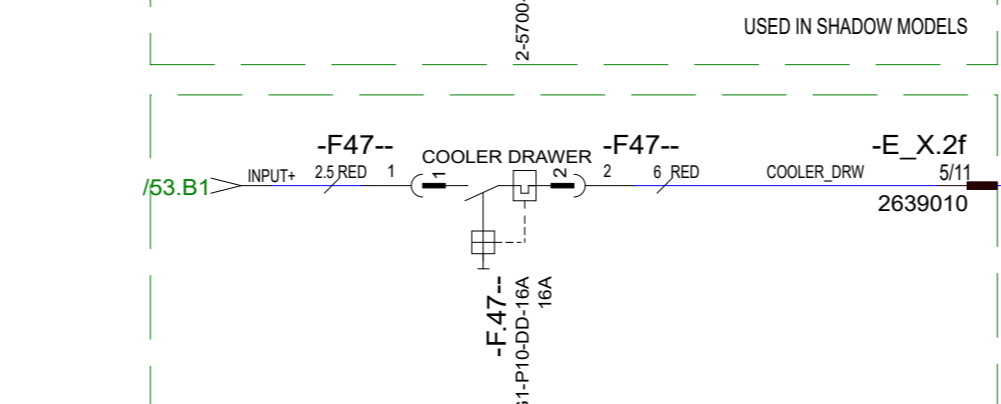
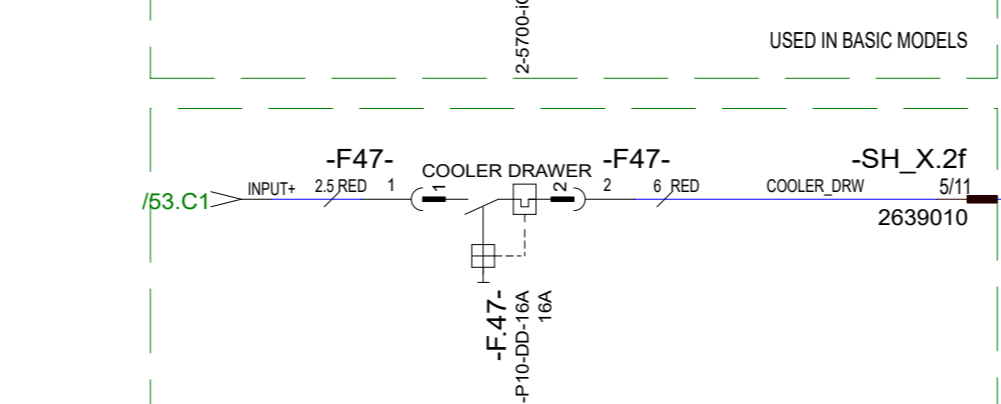
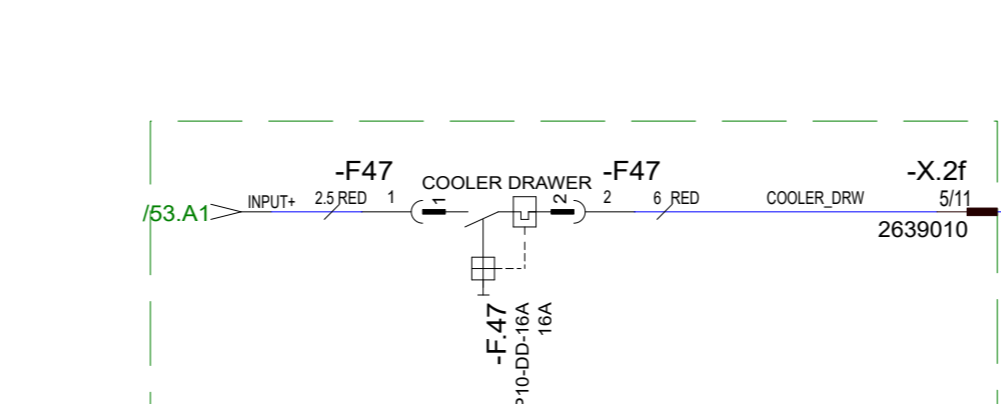
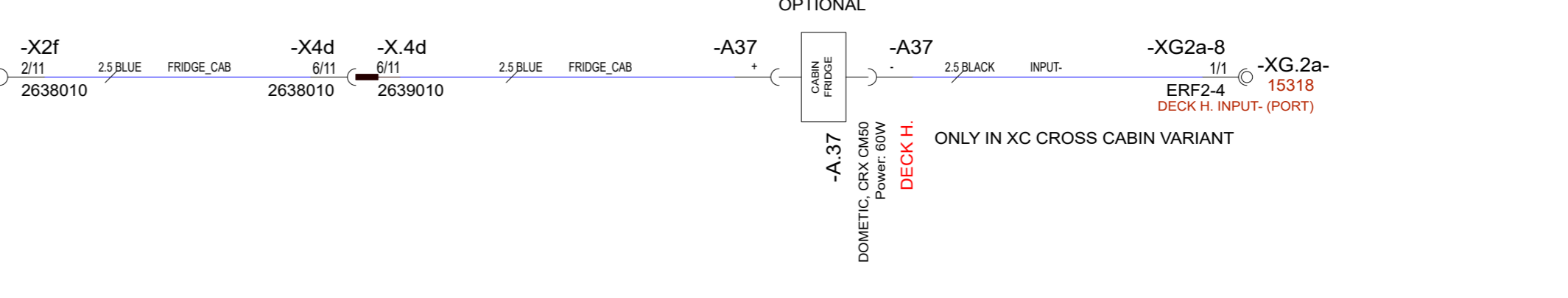
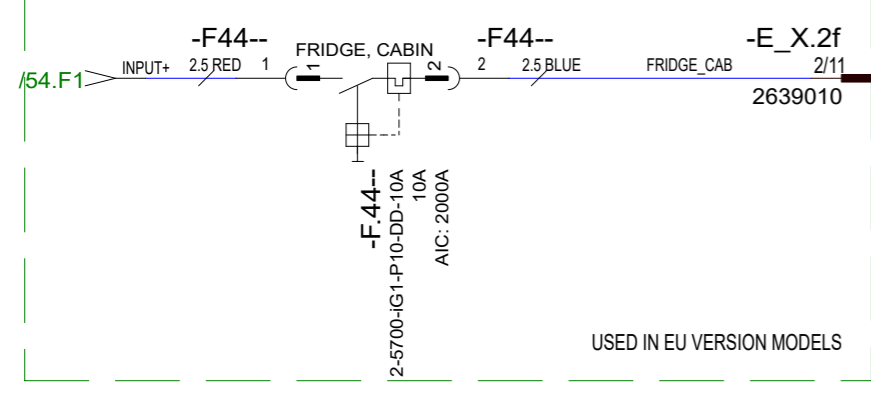
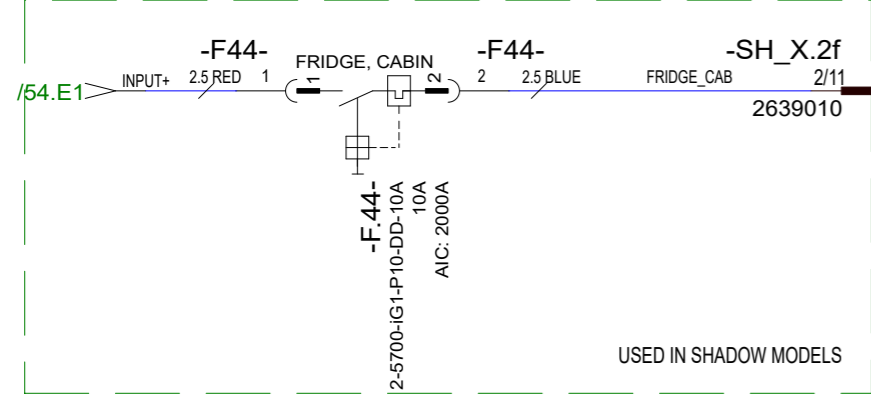
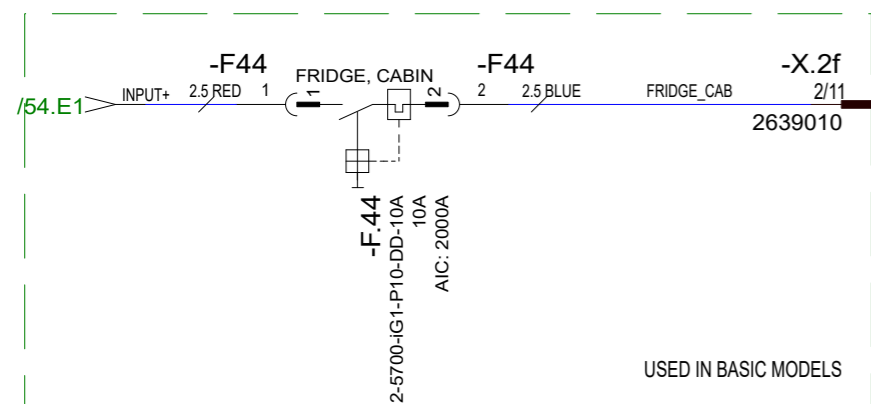

10.10.2023	PF	F22: 2004916; Not modified
20.2.2024	PF	G23; 2005054; A40 Cooler/fridge 10A -> 16A, wiring added
17.2.2023	RK	F21: NOT MODIFIED
Date of modification	Modified by	Description

Date	14.1.2019
Drawing by	TuM
Sheet rev.	23
Project rev.	G



Axopar			
Boat	37 MY20	Sub-product code	Product code
Boat model		REFRIGERATORS - DIAGRAM	Project ID
		HL	76 / 213
		Loc	Sheet

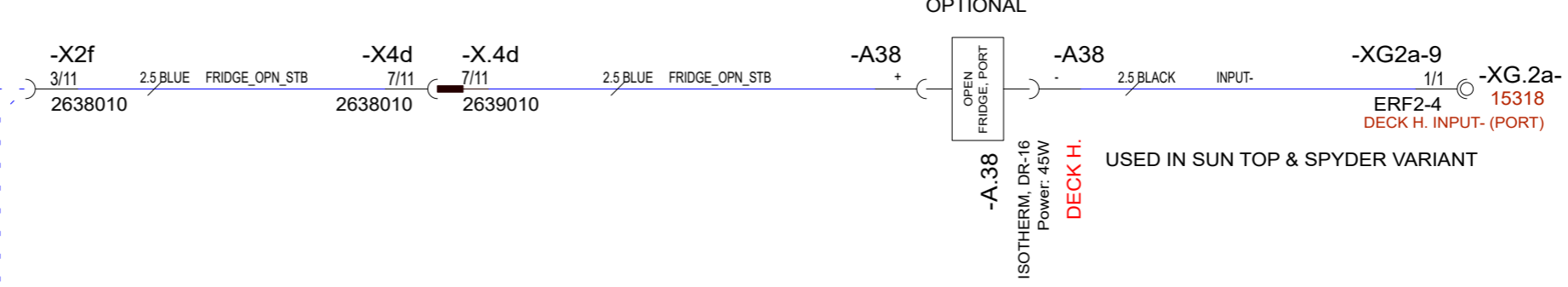
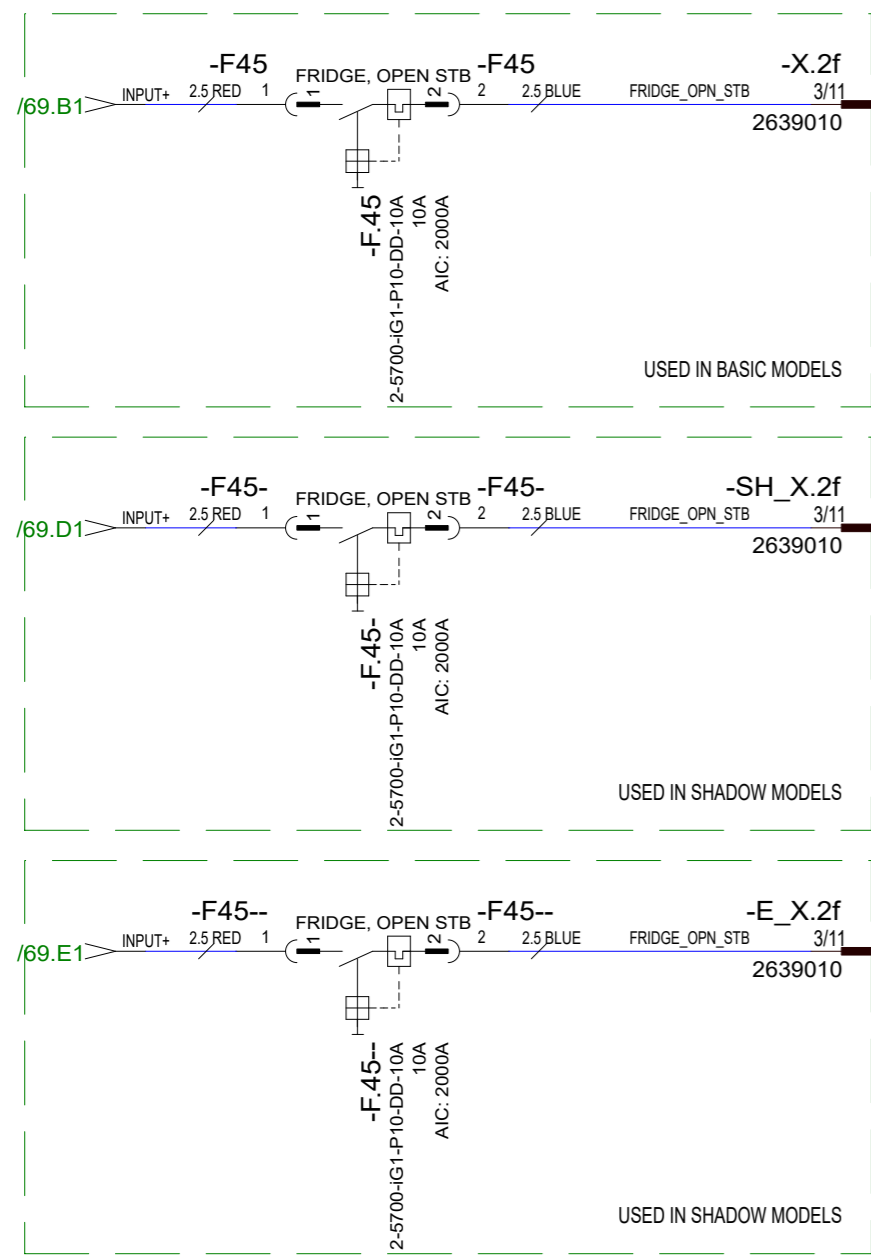

10.10.2023	PF	F22: 2004916; Not modified	Date	23.4.2020
20.2.2024	PF	G23; 2005054; Not modified	Drawing by	TuM
17.2.2023	RK	F21: NOT MODIFIED	Sheet rev.	23
Date of modification	Modified by	Description	Project rev.	G



Axopar			
Boat	37 MY20	Sub-product code	Product code
Boat model		REFRIGERATORS - DIAGRAM	Project ID
		HL	77 / 213
		Loc	Sheet

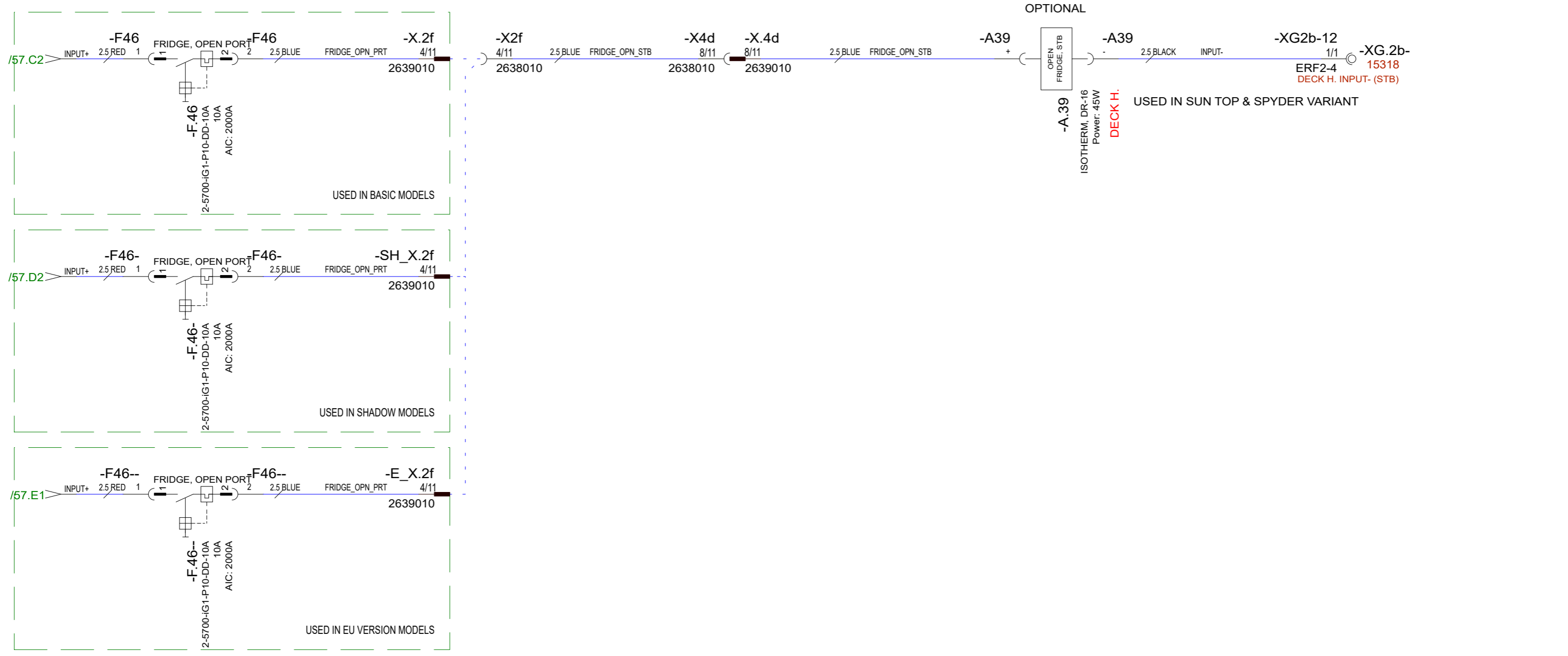

10.10.2023	PF	F22: 2004916; Not modified	Date	23.04.2020
20.2.2024	PF	G23; 2005054; Not modified	Drawing by	TuM
17.2.2023	RK	F21: NOT MODIFIED	Sheet rev.	23
Date of modification	Modified by	Description	Project rev.	G



Axopar			
Boat	37 MY20	Sub-product code	Product code
Boat model		REFRIGERATORS - DIAGRAM	Project ID
		HL	78 / 213
		Loc	Sheet

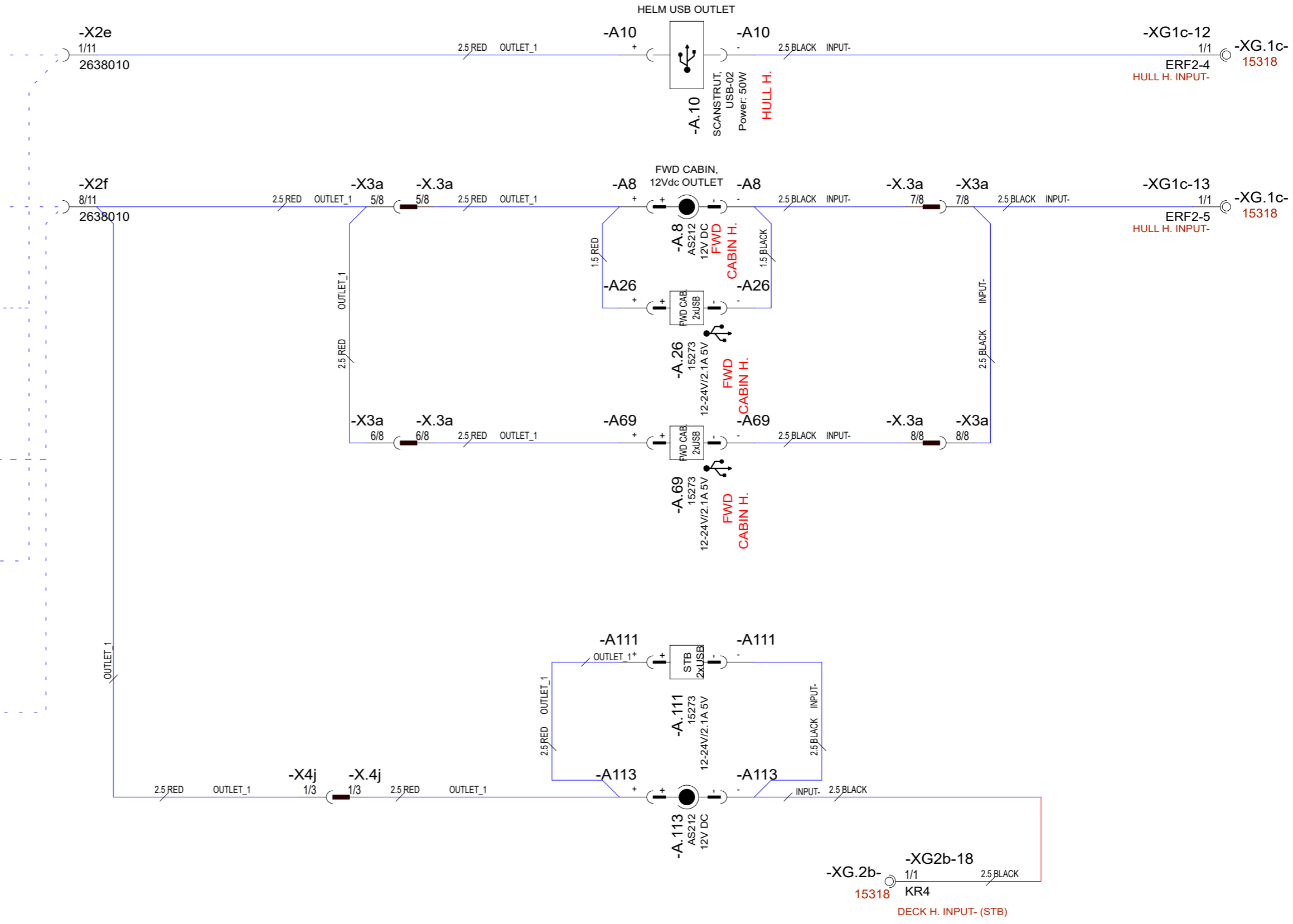
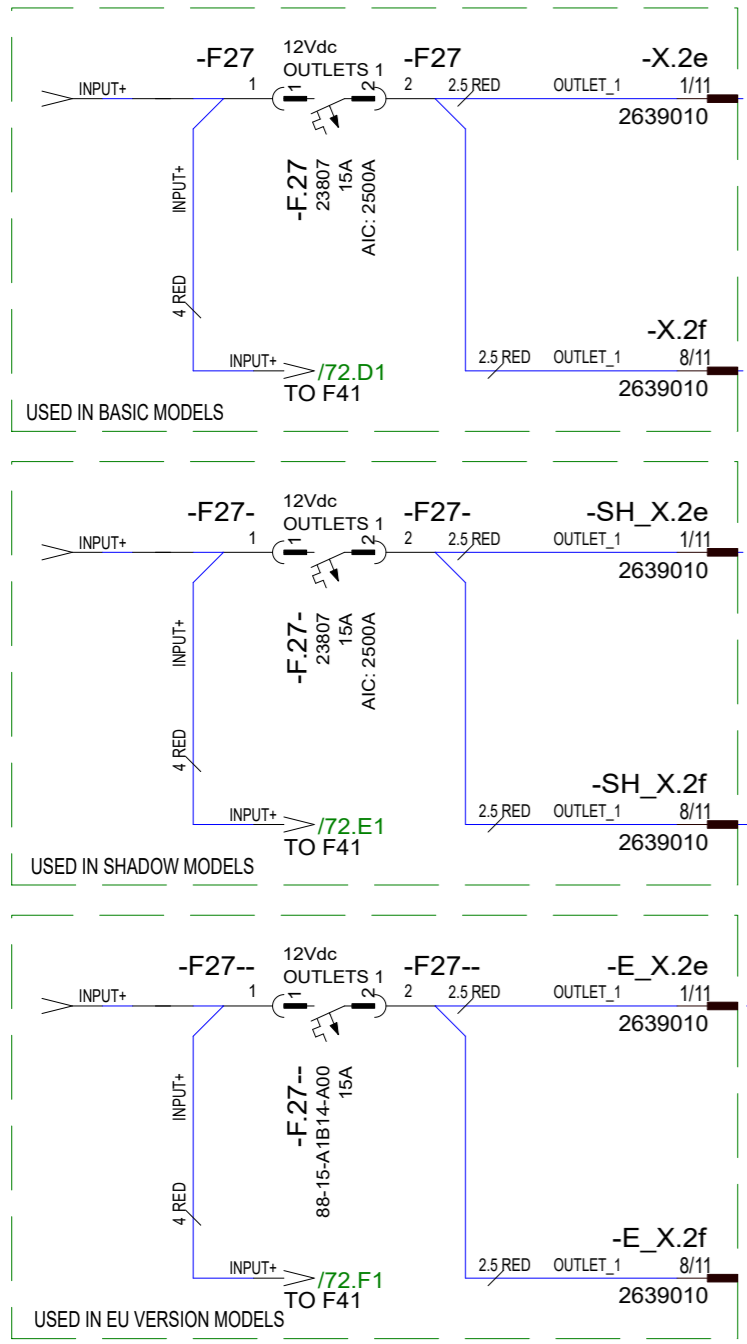

10.10.2023	PF	F22: 2004916; Added A111, A113 & X4j	Date	14.1.2019
20.2.2024	PF	G23; 2005054; Wire sizes	Drawing by	TuM
17.2.2023	RK	F21: NOT MODIFIED	Sheet rev.	23
Date of modification	Modified by	Description	Project rev.	G



Axopar					
Boat	37 MY20	Sub-product code	Product code	Project ID	
Boat model		12Vdc OUTLETS/ USB - DIAGRAM		HL	79 / 213
		Title		Loc	

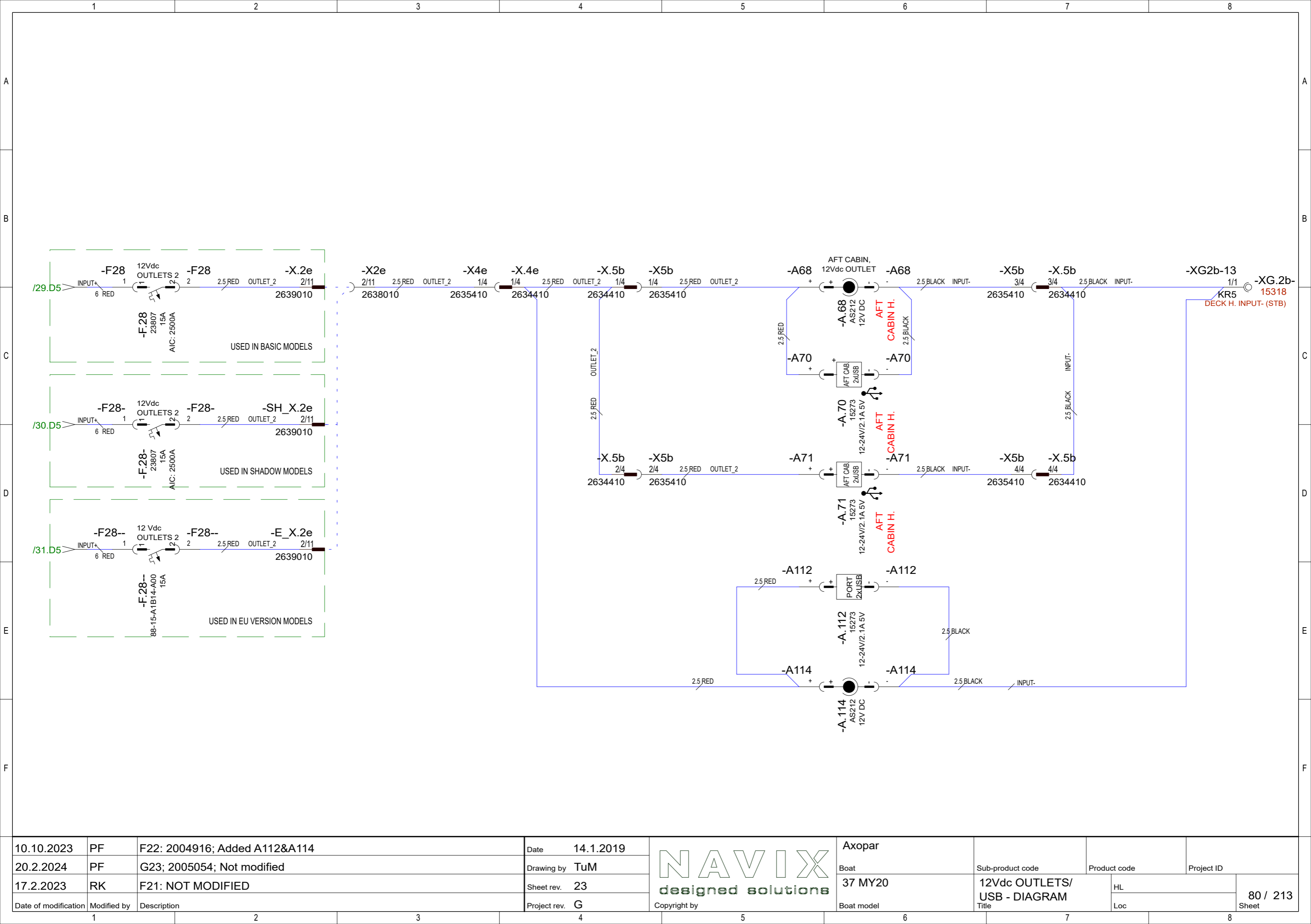

10.10.2023	PF	F22: 2004916; Added A112&A114	Date	14.1.2019
20.2.2024	PF	G23; 2005054; Not modified	Drawing by	TuM
17.2.2023	RK	F21: NOT MODIFIED	Sheet rev.	23
Date of modification	Modified by	Description	Project rev.	G



Axopar			
Boat	37 MY20	Sub-product code	Product code
Boat model		12Vdc OUTLETS/ USB - DIAGRAM	Project ID
		HL	80 / 213
		Loc	Sheet

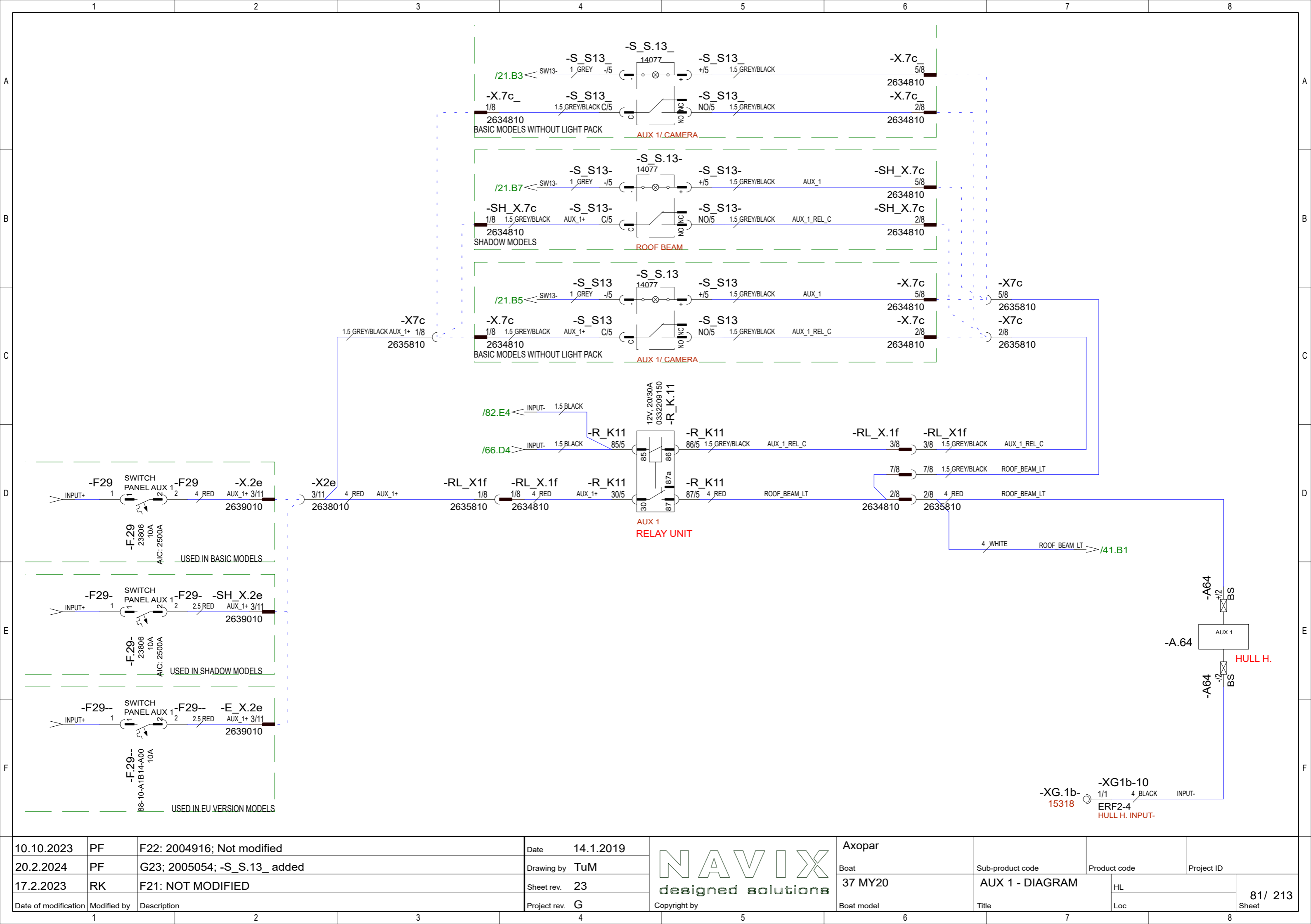

10.10.2023	PF	F22: 2004916; Not modified	Date	14.1.2019
20.2.2024	PF	G23; 2005054; -S_S.13_ added	Drawing by	TuM
17.2.2023	RK	F21: NOT MODIFIED	Sheet rev.	23
Date of modification	Modified by	Description	Project rev.	G



Axopar	Boat	37 MY20	Sub-product code	AUX 1 - DIAGRAM	Product code	HL	Project ID	81/ 213
	Boat model		Title		Loc			Sheet

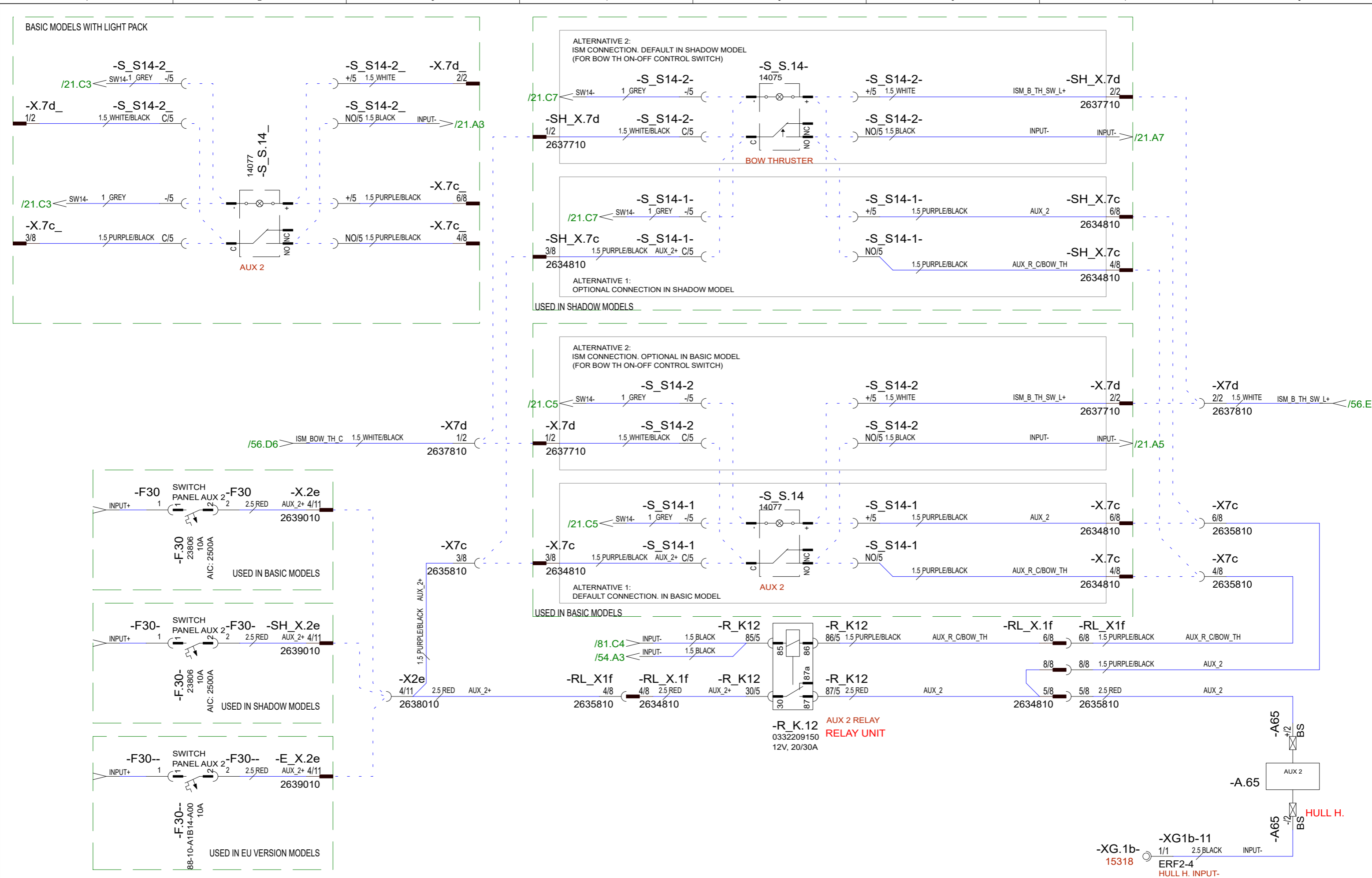

10.10.2023	PF	F22: 2004916; Not modified	Date	14.1.2019
20.2.2024	PF	G23; 2005054; -S_S.14_ added	Drawing by	TuM
17.2.2023	RK	F21: NOT MODIFIED	Sheet rev.	23
Date of modification	Modified by	Description	Project rev.	G



Axopar	Boat	37 MY20	Sub-product code	Product code	Project ID
			AUX 2/BOW THRUSTER		
			- DIAGRAM		82 / 213
			Title	Loc	Sheet

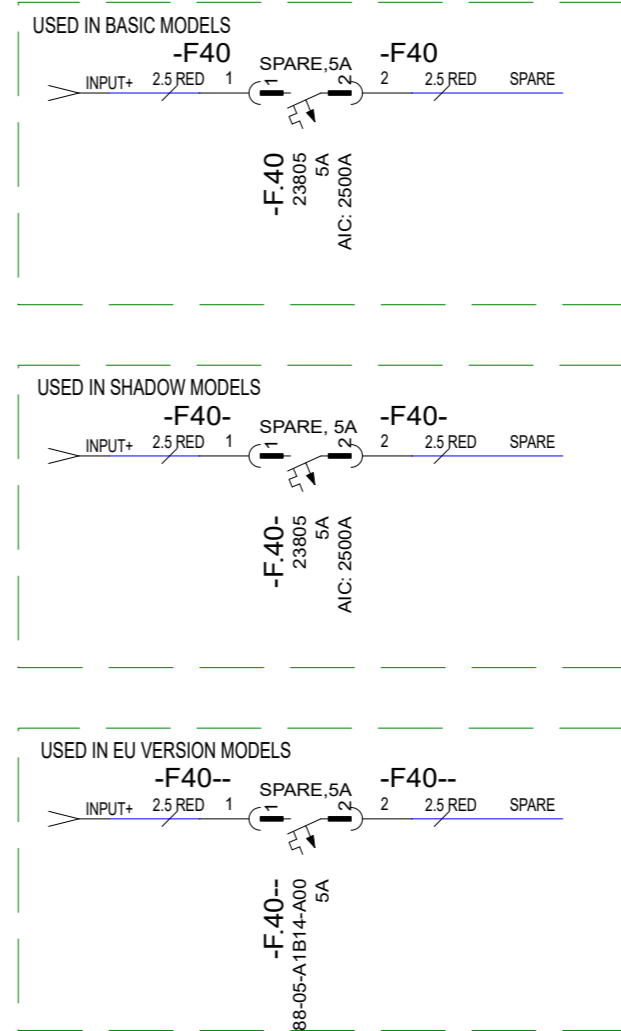
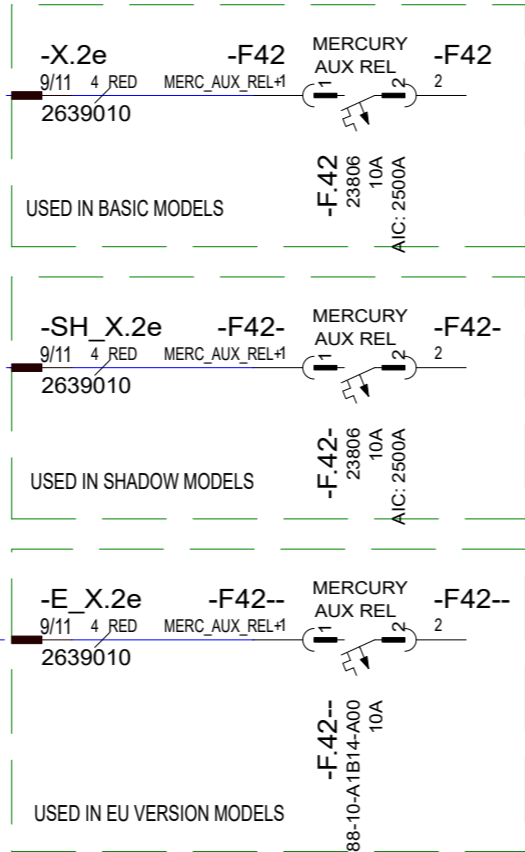
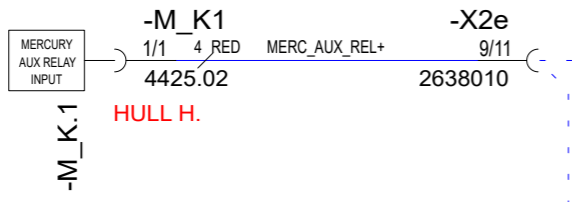
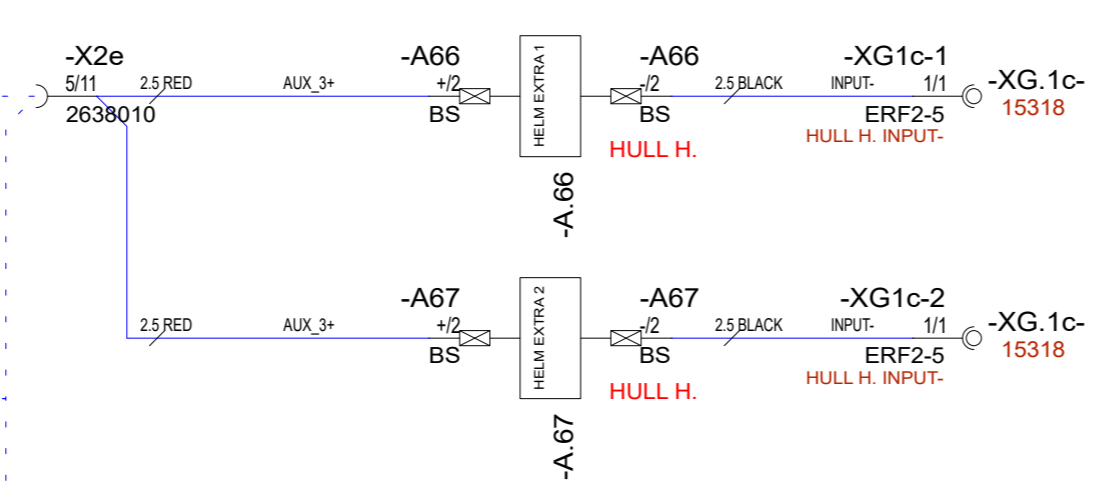
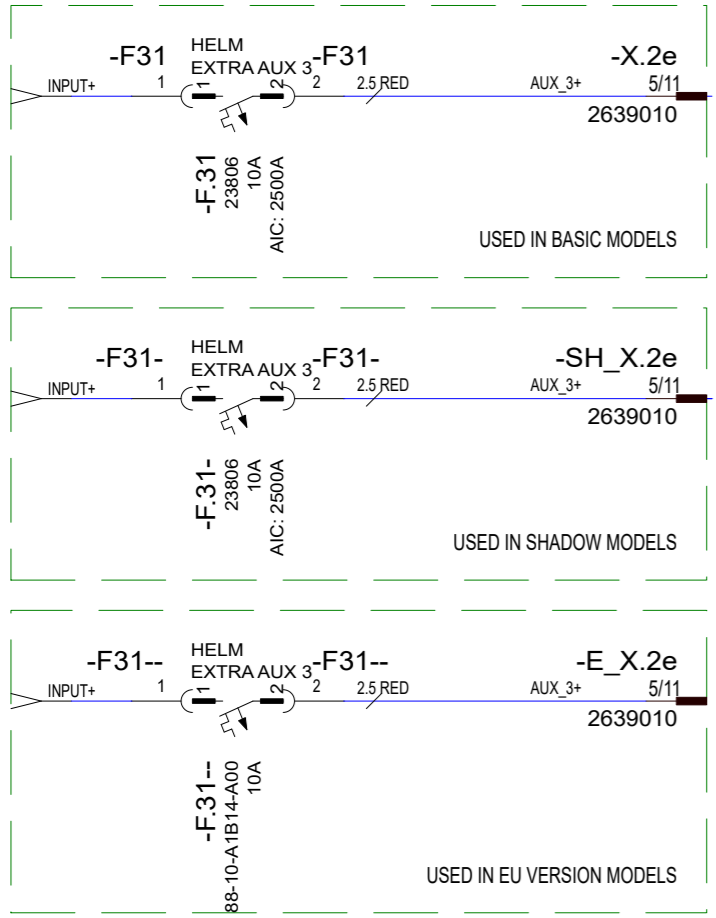

10.10.2023	PF	F22: 2004916; Not modified	Date	14.1.2019
20.2.2024	PF	G23; 2005054; Not modified	Drawing by	TuM
17.2.2023	RK	F21: NOT MODIFIED	Sheet rev.	23
Date of modification	Modified by	Description	Project rev.	G



Axopar					
Boat	37 MY20	Sub-product code	AUX 3, SPARE, EXTRA, MERCURY AUX - DIAGRAM	Product code	HL
Boat model		Title		Project ID	83 / 213
				Loc	Sheet

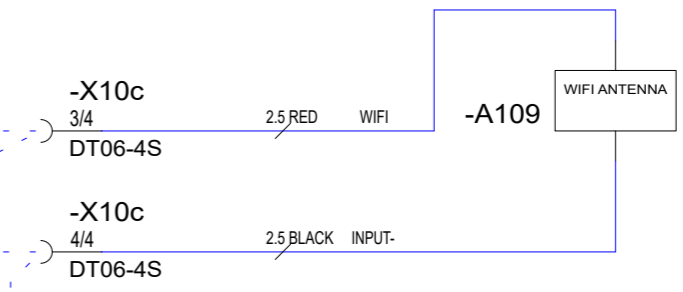
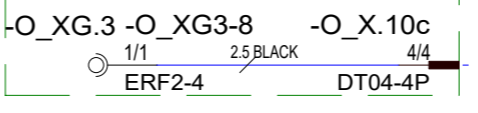
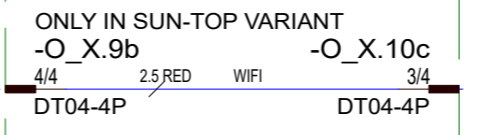
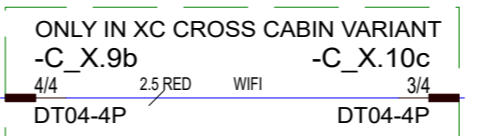
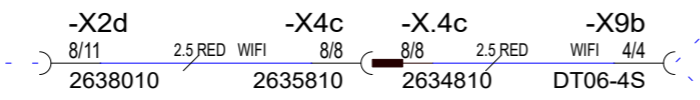
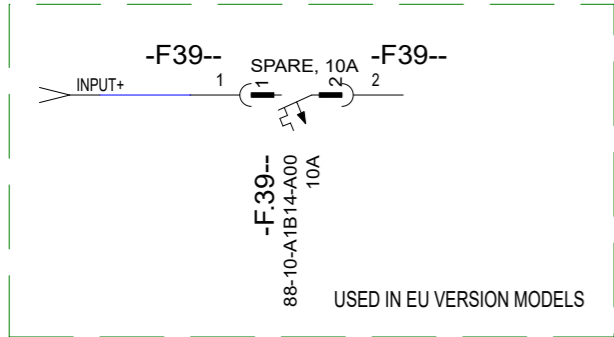
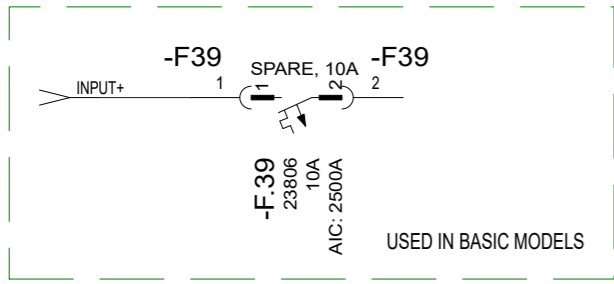
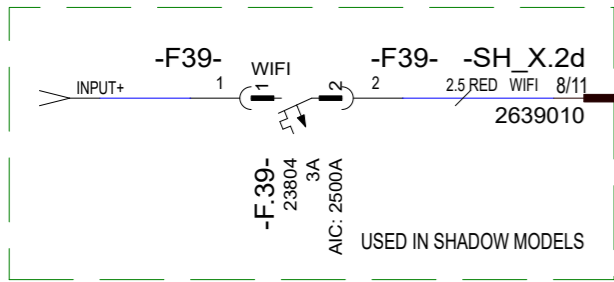

10.10.2023	PF	F22: 2004916; Not modified	Date	15.06.2021
20.2.2024	PF	G23; 2005054; Wifi minus 1,5mm2->2,5mm2	Drawing by	TuM
17.2.2023	RK	F21: NOT MODIFIED	Sheet rev.	23
Date of modification	Modified by	Description	Project rev.	G



Axopar					
Boat	37 MY20	Sub-product code	WIFI - DIAGRAM	Product code	Project ID
Boat model		Title		HL	84 / 213
				Loc	Sheet

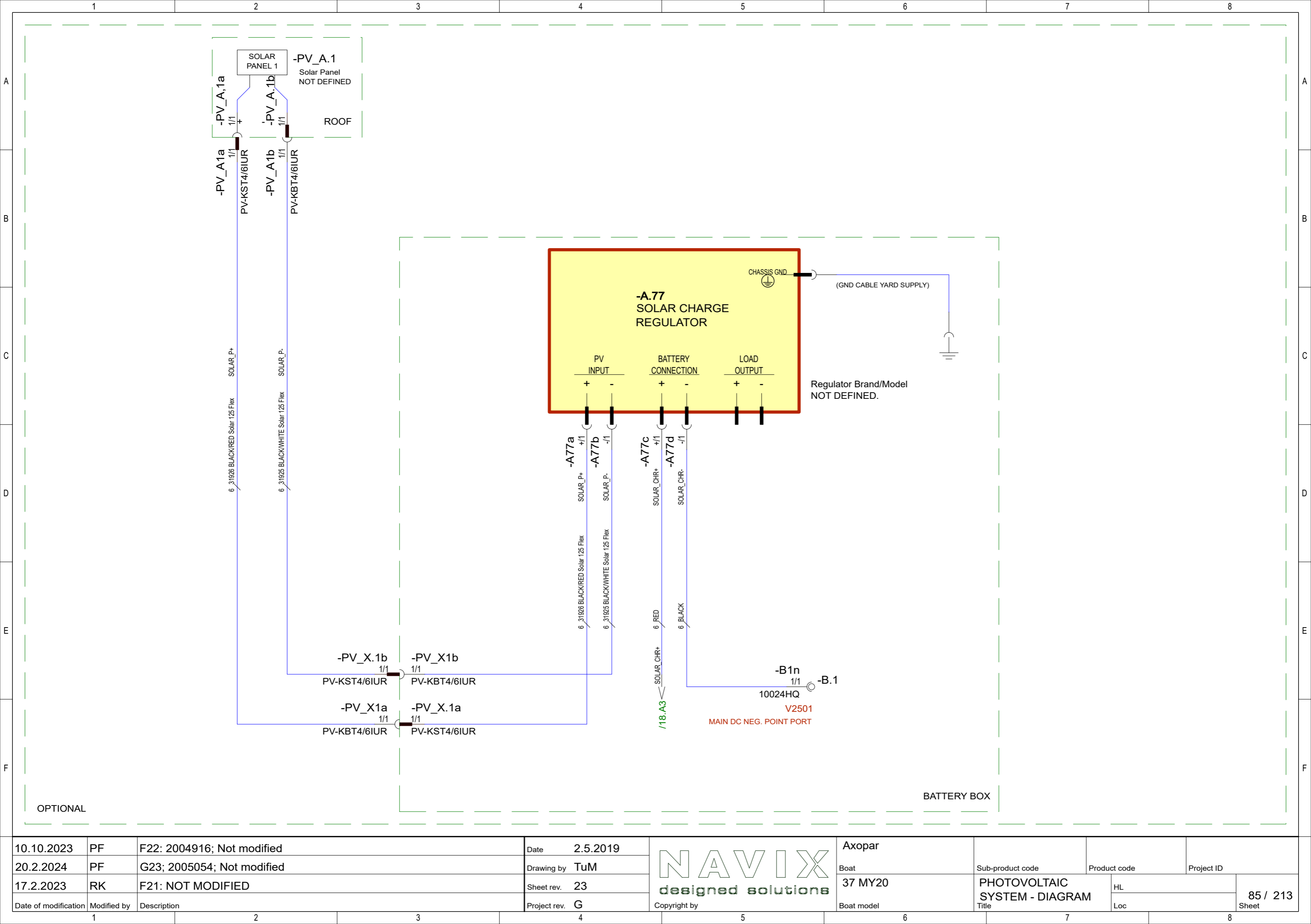

10.10.2023	PF	F22: 2004916; Not modified
20.2.2024	PF	G23; 2005054; Not modified
17.2.2023	RK	F21: NOT MODIFIED
Date of modification	Modified by	Description

Date	2.5.2019
Drawing by	TuM
Sheet rev.	23
Project rev.	G



Axopar
Boat
37 MY20
Boat model

Sub-product code	Product code	Project ID
PHOTOVOLTAIC SYSTEM - DIAGRAM		HL
Title	Loc	85 / 213 Sheet

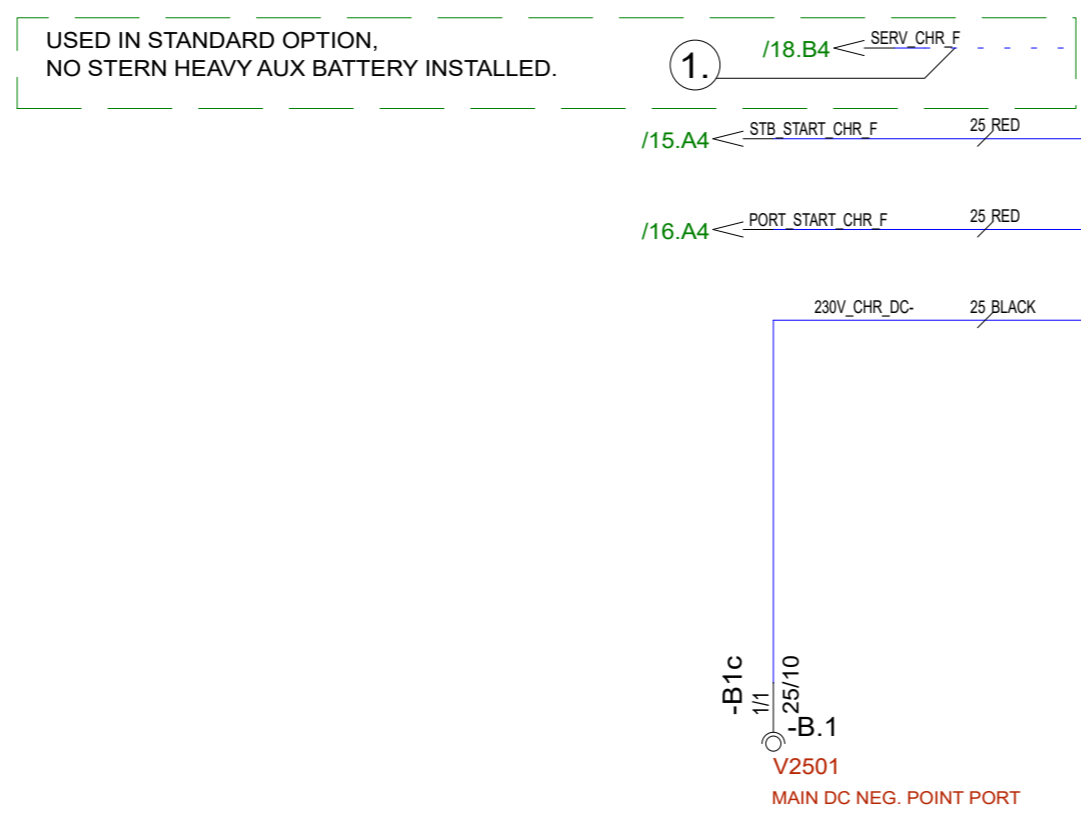
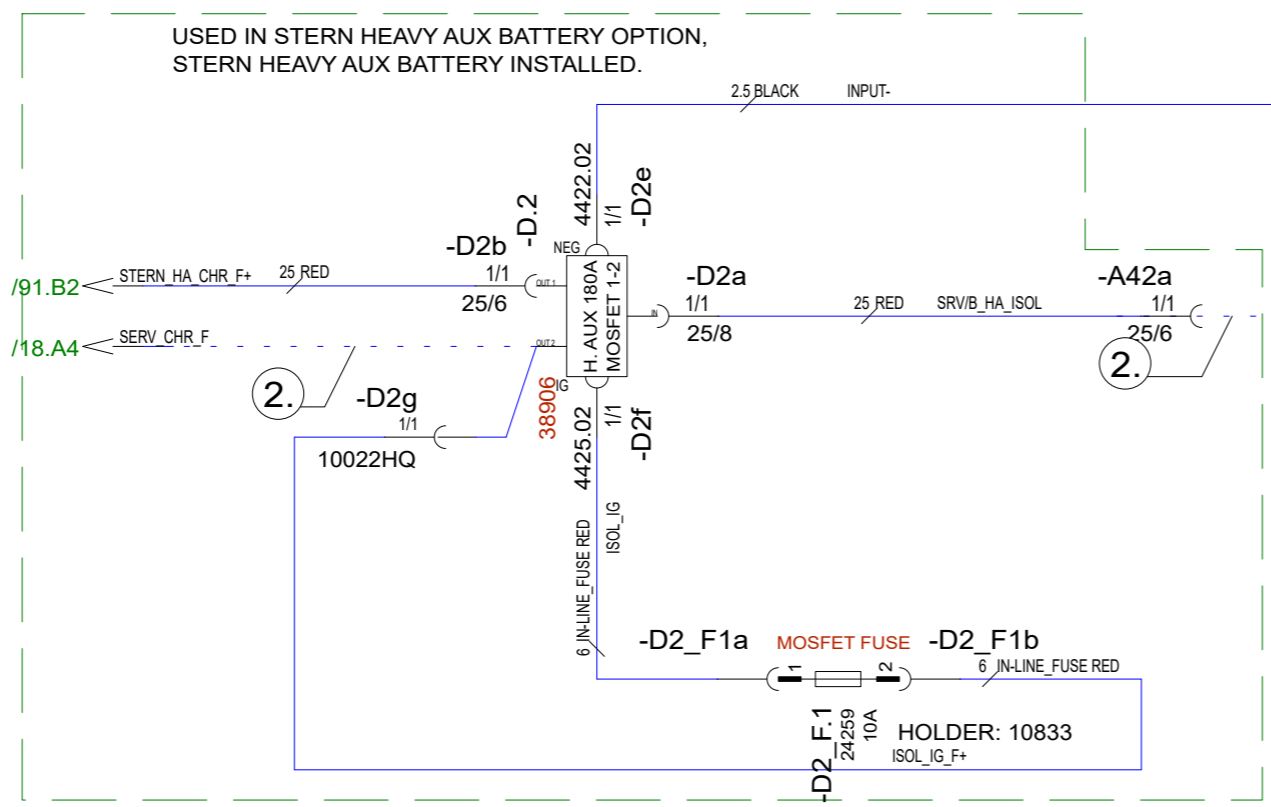

-B2k
1/1
ERF2-10
-B.2
V2501
MAIN DC NEG. POINT STB

BATTERY CHARGER ALTERNATIVES:

- ALTERNATIVE 1,
NO STERN HA BATTERY SYSTEM INSTALLED:
CONNECT "-CH_X1" TO "A.42"
BATTERY CHARGER'S PIN (1).
- ALTERNATIVE 2,
STERN HA BATTERY SYSTEM INSTALLED:
CONNECT "-CH_X1" TO "D.2" OUT 2 AND
CONNECT "-A42a" TO "A.42"
BATTERY CHARGER'S PIN (1).

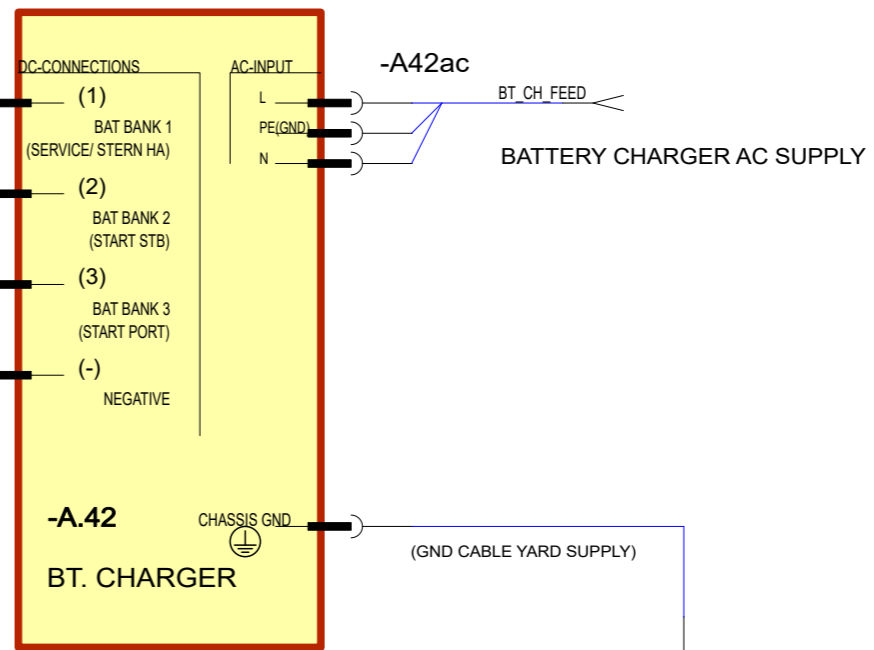

STANDARD: Whisper Power WBC Supreme 40A
SHADOW: Whisper Power WBC Supreme 60A

40A Charger: 3,0A
60A Charger: 4,6A
Max. Power: 1058W

INCLUDES IN CHARGER OUTPUT:
50A FUSES/LINE WITH 40 CHARGER
80A FUSES/LINE WITH 60 CHARGER

LINE 1 (BANK 1) IS SEPARATE LINE

LINES 2 & 3 (BANKS 2 & 3) ARE PARALLEL LINES BUT SEPARATED WITH DIODES.

TO COMMON GROUNDING POINT

10.10.2023	PF	F22: 2004916; Not modified	Date	14.1.2019
20.2.2024	PF	G23; 2005054; Charging moved from bow th to stern th	Drawing by	TuM
17.2.2023	RK	F21: NOT MODIFIED	Sheet rev.	23
Date of modification	Modified by	Description	Project rev.	G



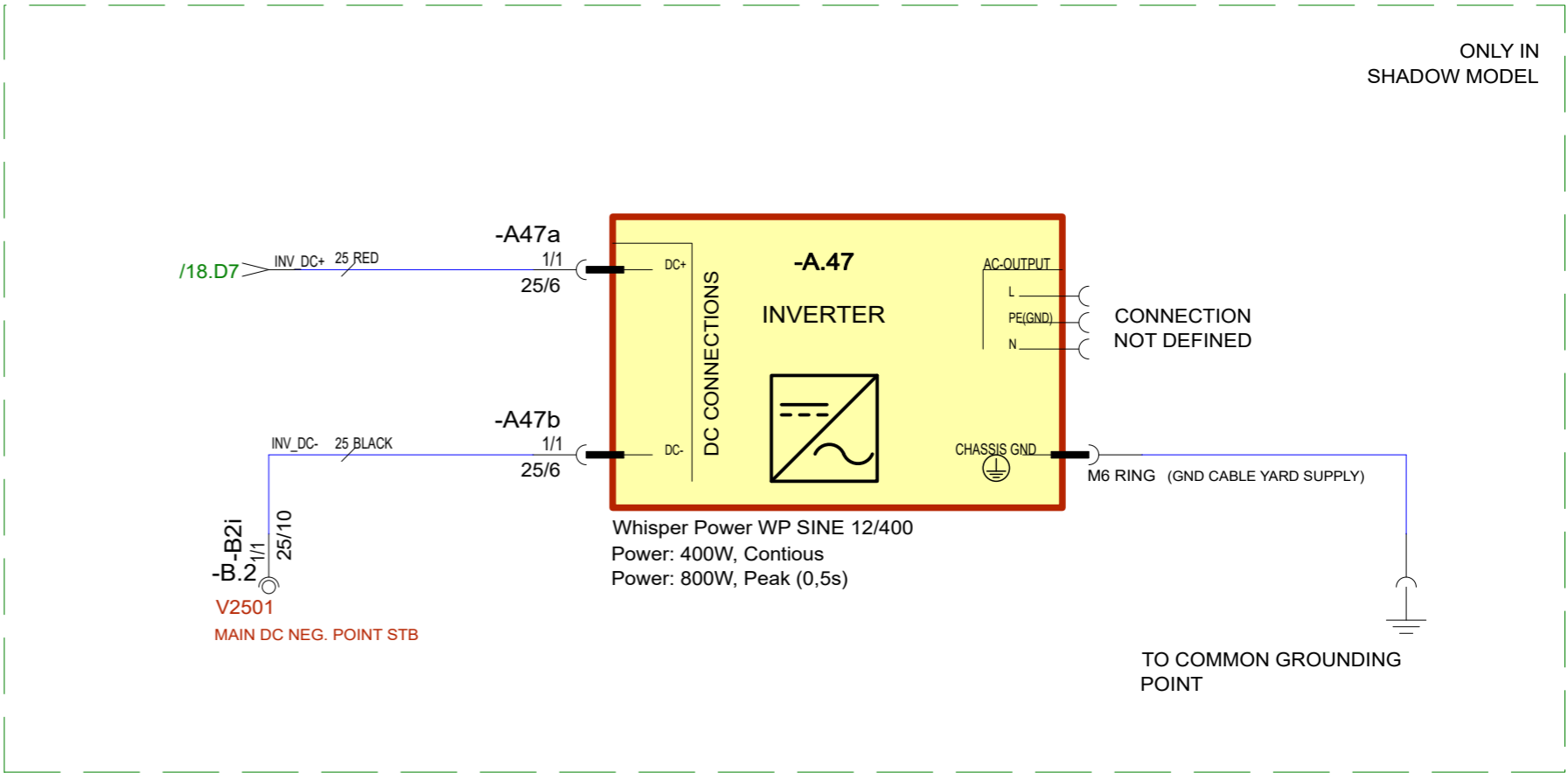

Axopar				
Boat	37 MY20	Sub-product code	Product code	Project ID
Boat model		BATTERY CHARGER - DIAGRAM		HL
			Loc	86 / 213 Sheet

	1	2	3	4	5	6	7	8
A								
B								
C								
D								
E								
F								

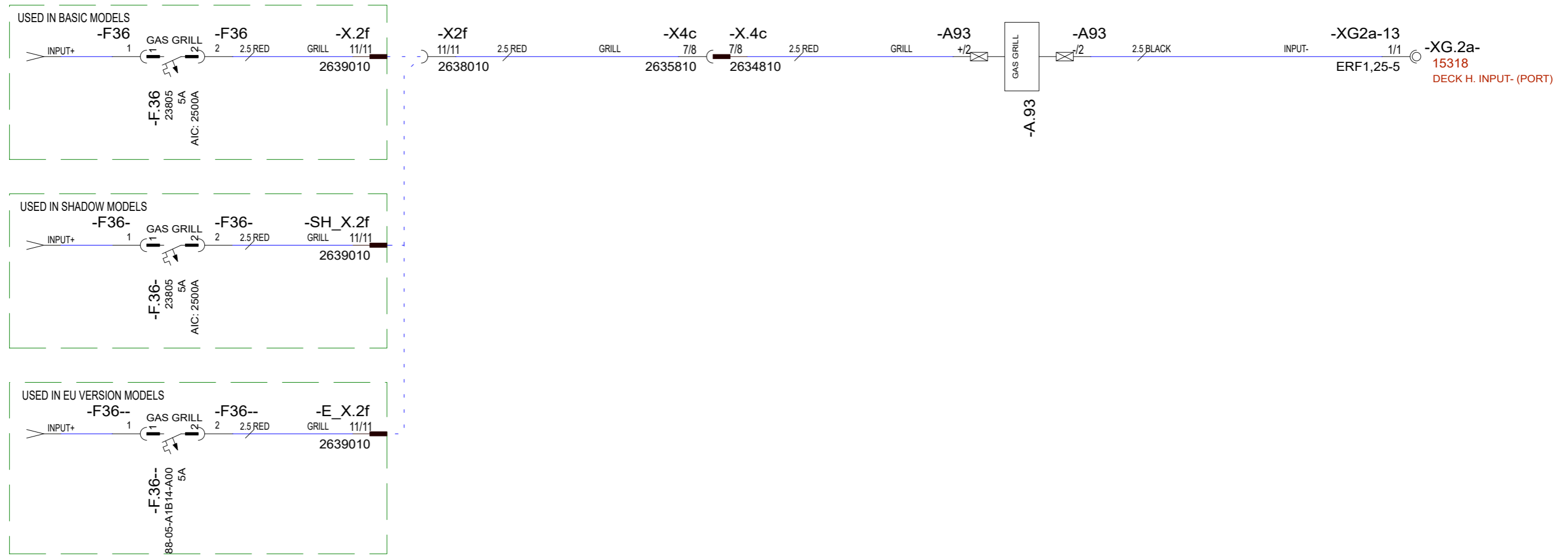

10.10.2023	PF	F22: 2004916; Not modified	Date	14.1.2019	 NAVIX designed solutions Copyright by	Axopar			
20.2.2024	PF	G23; 2005054; Not modified	Drawing by	TuM		Boat	Sub-product code	Product code	Project ID
17.2.2023	RK	F21: NOT MODIFIED	Sheet rev.	23		37 MY20	INVERTER - DIAGRAM	HL	87 / 213 Sheet
Date of modification	Modified by	Description	Project rev.	G		Boat model	Title	Loc	



10.10.2023	PF	F22: 2004916; Not modified	Date	28.08.2020	 Copyright by	Axopar			
20.2.2024	PF	G23; 2005054; Not modified	Drawing by	TuM		Boat	Sub-product code	Product code	Project ID
17.2.2023	RK	F21: NOT MODIFIED	Sheet rev.	23		37 MY20	GAS GRILL - DIAGRAM		HL
Date of modification	Modified by	Description	Project rev.	G		Boat model	Title	Loc	88 / 213 Sheet

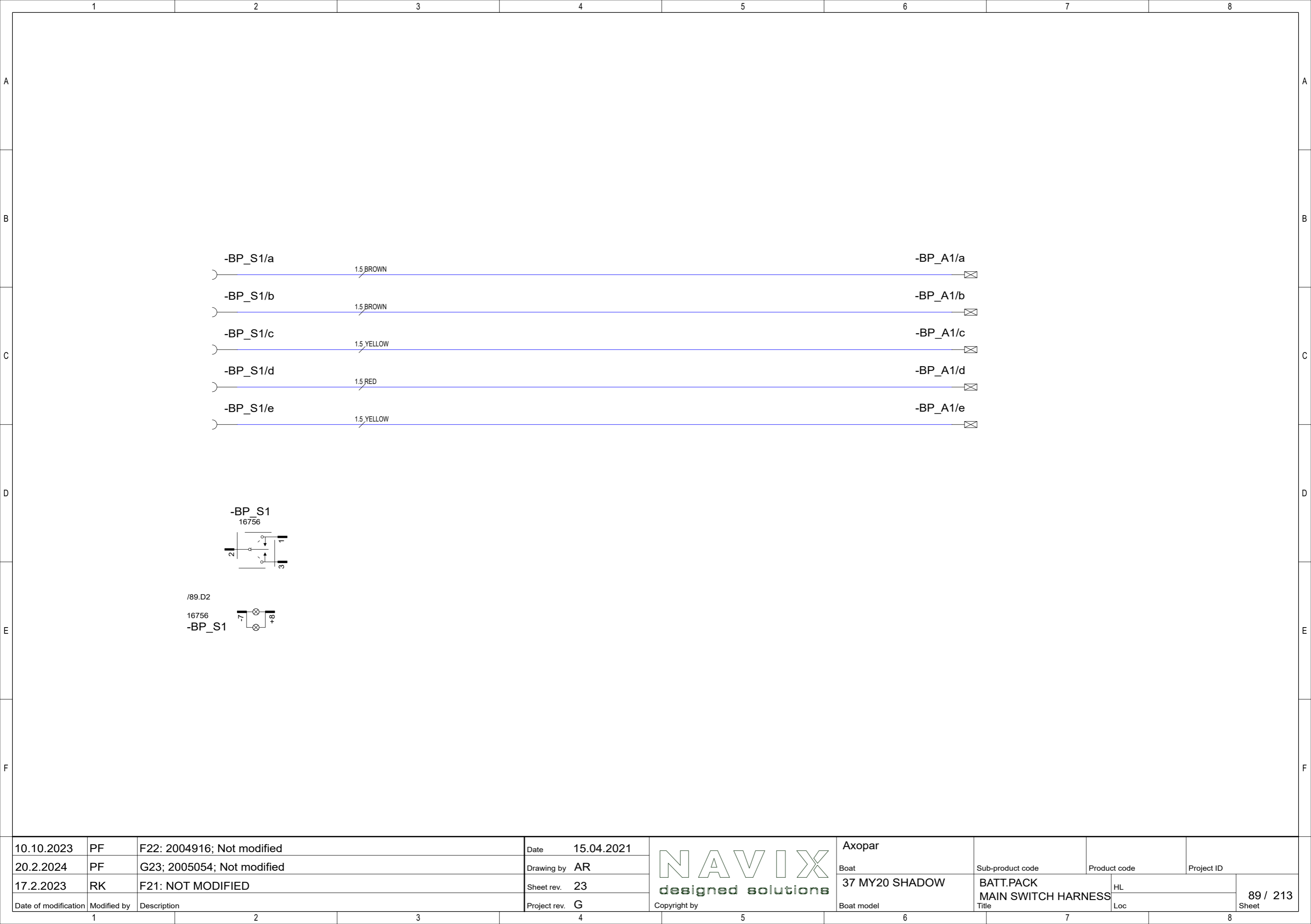

10.10.2023	PF	F22: 2004916; Not modified	Date	15.04.2021
20.2.2024	PF	G23; 2005054; Not modified	Drawing by	AR
17.2.2023	RK	F21: NOT MODIFIED	Sheet rev.	23
Date of modification	Modified by	Description	Project rev.	G

		Axopar					
		Boat	37 MY20 SHADOW	Sub-product code		Product code	
Copyright by		Boat model		BATT.PACK MAIN SWITCH HARNESS		HL	
				Title		Loc	
						89 / 213 Sheet	

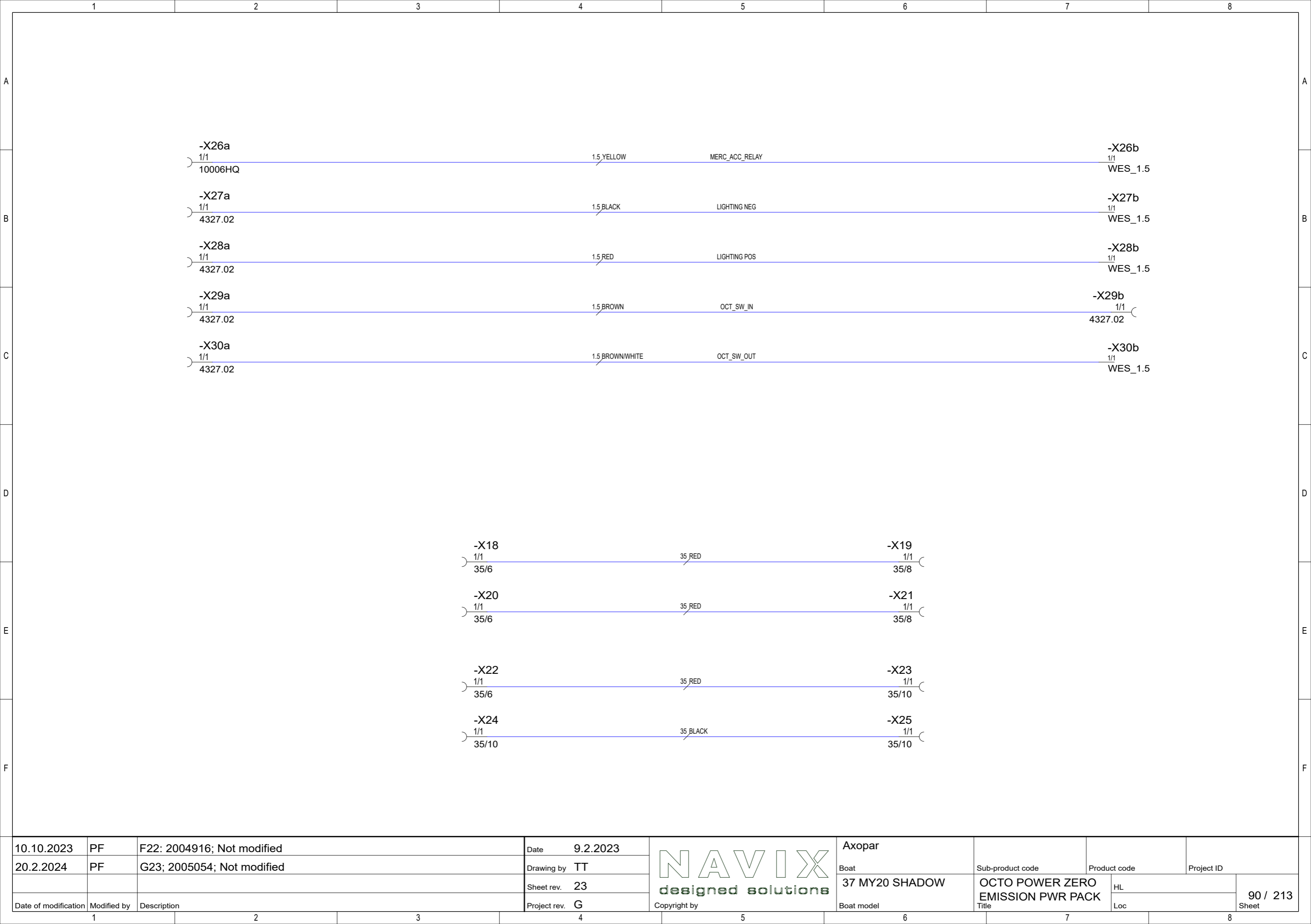

10.10.2023	PF	F22; 2004916; Not modified
20.2.2024	PF	G23; 2005054; Not modified
Date of modification	Modified by	Description

Date	9.2.2023
Drawing by	TT
Sheet rev.	23
Project rev.	G



Axopar			
Boat	37 MY20 SHADOW	Sub-product code	Product code
Boat model		OCTO POWER ZERO EMISSION PWR PACK	HL
		Title	Loc
			90 / 213
			Sheet

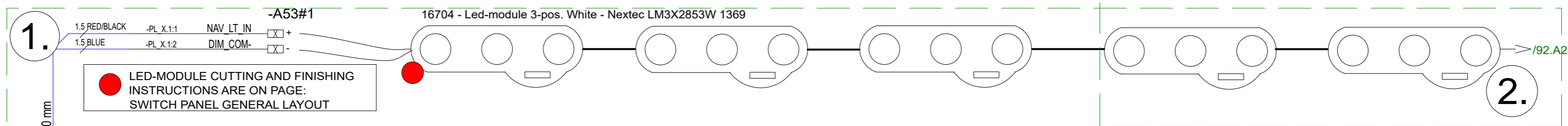

LED-MODULE CUTTING AND FINISHING INSTRUCTIONS ARE ON PAGE: SWITCH PANEL GENERAL LAYOUT

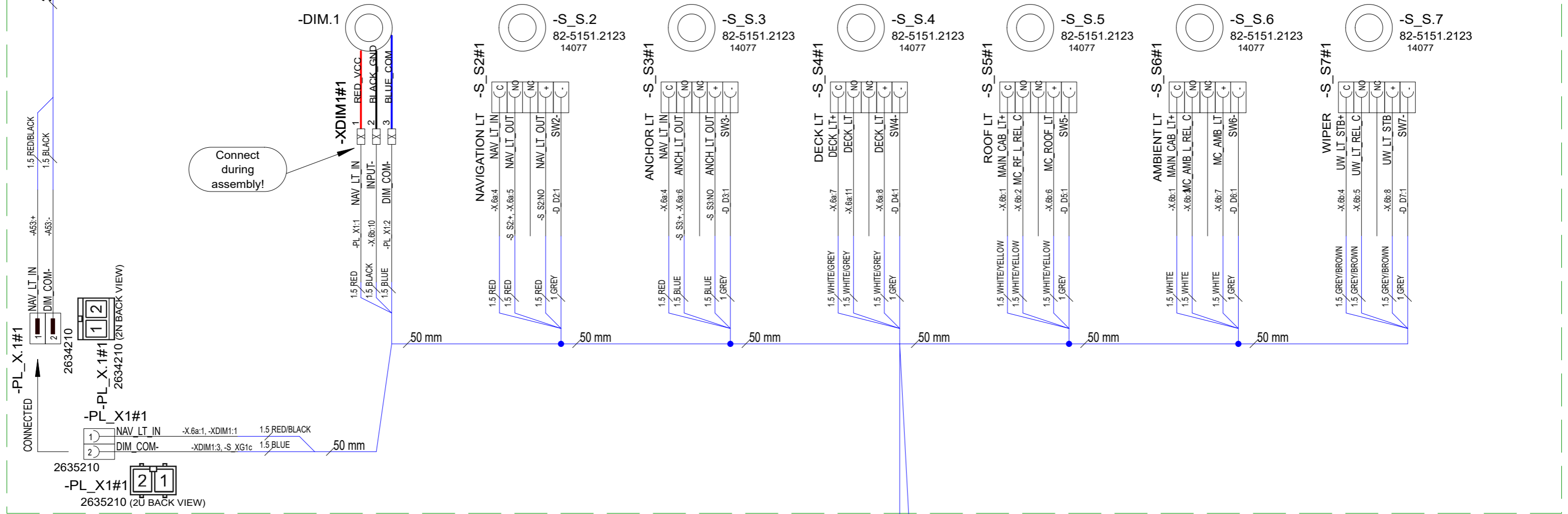

Connect during assembly!

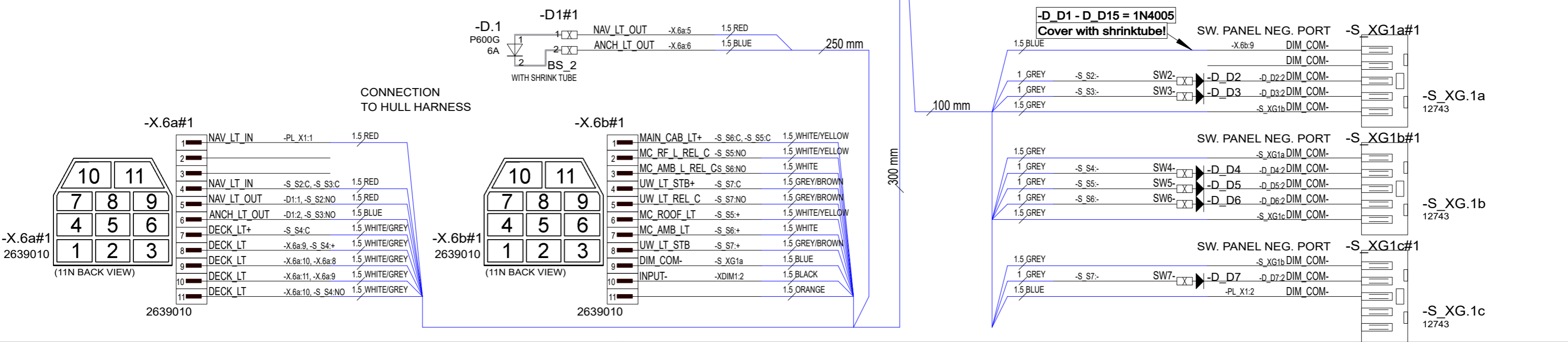

16.10.2023	PF	F8: 2004916; Added dimming feature, F9: Bilge halo dimming removed
15.03.2024	PF	G10:2005054; Added s15, S1 replaced with dimmer, test instruction update
17.2.2023	RK	F7: NOT MODIFIED.
Date of modification	Modified by	Description

Date	22.5.2019
Drawing by	TuM
Sheet rev.	10
Project rev.	G



Axopar	SEE EXP VIEW	29211	
Boat	Sub-product code	Product code	Project ID
37 MY20	SWITCH PANEL	HL	91/ 213
Boat model	Title	Loc	Sheet

3.

LED-MODULE CUTTING AND FINISHING INSTRUCTIONS ARE ON PAGE: SWITCH PANEL GENERAL LAYOUT

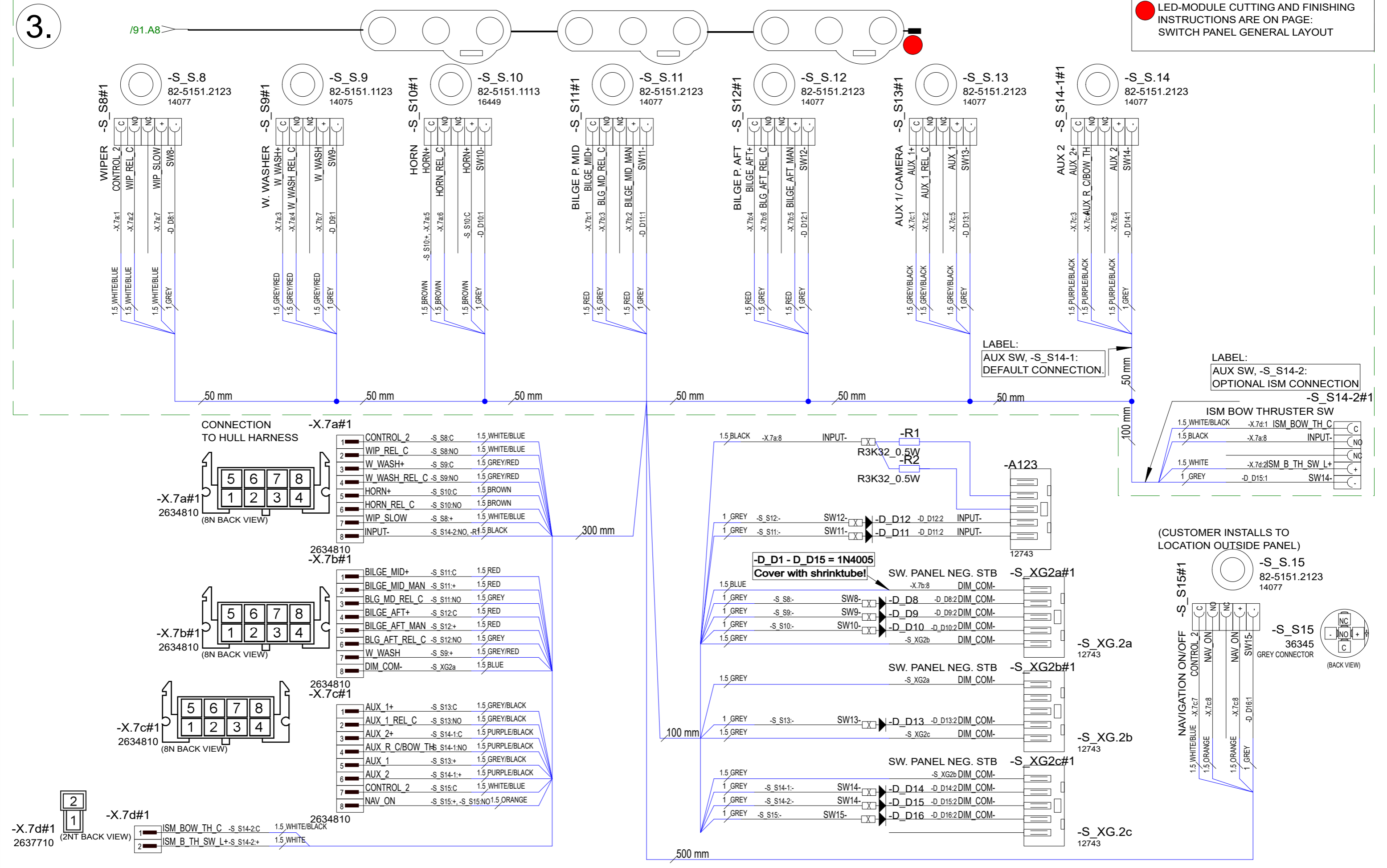

16.10.2023	PF	F8: 2004916; Added dimming feature, F9: Bilge halo dimming removed	Date	22.5.2019
15.03.2024	PF	G10:2005054; Added s15, S1 replaced with dimmer, test instruction update	Drawing by	TuM
17.2.2023	RK	F7: NOT MODIFIED.	Sheet rev.	10
Date of modification	Modified by	Description	Project rev.	G

NAVIX designed solutions

Copyright by

Axopar
Boat
37 MY20
Boat model

SEE EXP VIEW	29211	Project ID	92 / 213
Sub-product code	Product code	Project ID	
SWITCH PANEL	HL	Loc	Sheet
Title	Loc		

SWITCH PANEL GENERAL LAYOUT / LED MODULE CUTTING & FINISHING

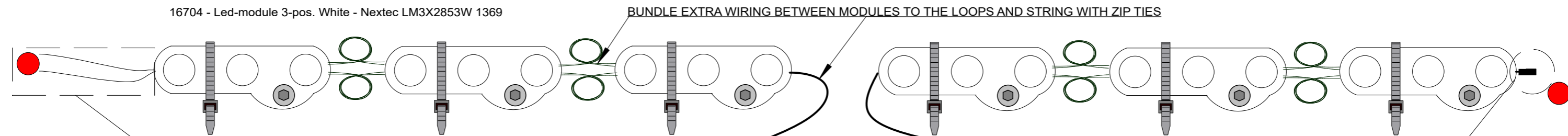
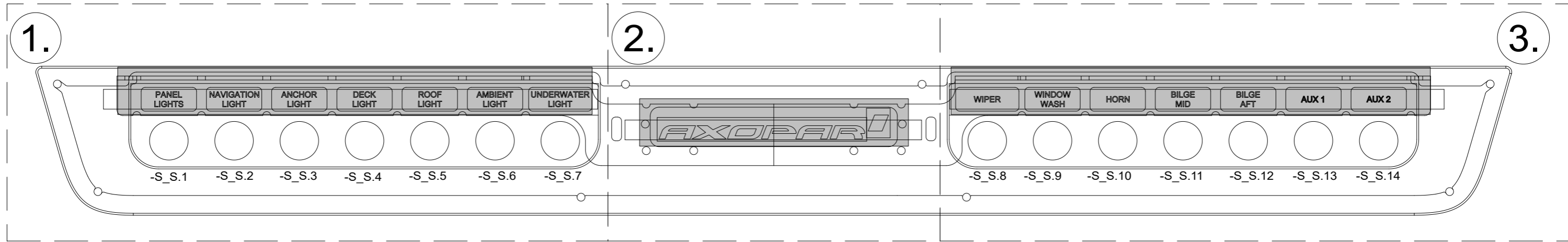

CUT LED MODULES INPUT SIDE OF THE WIRES APPROX. 60mm LENGTH (SHOULD BE ABOUT THE CENTER POS. BETWEEN 2 MODULES)
 STRIP WIRE ENDS APPROX. 7mm AND CRIMP WIRES TO THE BUTT SPLICE CONNECTORS -A53.

1. CUT THE WIRES APPROX. 40mm. (JUST CUT, DO NOT STRIP!)
 2. BEND THE WIRES TO THE SHAPE OF "U".
 3. ADD APPROX. 20mm OF HEAT SHRINK TUBE "17418" OVER THE BENDED WIRES.

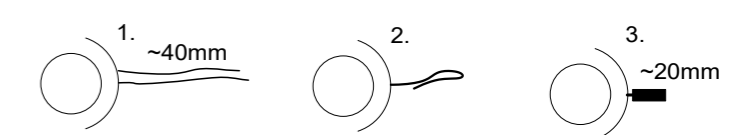

ATTACH ALL LED MODULES TO THE BRACKET 36371 WITH M3X12 BH HEX BOLT A4, NUT M3 AND 2-SIDED TAPE. ADD CABLE TIE. SEE ALSO EXP. VIEW
 TURN THE ENDS OF CABLE TIES TOWARDS TO THE PANEL!

NOTICE!
 VERIFY THAT ALL CABLES HAVE MARKINGS SHOWN IN EXAMPLE BELOW.
 EXEMPTION:
 ALL <500mm WIRES AND BLACK WIRES
 THIS MARKING IS NOT NEEDED.

EXAMPLE: RED 1,5mm² WIRE MARKINGS.

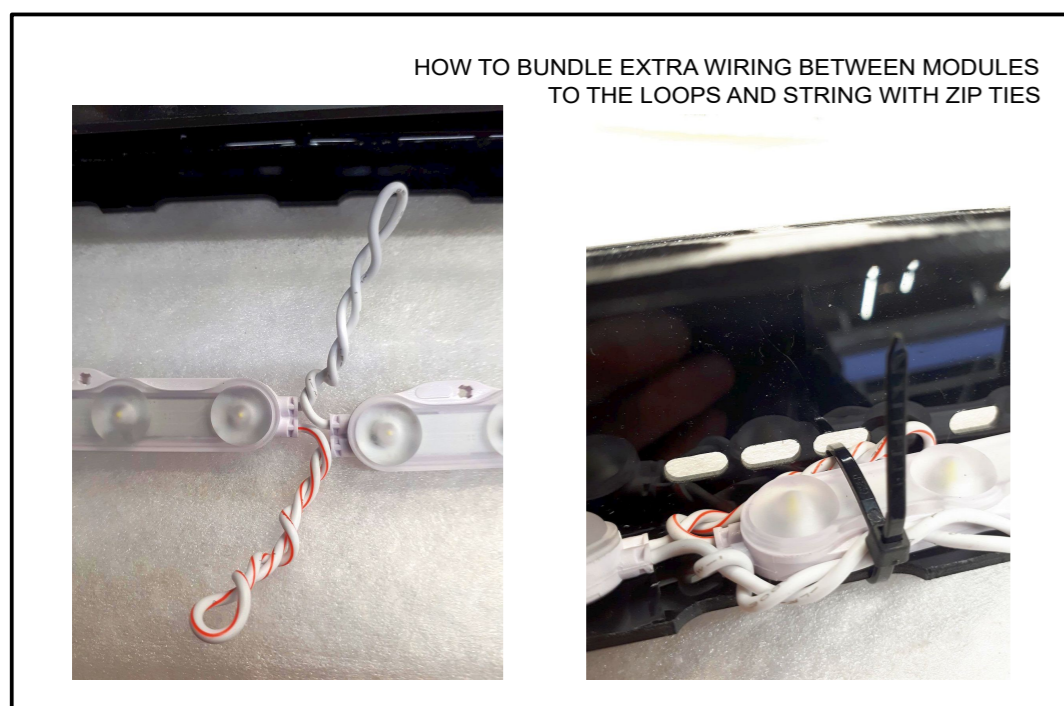

16.10.2023	PF	F8: 2004916; Added dimming feature, F9: Bilge halo dimming removed	Date	22.5.2019		Axopar	SEE EXP VIEW	29211	Project ID
15.03.2024	PF	G10:2005054; Added s15, S1 replaced with dimmer, test instruction update	Drawing by	TuM		Boat	Sub-product code	Product code	
17.2.2023	RK	F7: NOT MODIFIED.	Sheet rev.	10	Copyright by	37 MY20	SWITCH PANEL	Loc	93 / 213
Date of modification	Modified by	Description	Project rev.	G		Boat model	Title		Sheet

29211_AXOPAR_37_MY20_SWITCH_PANEL

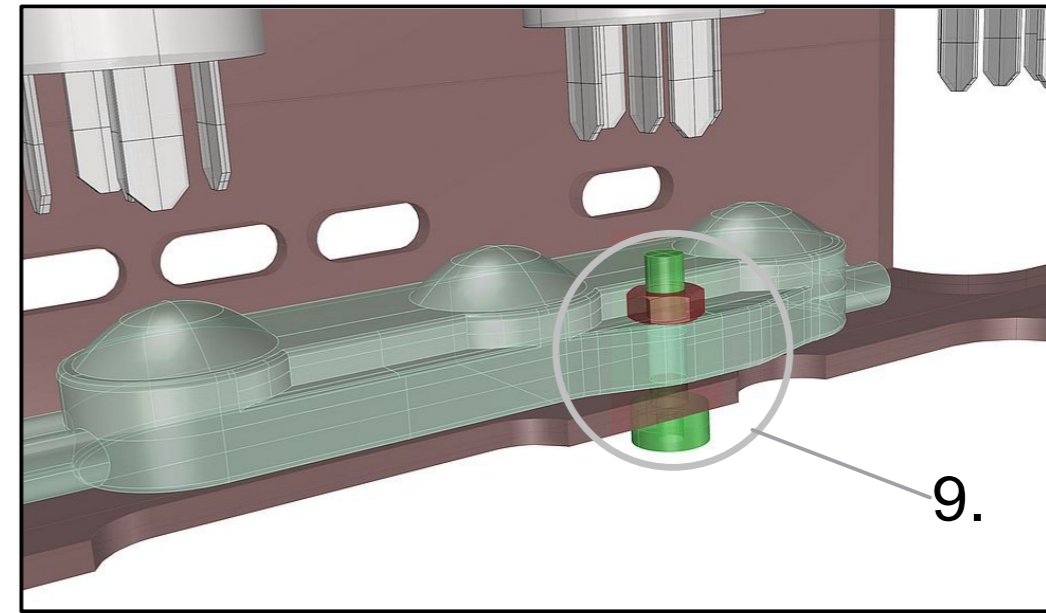
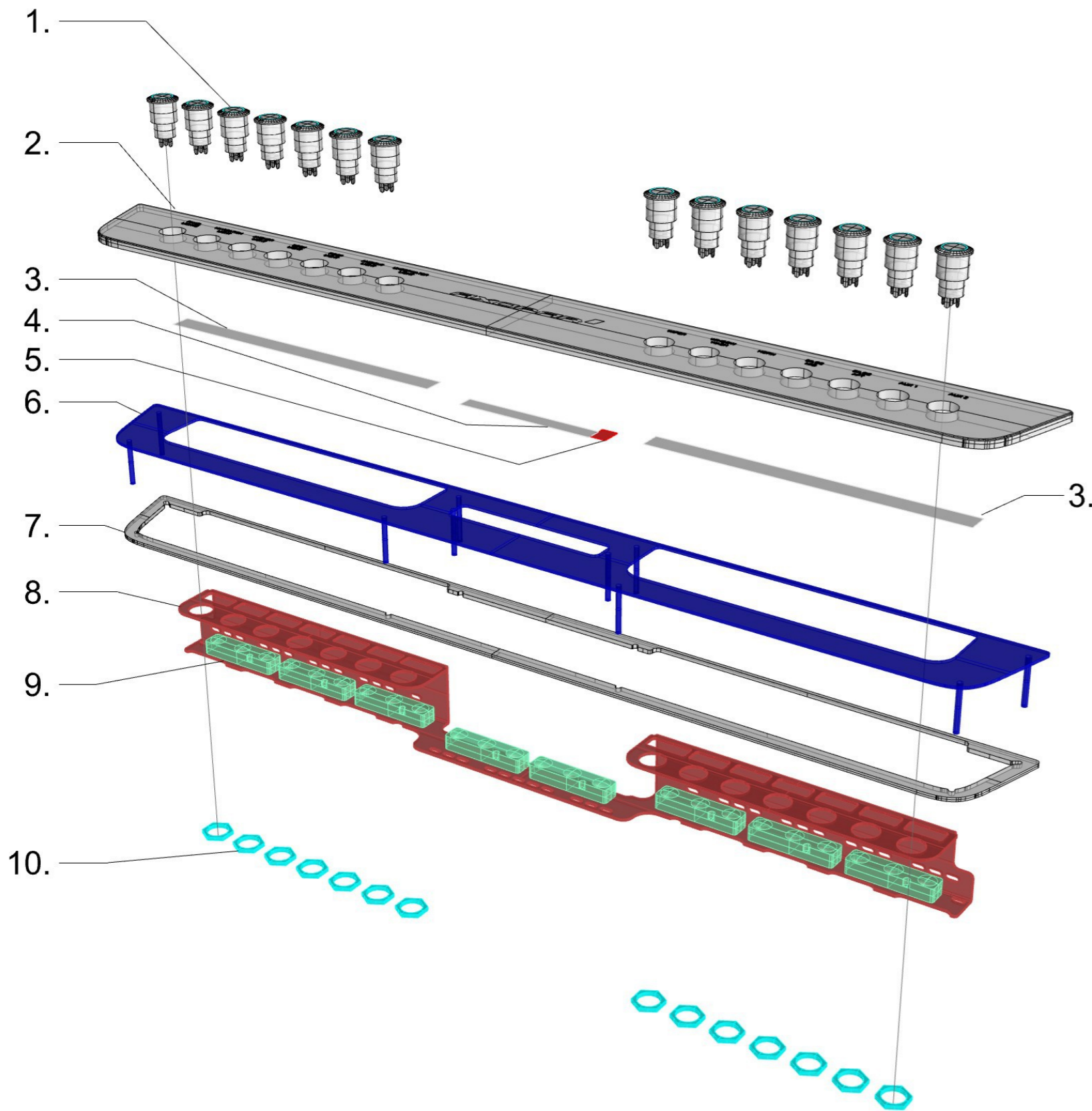

29211_AXOPAR_37_MY20_SWITCH_PANEL

1. 14PCS HALO SWITCH (AS IN DIAGRAM)
2. 1PCS 29767_AXOPAR_37_MY20_ACRYL_SWITCH_PANEL_(WOC)
3. 2PCS 29771_AXOPAR_37_MY20_SWITCH_PANEL_TEXT_STICKER (PLACE BEHIND THE TEXT AREA IN 29767)
4. 1PC 23722_AXOPAR_28_SWITCH_PANEL_LOGO_WHITE_STICKER (PLACE BEHIND THE TEXT AREA IN 29767)
5. 1PC 23723_AXOPAR_28_SWITCH_PANEL_LOGO_RED_STICKER (PLACE BEHIND THE TEXT AREA IN 29767)
6. 1PC 29768_AXOPAR_37_MY20_SWITCH_PANEL_METAL_BACK_FRAME ATTACH TO 29767 WITH BLACK MS-POLYMER GLUE
7. 1PC 29769_AXOPAR_37_MY20_SWITCH_PANEL_GASKET_(WOC) GLUE WITH 2-SIDED TAPE TO THE BACKSIDE OF 29768
8. 1PC 36371_AXOPAR_SWITCH_PANEL_LED_MODULE_BRACKET_(WOC)
9. 8PCS 16704 LED MODULE WHITE ATTATCH TO 36371 WITH M3X12 BH HEX BOLT A4 AND NUT ATTACH TO BRACKET WITH CABLE TIES AND 2-SIDED TAPE
10. 14PCS HALO SWITCH NUT

TE 20.05.2019
 TE 11.09.2019
 JSC 18.10.2019
 MN 18.11.2019
 TE 11.01.2022
 HL 11.03.2022

EXP VIEW

16.10.2023	PF	F8: 2004916; Added dimming feature, F9: Bilge halo dimming removed	Date	22.5.2019
15.03.2024	PF	G10:2005054; Added s15, S1 replaced with dimmer, test instruction update	Drawing by	TuM
17.2.2023	RK	F7: NOT MODIFIED.	Sheet rev.	10
Date of modification	Modified by	Description	Project rev.	G



Axopar	SEE EXP VIEW	29211	Project ID
Boat	Sub-product code	Product code	
37 MY20	SWITCH PANEL	HL	94 / 213 Sheet
Boat model	Title	Loc	

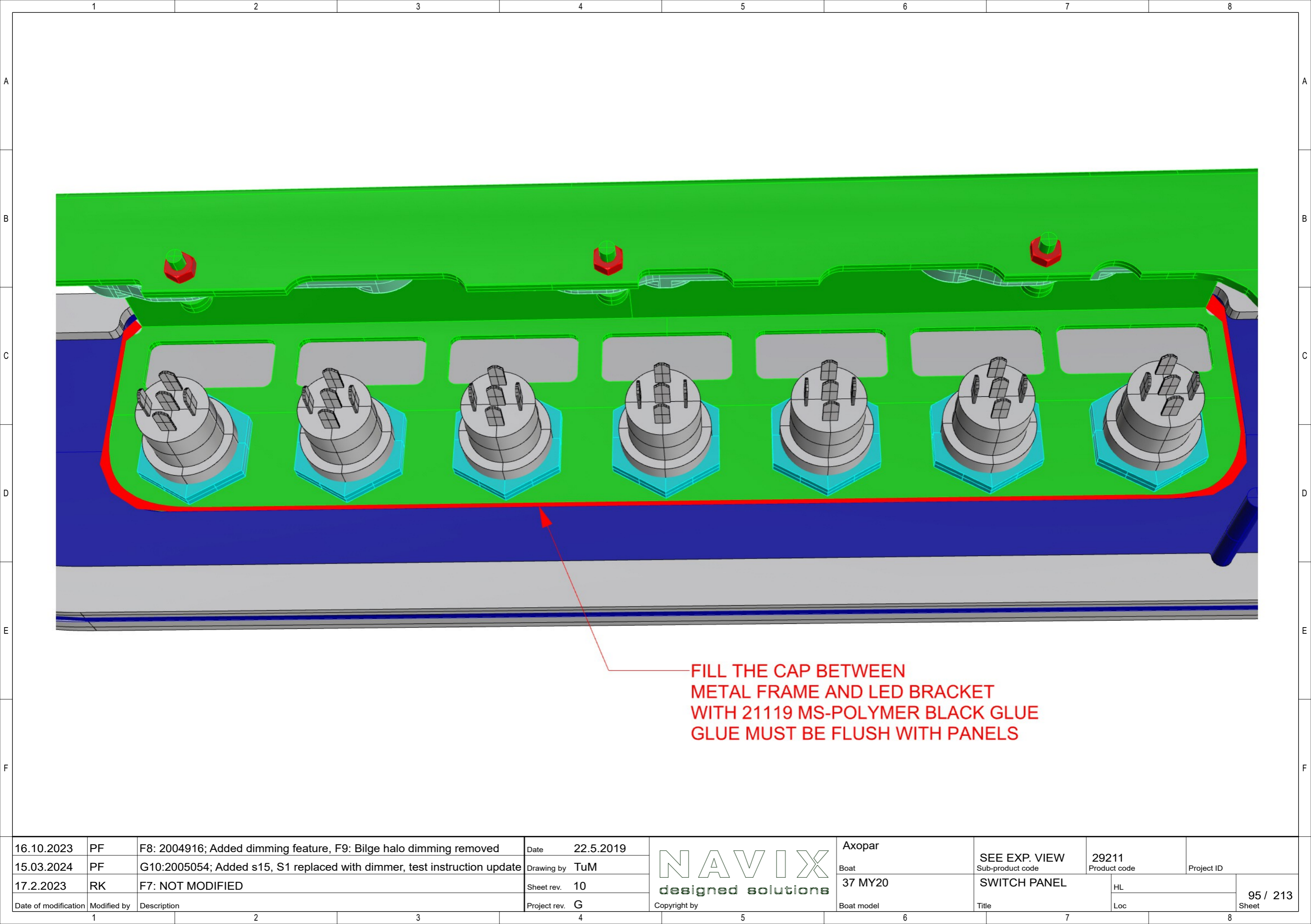

FILL THE GAP BETWEEN
 METAL FRAME AND LED BRACKET
 WITH 21119 MS-POLYMER BLACK GLUE
 GLUE MUST BE FLUSH WITH PANELS

16.10.2023	PF	F8: 2004916; Added dimming feature, F9: Bilge halo dimming removed	Date	22.5.2019	 NAVIX designed solutions Copyright by	Axopar	SEE EXP. VIEW	29211	Project ID
15.03.2024	PF	G10:2005054; Added s15, S1 replaced with dimmer, test instruction update	Drawing by	TuM		Boat	Sub-product code	Product code	
17.2.2023	RK	F7: NOT MODIFIED	Sheet rev.	10	37 MY20	SWITCH PANEL	HL	95 / 213	
Date of modification	Modified by	Description	Project rev.	G	Boat model	Title	Loc		Sheet

Axopar 37 MY20 SWITCH PANEL 29211 INSPECTION SHEET

PRUDUCT LABEL

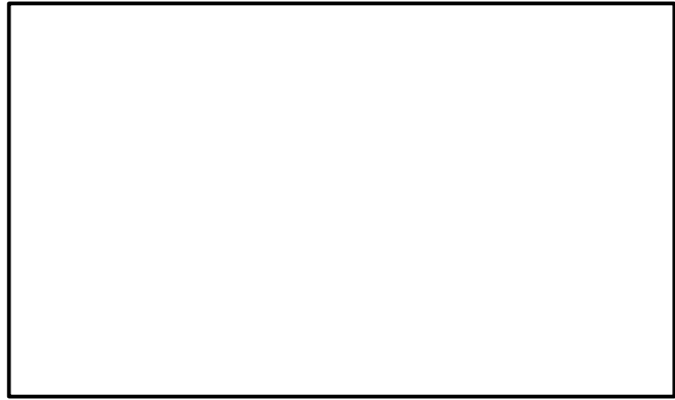

TEST

- 1) S2, S3, S4 should be pressed. No other buttons may be pressed during entire test. Power source off.
- 2) Connect -X.6b/9 and -X.7b/8 with a wire.
- 3) Connect positive (+12V) to connectors listed below
- 4) Connect negative (-) to -X.6b/10 and -X.7a/8. Turn power on.
- 5) Observe, change brightness and turn on/off by pressing DIM1. Panel lights and switch halos must illuminate. S11 and S12 should illuminate constantly with full brightness, all other lights should turn on/off/dim from DIM1.

Connect positive (+)	Connect negative (-)
X.6a/1	X.6b/10
X.6a/4	X.7a/8
X.6a/7	
X.6b/6	
X.6b/7	
X.6b/8	
X.7a/7	
X.7b/7	
X.7a/5	
X.7b/2	
X.7b/5	
X.7c/5	
X.7c/6	
X.7d/4	

PASS / FAIL

DATE

TESTED BY

TEST INSTRUCTIONS

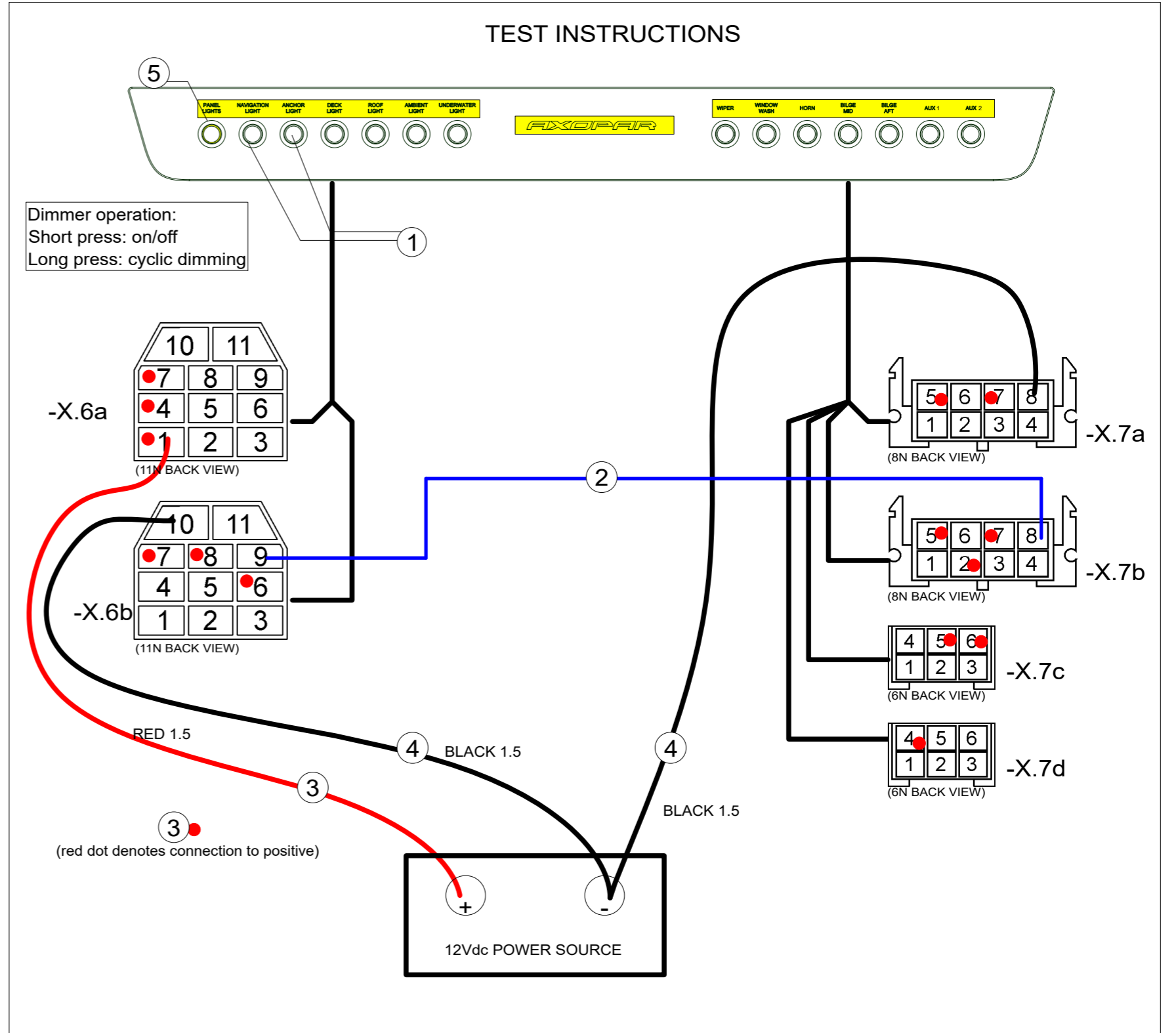

16.10.2023	PF	F8: 2004916; Added dimming feature, F9: Bilge halo dimming removed	Date	22.5.2019
15.03.2024	PF	G10:2005054; Added s15, S1 replaced with dimmer, test instruction update	Drawing by	TuM
17.2.2023	RK	F7: NOT MODIFIED.	Sheet rev.	10
Date of modification	Modified by	Description	Project rev.	G



Axopar	SEE EXP VIEW	29211	Project ID
Boat	Sub-product code	Product code	
37 MY20	SWITCH PANEL	HL	96 / 213
Boat model	Title	Loc	Sheet

HARNESS GENERAL LAYOUT

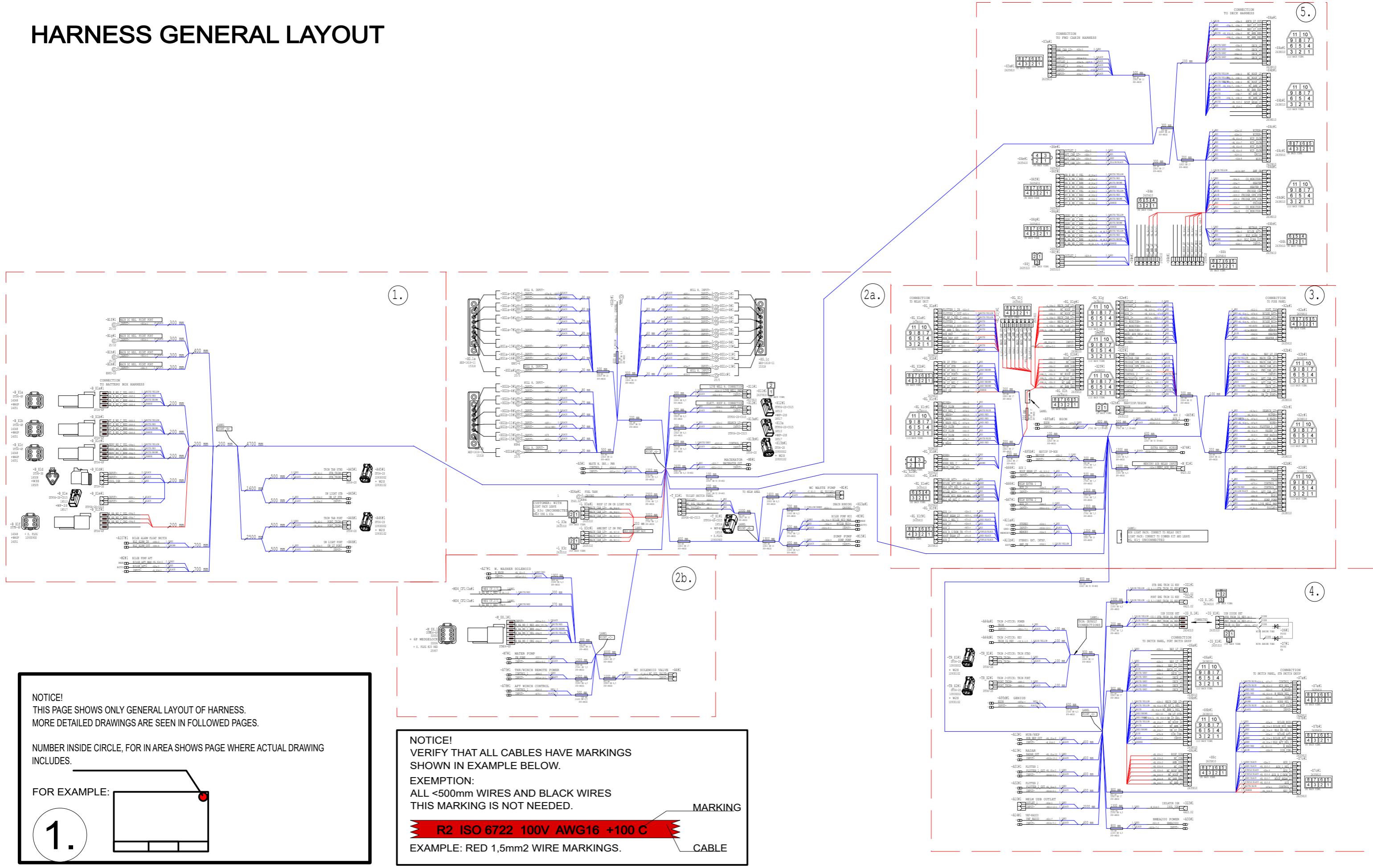

NOTICE!
THIS PAGE SHOWS ONLY GENERAL LAYOUT OF HARNESS.
MORE DETAILED DRAWINGS ARE SEEN IN FOLLOWED PAGES.

NUMBER INSIDE CIRCLE, FOR IN AREA SHOWS PAGE WHERE ACTUAL DRAWING INCLUDES.

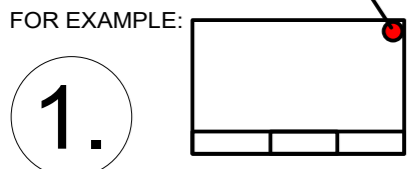

NOTICE!
VERIFY THAT ALL CABLES HAVE MARKINGS SHOWN IN EXAMPLE BELOW.

EXEMPTION:
ALL <500mm WIRES AND BLACK WIRES
THIS MARKING IS NOT NEEDED.



16.10.2023	PF	F11: 2004916; Added X4j & DIM_COM- wire
11.3.2024	PF	G12: 2005054; Added/mod connections to deck h., rel. unit, lt switches, swp
17.2.2023	RK	F10: SEVERAL MODIFICATIONS.
Date of modification	Modified by	Description

Date	20.5.2019
Drawing by	TuM
Sheet rev.	12
Project rev.	G

NAVIX
designed solutions
Copyright by

Axopar
Boat
37 MY20
Boat model

Sub-product code	29585	Product code	Project ID
HULL HARNESS		HL	97 / 213
Title	Loc	Sheet	

NOTICE! CABLES WITH STICKER

FOR EXAMPLE
POINT -A-

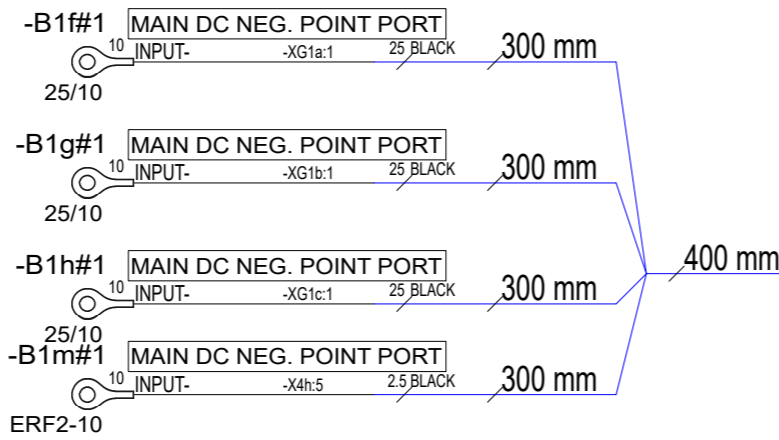

CONNECTION
TO BATTERY BOX HARNESS

-B_X1a#1

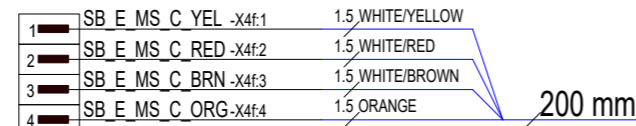

-B_X1b#1

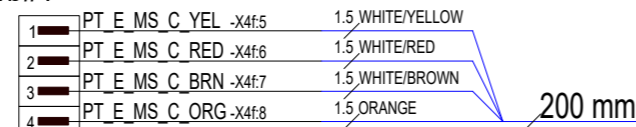

-B_X1c#1

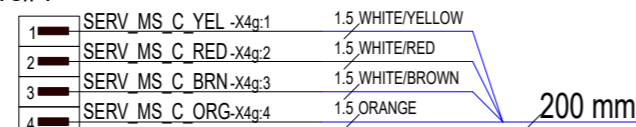

-B_X1d#1

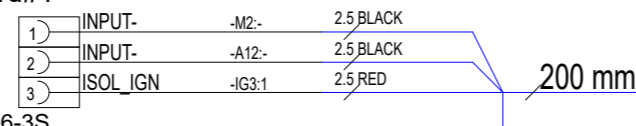

-B_X1e#1

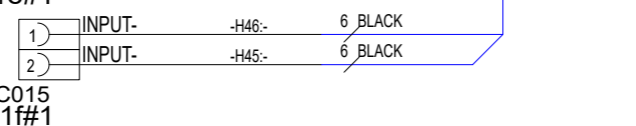

-B_X1f#1

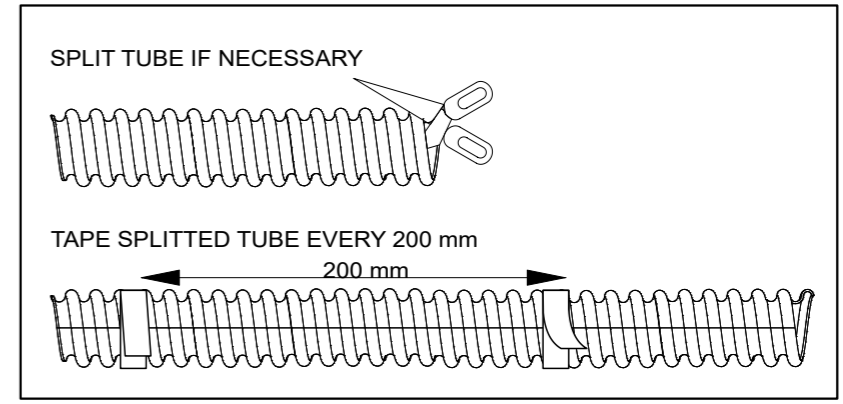
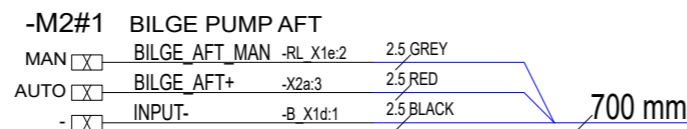
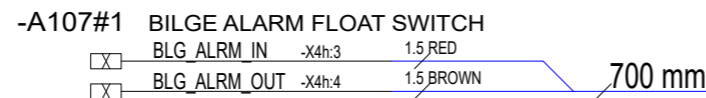
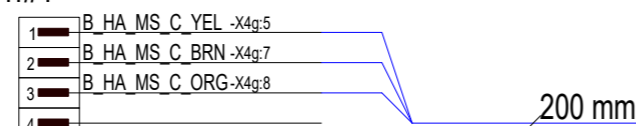

1.

DELIVERED SEPARATELY

-A.45a & -A.46a
2 PCS DT04-2P
16461
+ 2PCS WEDGELOCK: W2P
16467
+ 4 PCS DLU 10931852

- B_X1a
DT04-4P
14048
+W4P
14051
- B_X1b
DT04-4P
14048
+W4P
14051
- B_X1c
DT04-4P
14048
+W4P
14051
- B_X1d
DT06-3S
18508
+W3S
18509
- B_X1e
DTP06-2S-C015
18513
+WP-2S
18517
- B_X1f
DT04-4P
14048 + S. PLUG
+W4P 10930900
14051

LABEL
POINT -B-

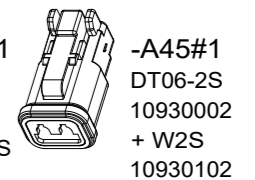
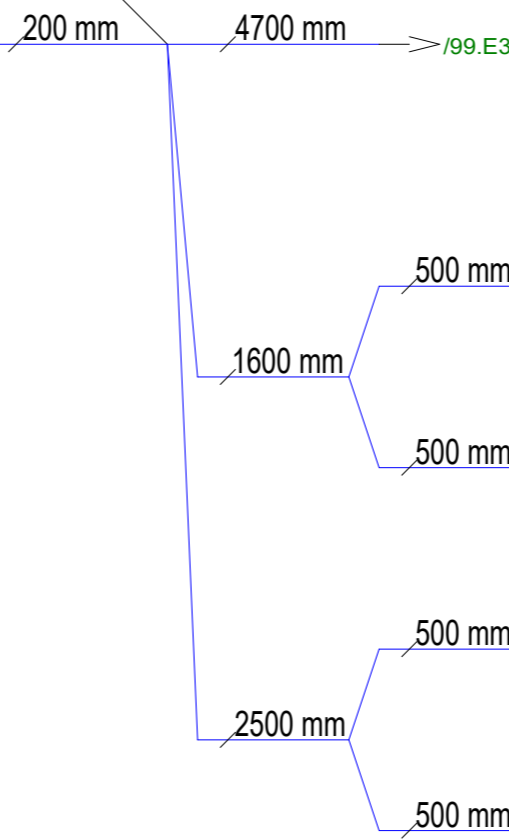

16.10.2023	PF	F11: 2004916; Added X4j & DIM_COM- wire	Date	20.5.2019
11.3.2024	PF	G12: 2005054; Added/mod connections to deck h., rel. unit, lt switches, swp	Drawing by	TuM
17.2.2023	RK	F10: SEVERAL MODIFICATIONS.	Sheet rev.	12
Date of modification	Modified by	Description	Project rev.	G



Axopar	Boat	37 MY20	Sub-product code	HULL HARNESS	29585	Product code	Project ID	98 / 213
	Boat model		Title		HL	Loc		Sheet

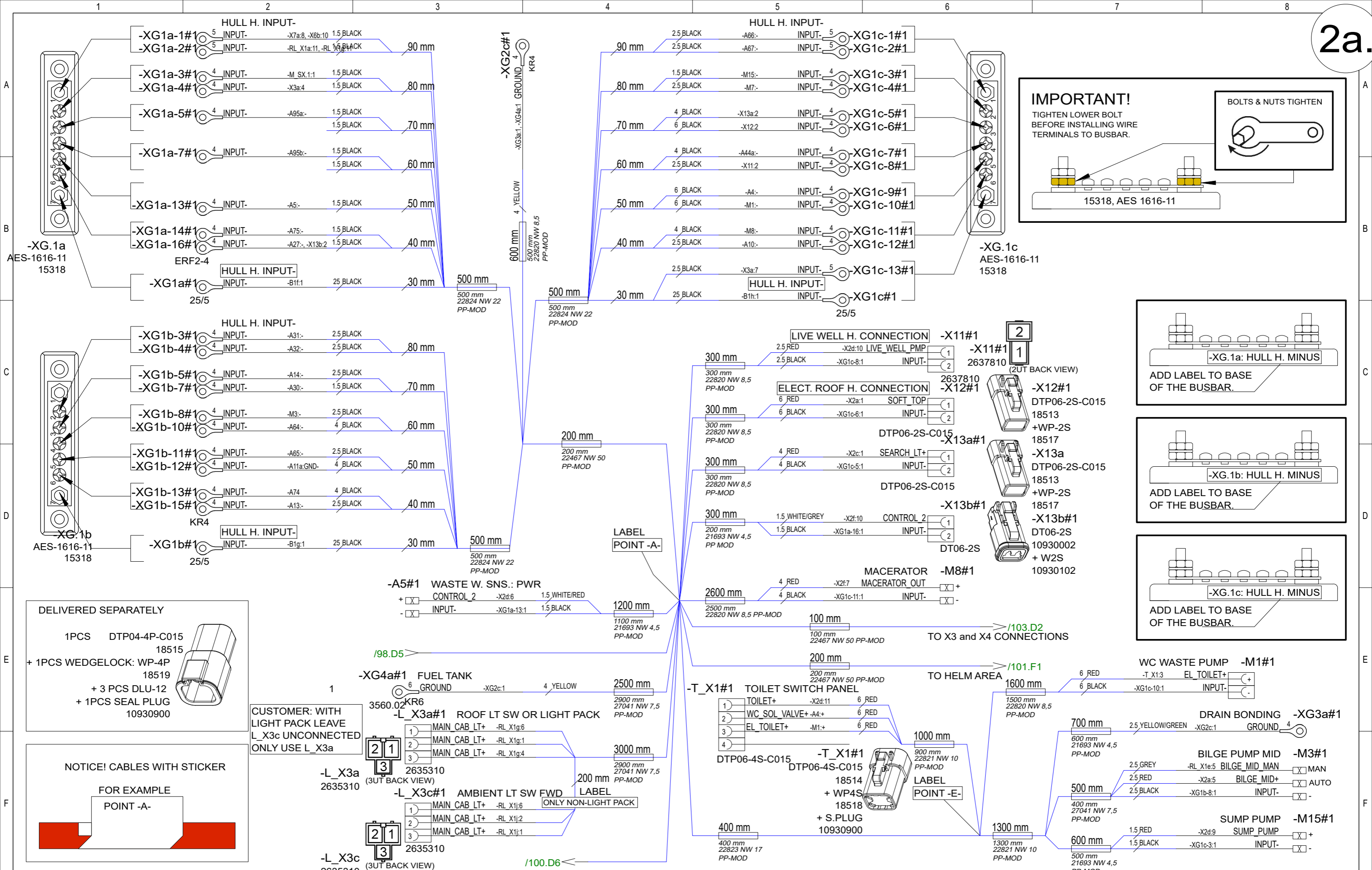

IMPORTANT!
TIGHTEN LOWER BOLT BEFORE INSTALLING WIRE TERMINALS TO BUSBAR.

BOLTS & NUTS TIGHTEN

15318, AES 1616-11

-XG.1a: HULL H. MINUS

ADD LABEL TO BASE OF THE BUSBAR.

-XG.1b: HULL H. MINUS

ADD LABEL TO BASE OF THE BUSBAR.

-XG.1c: HULL H. MINUS

ADD LABEL TO BASE OF THE BUSBAR.

DELIVERED SEPARATELY

1PCS DTP04-4P-C015 18515
+ 1PCS WEDGELOCK: WP-4P 18519
+ 3 PCS DLU-12
+ 1PCS SEAL PLUG 10930900

NOTICE! CABLES WITH STICKER

FOR EXAMPLE POINT -A-

CUSTOMER: WITH LIGHT PACK LEAVE L_X3c UNCONNECTED ONLY USE L_X3a

16.10.2023	PF	F11: 2004916; Added X4j & DIM_COM- wire	Date	20.5.2019
11.3.2024	PF	G12: 2005054; Added/mod connections to deck h., rel. unit, lt switches, swp	Drawing by	TuM
17.2.2023	RK	F10: SEVERAL MODIFICATIONS.	Sheet rev.	12
Date of modification	Modified by	Description	Project rev.	G



Axopar	Boat	37 MY20	Sub-product code	HULL HARNESS	Project ID	29585
	Boat model		Title		HL	99 / 213
					Loc	Sheet

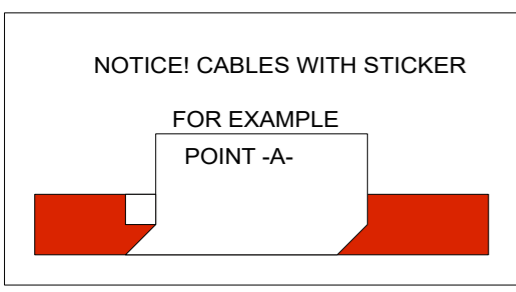
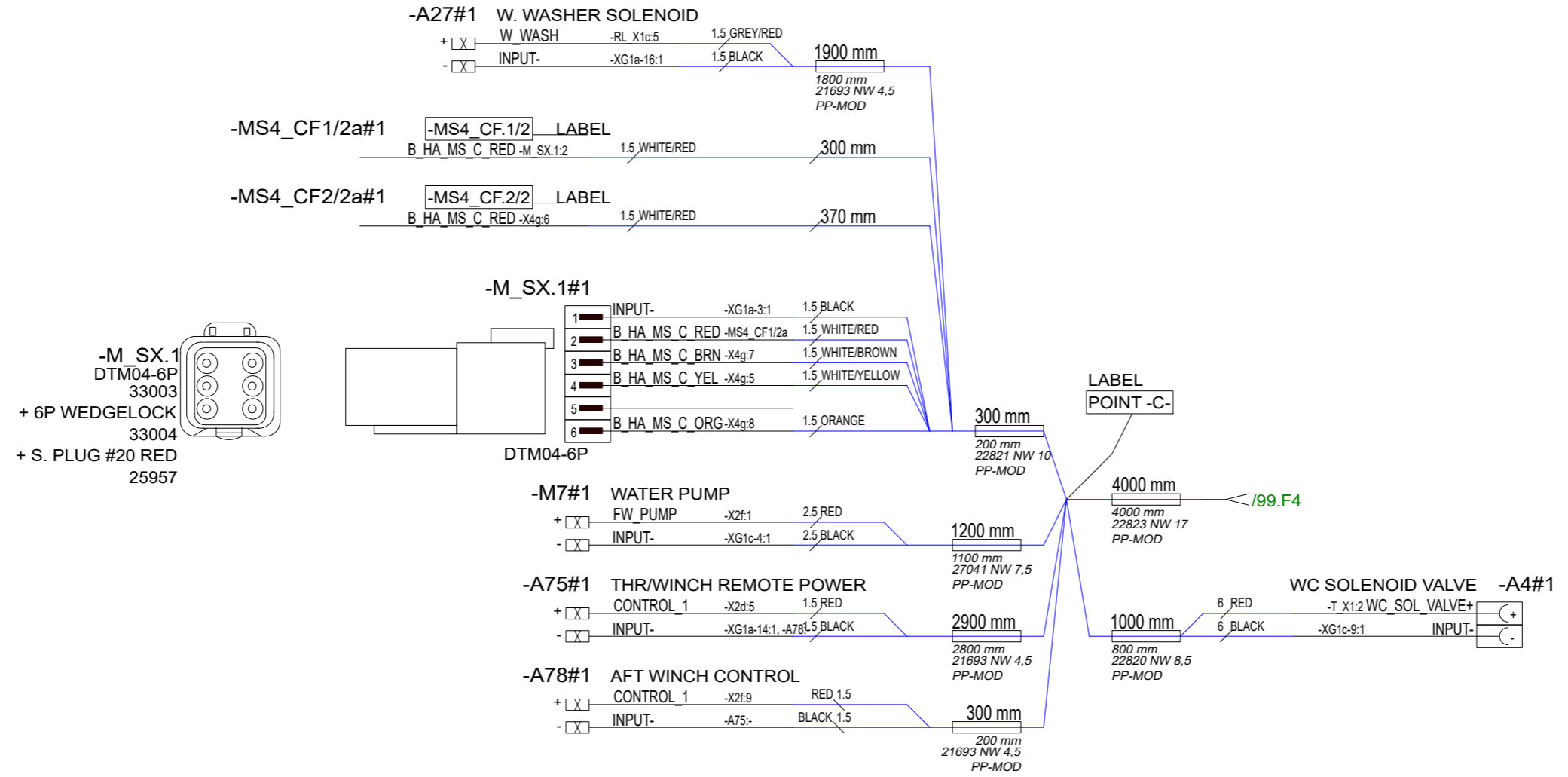
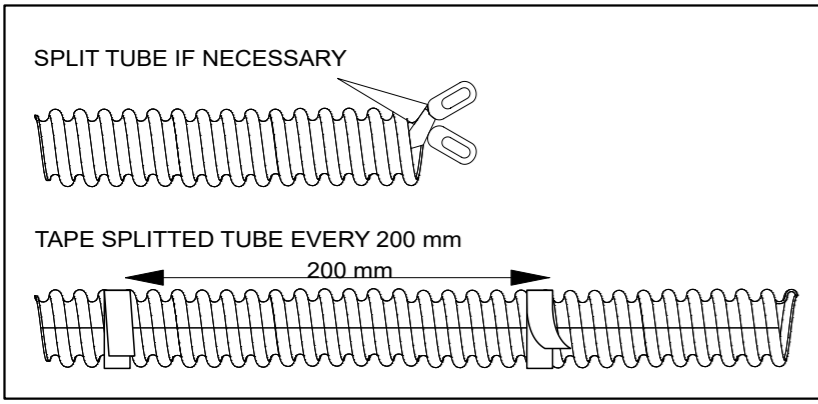

16.10.2023	PF	F11: 2004916; Added X4j & DIM_COM- wire	Date	31.08.2020
11.3.2024	PF	G12: 2005054; Added/mod connections to deck h., rel. unit, lt switches, swp	Drawing by	TuM
17.2.2023	RK	F10: SEVERAL MODIFICATIONS.	Sheet rev.	12
Date of modification	Modified by	Description	Project rev.	G



Axopar	29585	Project ID
Boat	37 MY20	HULL HARNESS
Boat model	Title	HL
		Loc
		100 / 213 Sheet

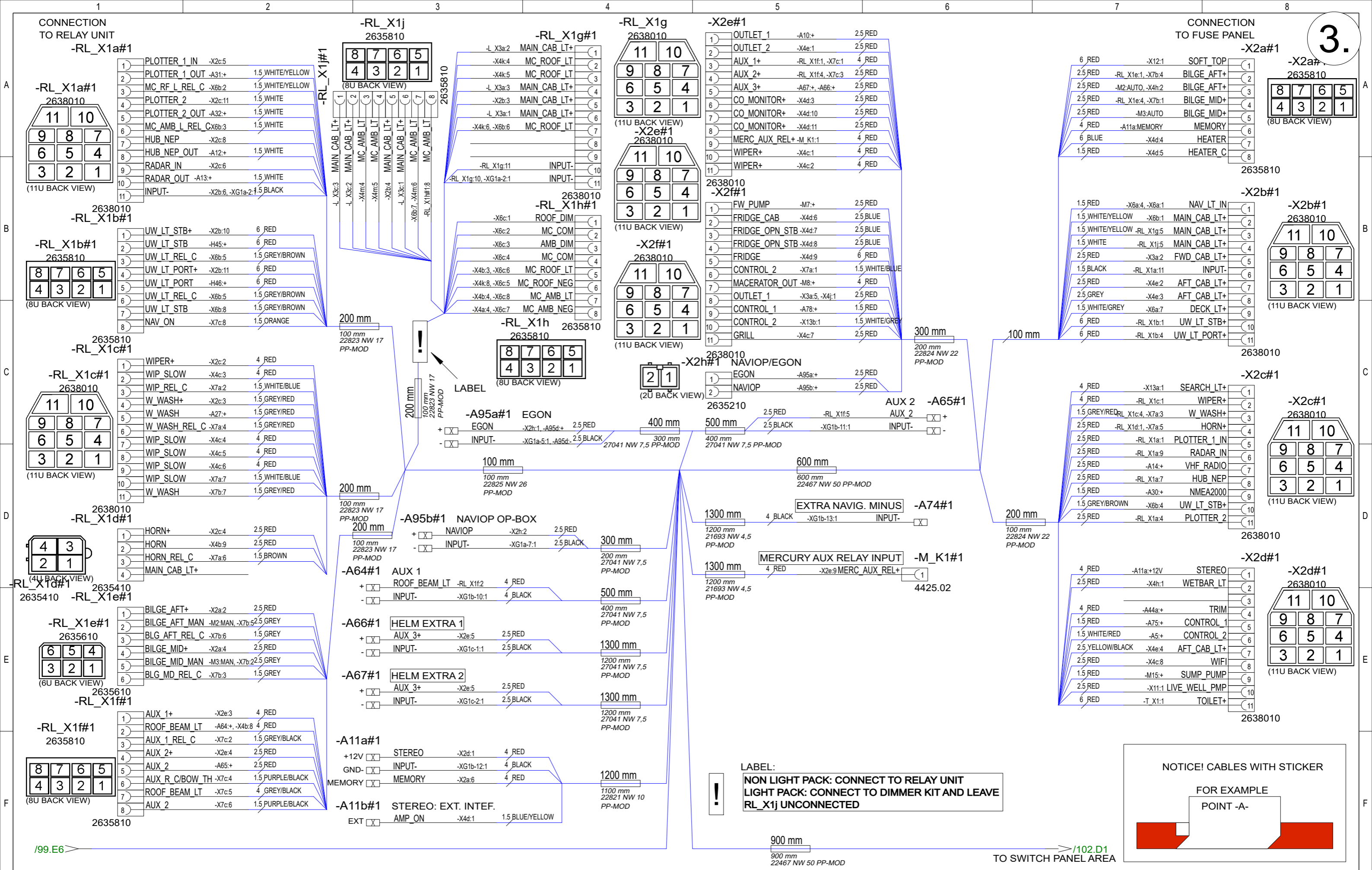

16.10.2023	PF	F11: 2004916; Added X4j & DIM_COM- wire	Date	20.5.2019
11.3.2024	PF	G12: 2005054; Added/mod connections to deck h., rel. unit, lt switches, swp	Drawing by	TuM
17.2.2023	RK	F10: SEVERAL MODIFICATIONS.	Sheet rev.	12
Date of modification	Modified by	Description	Project rev.	G

		Axopar	
		Boat	37 MY20
Copyright by		Sub-product code	29585
		Title	HULL HARNESS
		Product code	HL
		Loc	101/ 213
		Project ID	Sheet

DELIVERED SEPARATELY
 2PCS DT04-2P
 16461
 + 2PCS WEDGELOCK: W2P
 16467
 + 4 PCS DLU 10931852

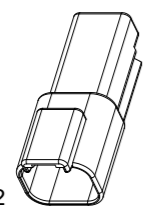
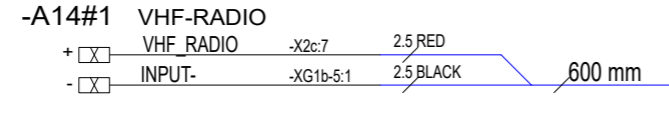
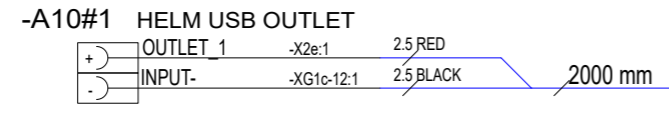
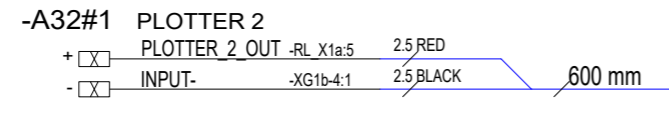
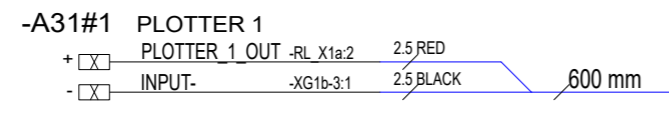
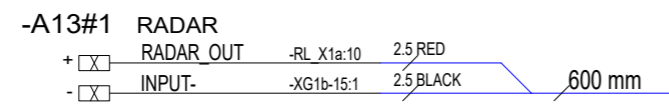
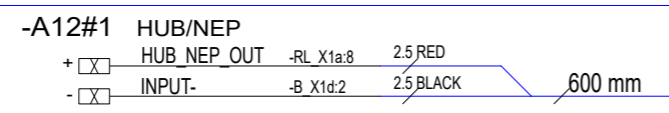
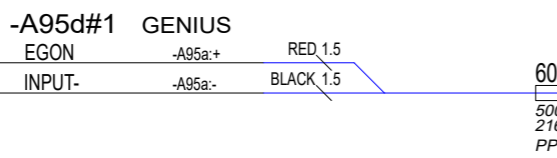
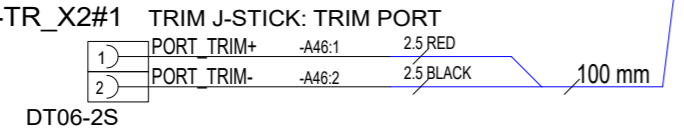
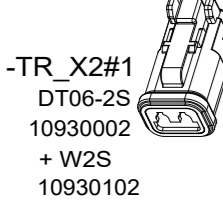
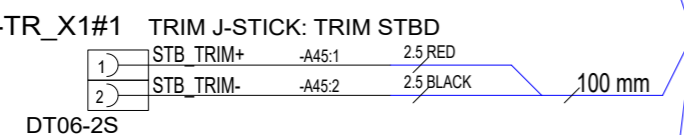
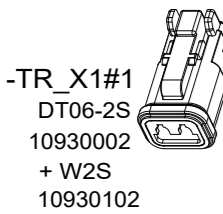
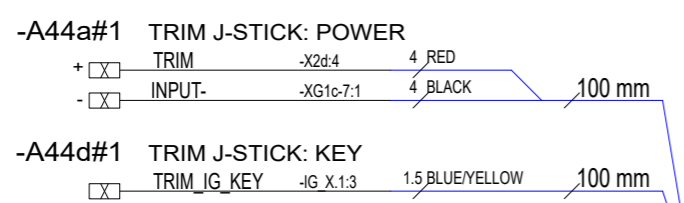



NOTICE! CABLES WITH STICKER
 FOR EXAMPLE
 POINT -A-

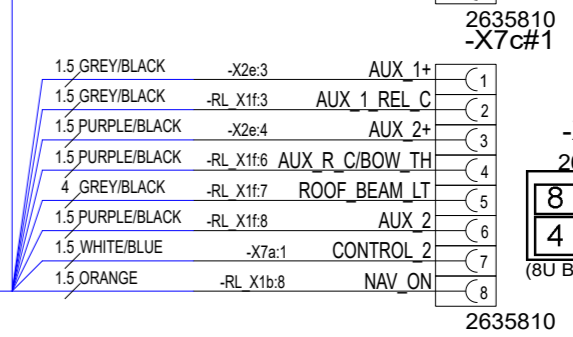
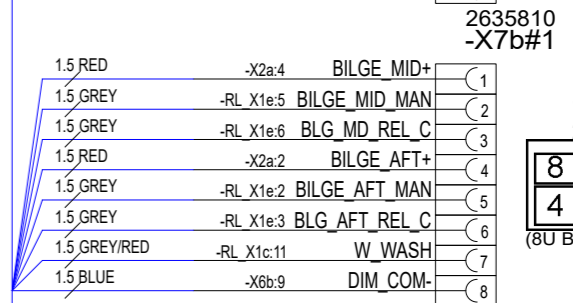
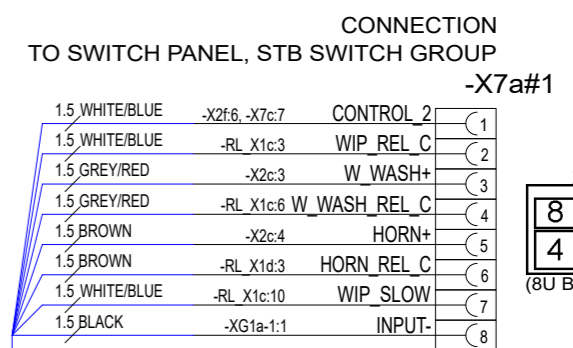
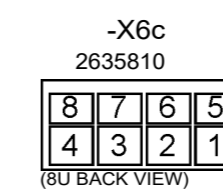
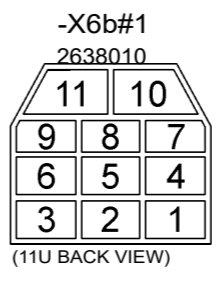
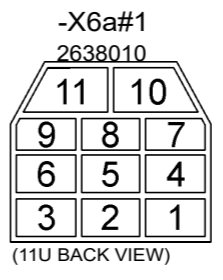
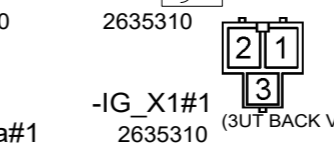
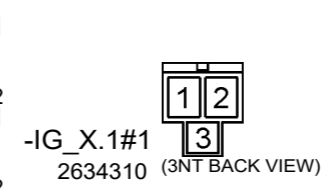
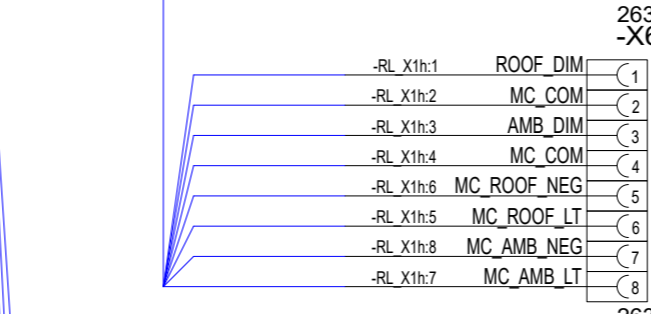
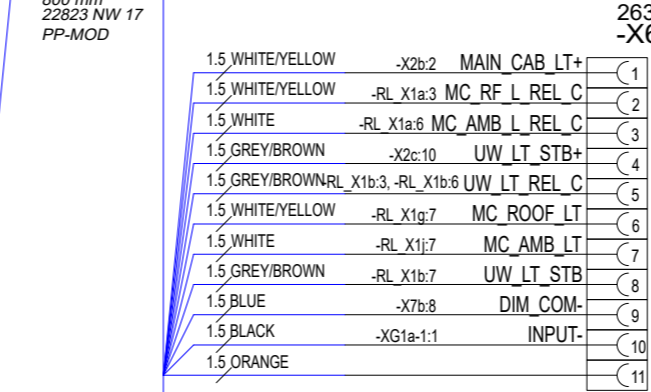
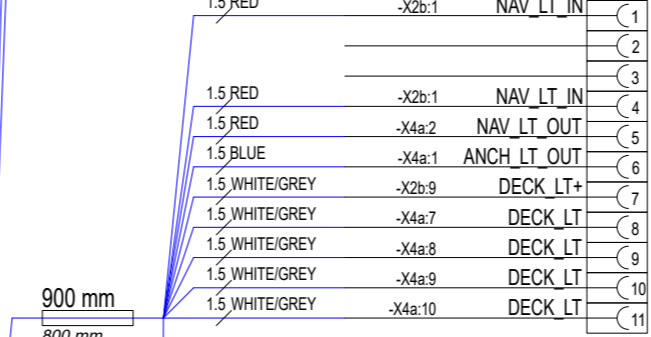
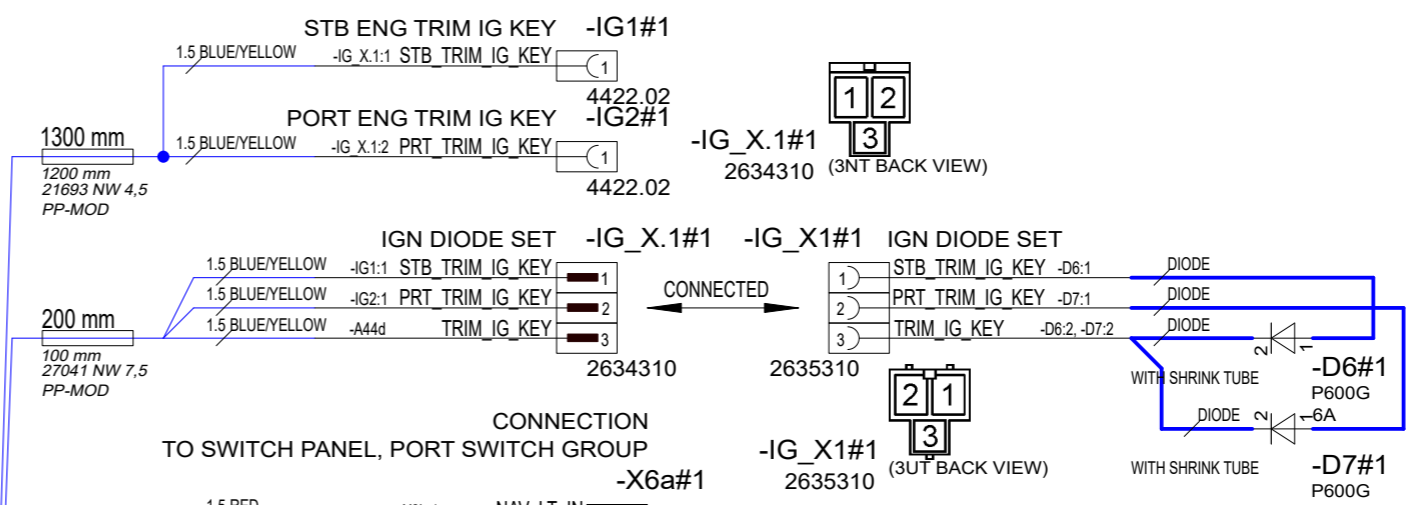

LABEL:
 TRIM: DEFAULT
 CONNECTIONS

LABEL
 POINT -D-



16.10.2023	PF	F11: 2004916; Added X4j & DIM_COM- wire	Date	20.5.2019
11.3.2024	PF	G12: 2005054; Added/mod connections to deck h., rel. unit, lt switches, swp	Drawing by	TuM
17.2.2023	RK	F10: SEVERAL MODIFICATIONS.	Sheet rev.	12
Date of modification	Modified by	Description	Project rev.	G

NAVIX
 designed solutions

Axopar
 Boat 37 MY20
 Boat model

29585
 Sub-product code
 HULL HARNESS
 Title

Product code
 HL
 Loc

Project ID
 102 / 213
 Sheet

CONNECTION TO DECK HARNESS

CONNECTION TO FWD CABIN HARNESS

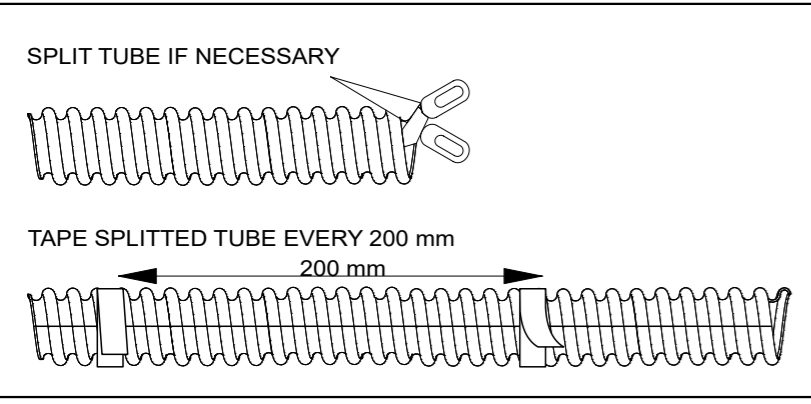
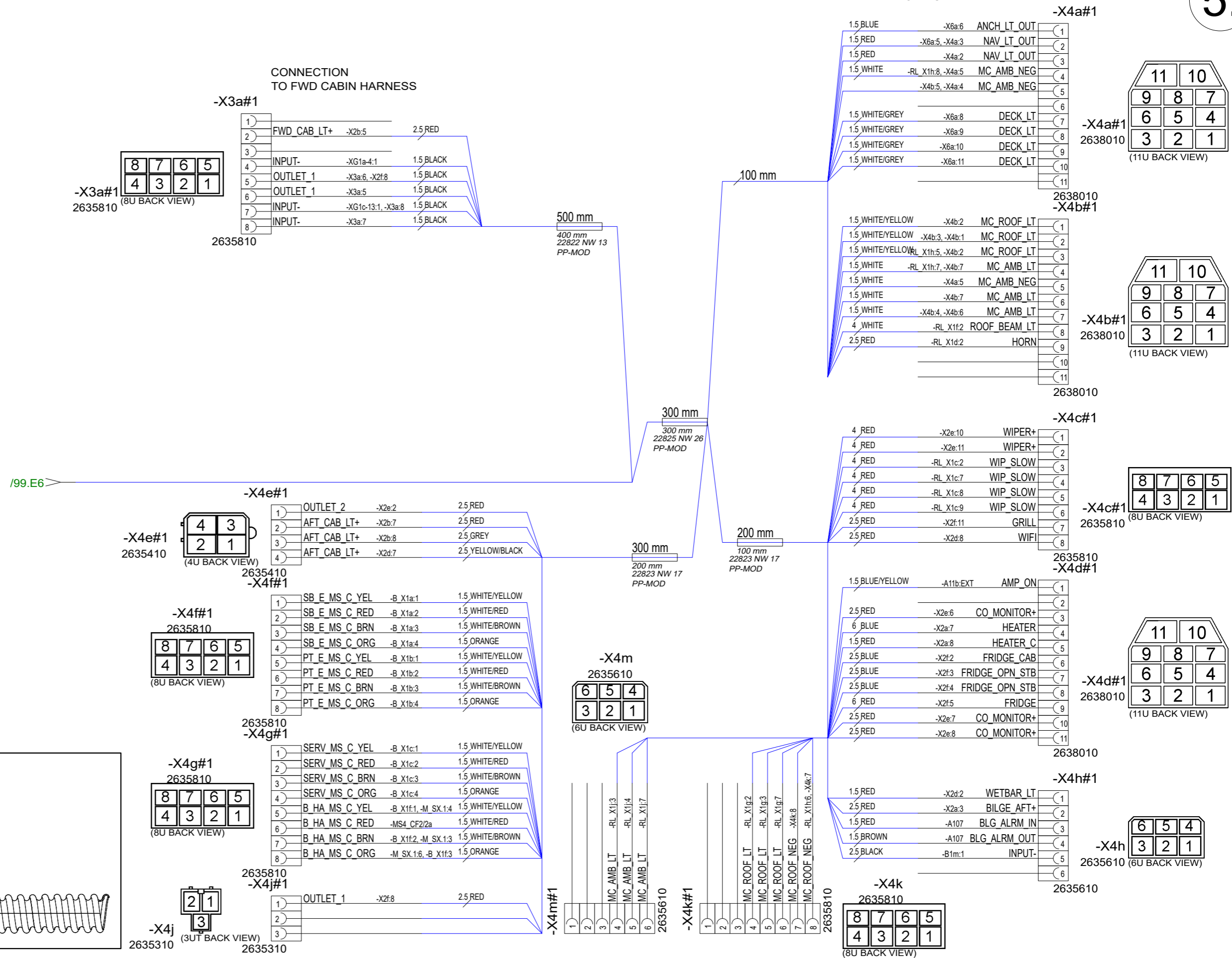

16.10.2023	PF	F11: 2004916; Added X4j & DIM_COM- wire	Date	20.5.2019	 designed solutions	Axopar					
11.3.2024	PF	G12: 2005054; Added/mod connections to deck h., rel. unit, lt switches, swp	Drawing by	TuM		Boat	37 MY20	Sub-product code	29585	Product code	Project ID
17.2.2023	RK	F10: SEVERAL MODIFICATIONS.	Sheet rev.	12		Boat model		HULL HARNESS	HL		103 / 213
Date of modification	Modified by	Description	Project rev.	G	Copyright by		Title	Loc		Sheet	

HARNES GENERAL LAYOUT

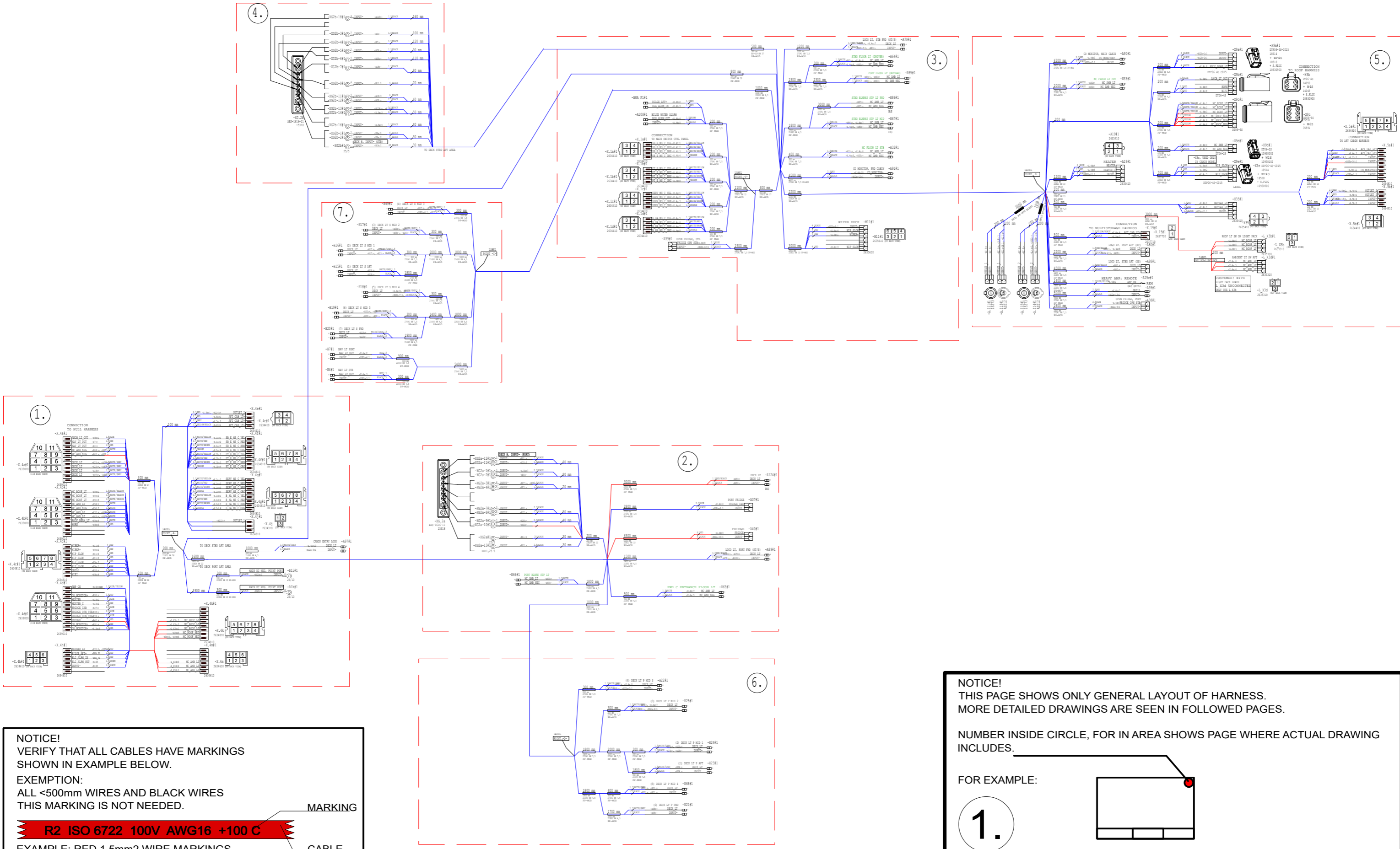

NOTICE!
 VERIFY THAT ALL CABLES HAVE MARKINGS SHOWN IN EXAMPLE BELOW.
EXEMPTION:
 ALL <500mm WIRES AND BLACK WIRES THIS MARKING IS NOT NEEDED.

MARKING
CABLE

R2 ISO 6722 100V AWG16 +100 C
 EXAMPLE: RED 1,5mm² WIRE MARKINGS.

NOTICE!
 THIS PAGE SHOWS ONLY GENERAL LAYOUT OF HARNES.
 MORE DETAILED DRAWINGS ARE SEEN IN FOLLOWED PAGES.

NUMBER INSIDE CIRCLE, FOR IN AREA SHOWS PAGE WHERE ACTUAL DRAWING INCLUDES.

FOR EXAMPLE:

1.

16.10.2023	TT	F10; 2004916; Added outlets A111-A114 & X4j	Date	20.5.2019		Axopar			
11.3.2024	PF	G11: 2005054; Logo It supply to deck It, flir, light pack	Drawing by	TuM		Boat	29586		
17.2.2023	RK	F9: SEVERAL MODIFICATIONS	Sheet rev.	11		37 MY20	Product code	HL	Project ID
Date of modification	Modified by	Description	Project rev.	G	Boat model	Title	Loc	104 / 213 Sheet	

NOTICE! CABLES WITH STICKER
FOR EXAMPLE
POINT -A-

CONNECTION TO HULL HARNESS

-X.4a#1

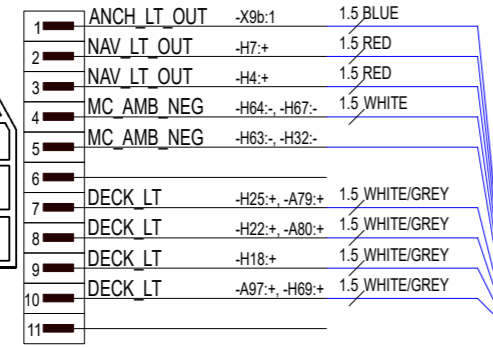

-X.4a#1
2639010

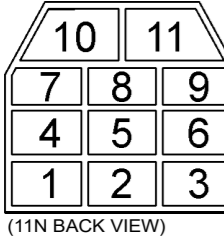

2639010
-X.4b#1

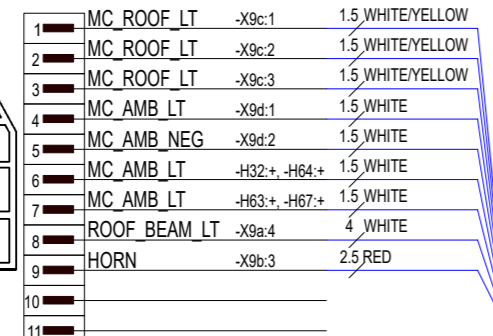

-X.4b#1
2639010

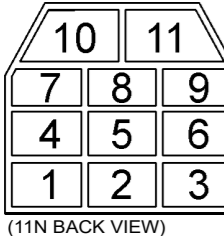

2639010
-X.4c#1

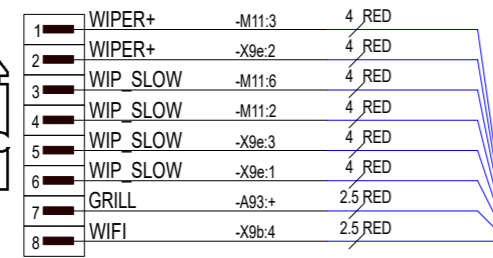

-X.4c#1
2634810

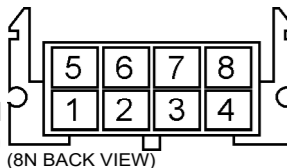

2634810
-X.4d#1

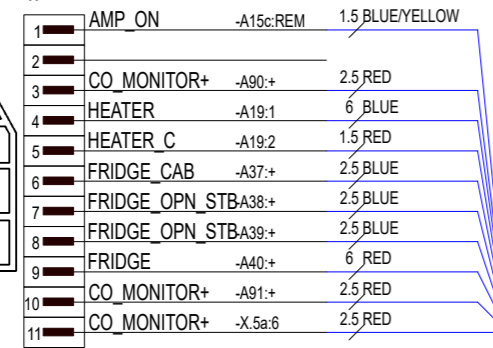

-X.4d#1
2639010

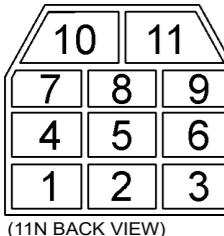

2639010

-X.4h#1

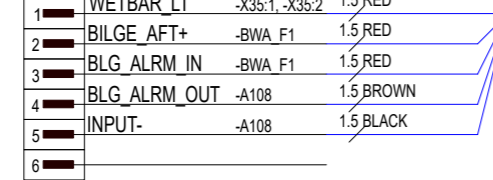

-X.4h#1
2634610

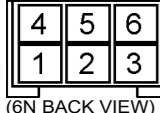

2634610

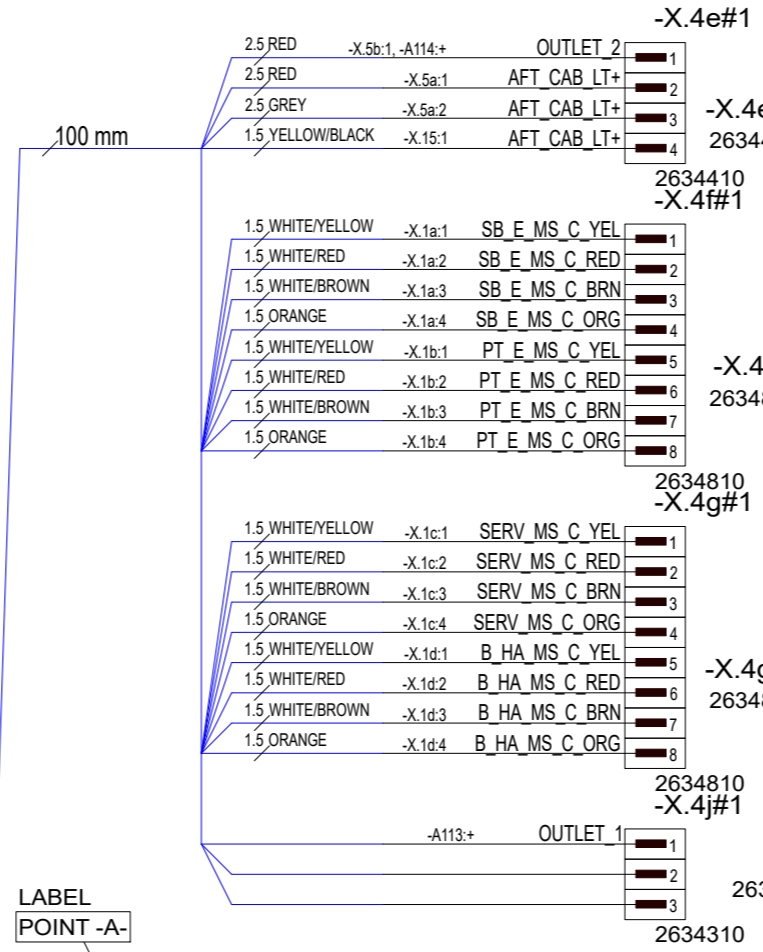

LABEL POINT -A-

TO DECK STBD AFT AREA

TO DECK PORT AFT AREA

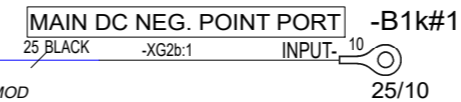
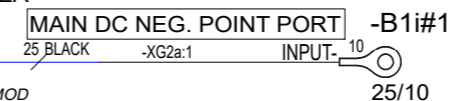

-X.4k#1

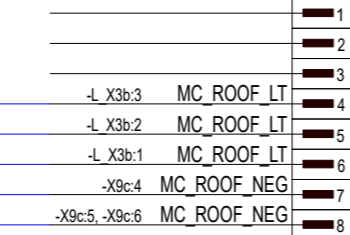

-X.4k
2634810

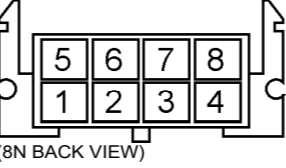

2634810
-X.4m#1

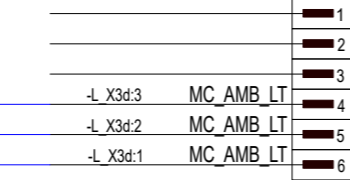

-X.4m
2634610



2634610

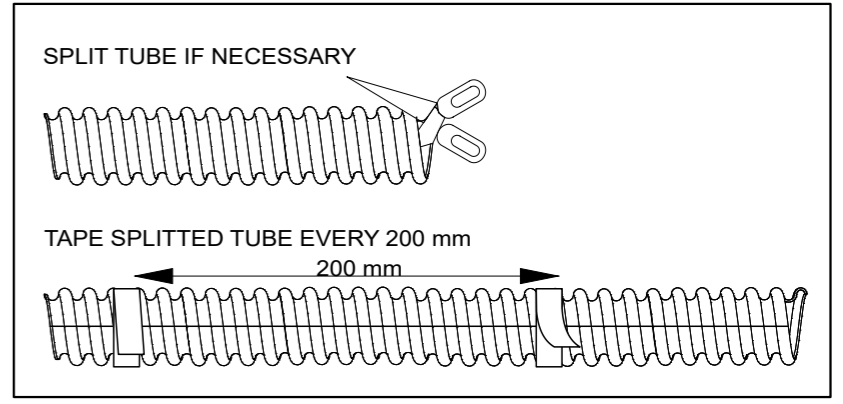

16.10.2023	TT	F10; 2004916; Added outlets A111-A114 & X4j
11.3.2024	PF	G11: 2005054; Logo It supply to deck lt, flir, light pack
17.2.2023	RK	F9: SEVERAL MODIFICATIONS
Date of modification	Modified by	Description

Date	17.5.2019
Drawing by	TuM
Sheet rev.	11
Project rev.	G



Axopar
Boat
37 MY20
Boat model

Sub-product code	29586	Product code	Project ID
DECK HARNESS		HL	105 / 213
Title	Loc	Sheet	

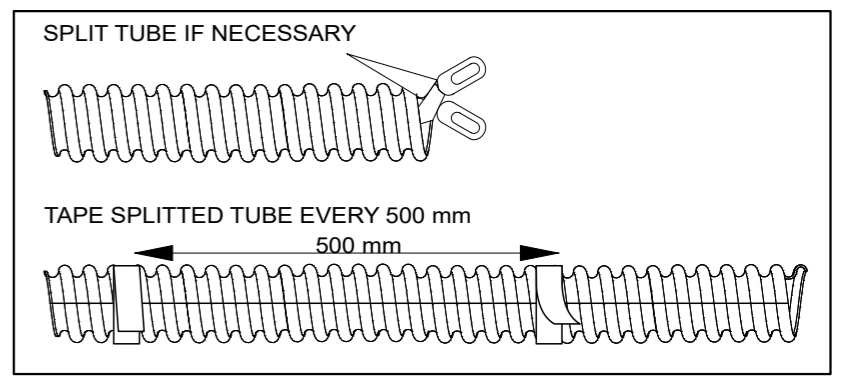
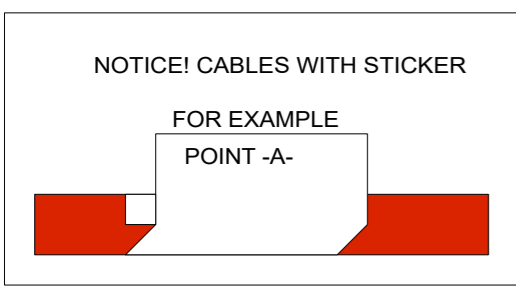
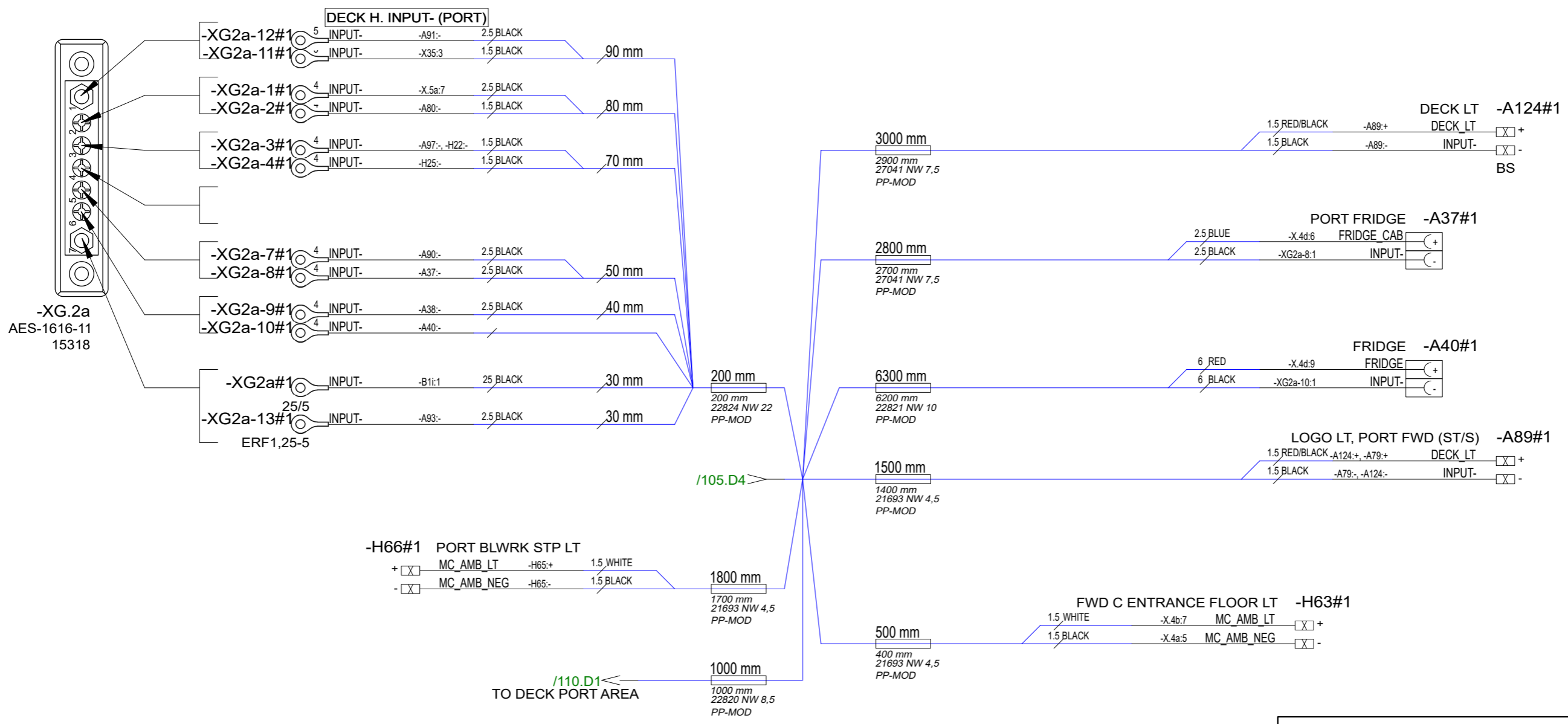
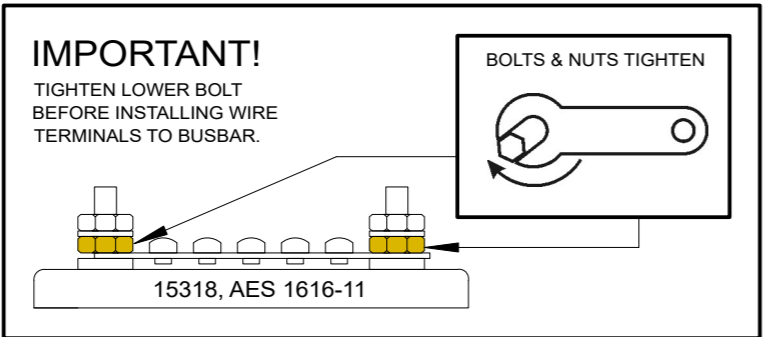
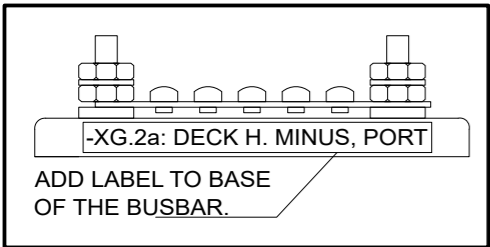

16.10.2023	TT	F10; 2004916; Added outlets A111-A114 & X4j	Date	17.5.2019		Axopar					
11.3.2024	PF	G11: 2005054; Logo It supply to deck lt, flir, light pack	Drawing by	TuM		Boat	37 MY20	Sub-product code	29586	Product code	Project ID
17.2.2023	RK	F9: SEVERAL MODIFICATIONS	Sheet rev.	11		Boat model		DECK HARNESS	HL		106 / 213
Date of modification	Modified by	Description	Project rev.	G	Copyright by		Title	Loc		Sheet	

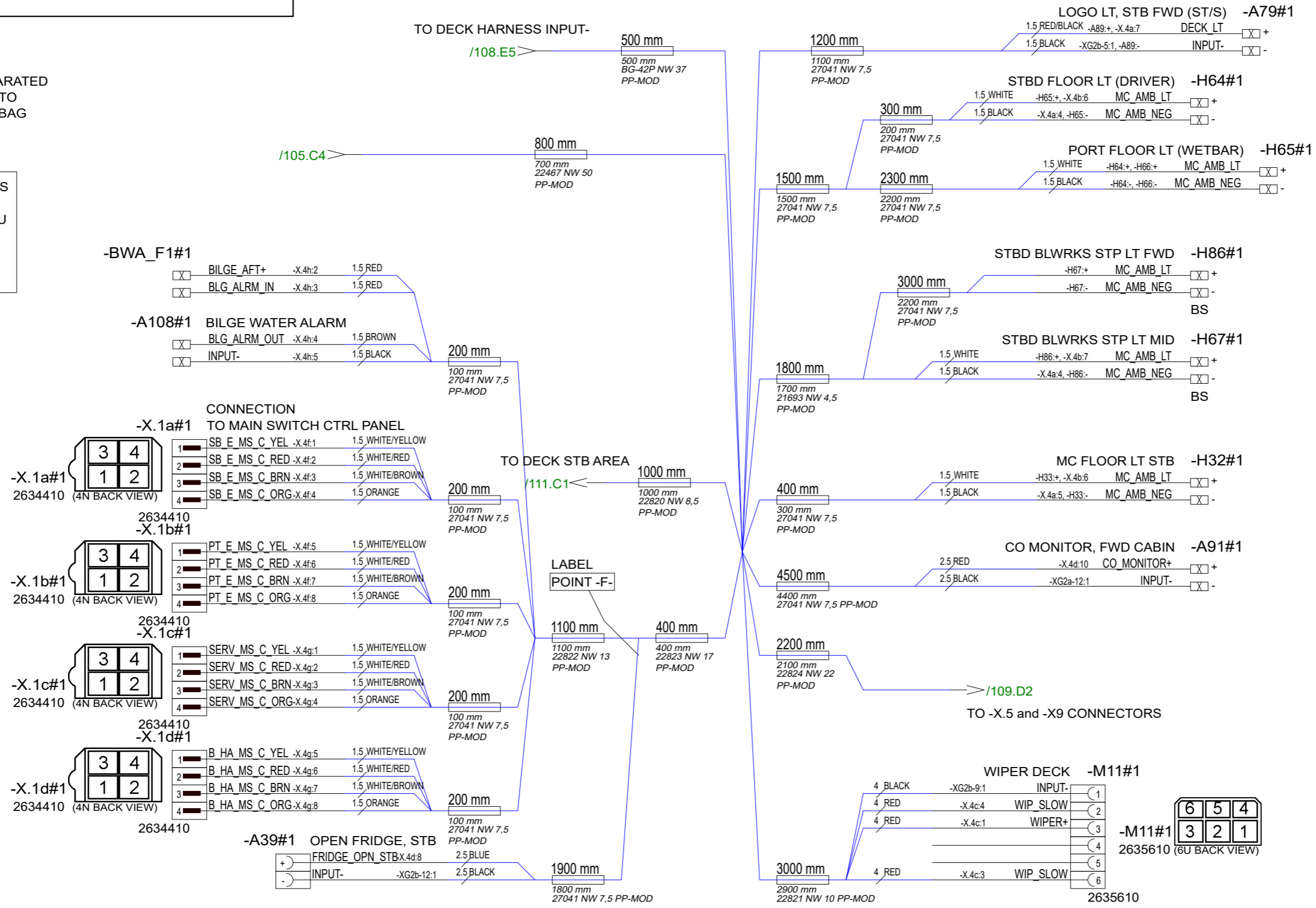
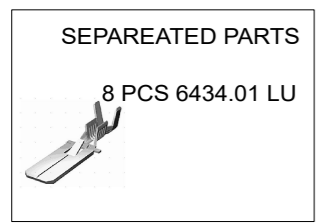
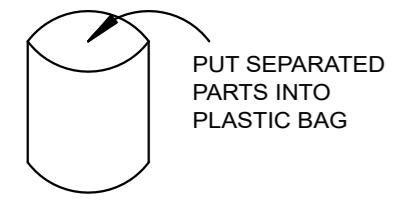
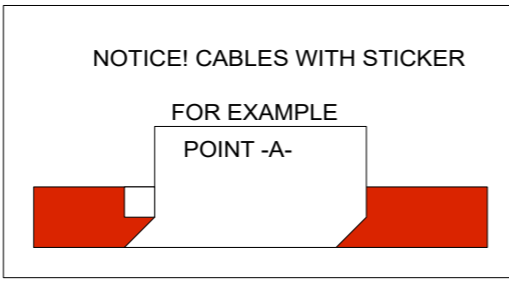
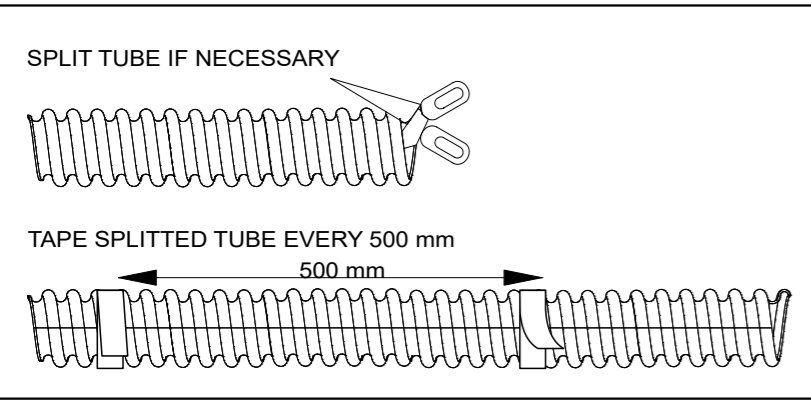

16.10.2023	TT	F10; 2004916; Added outlets A111-A114 & X4j	Date	17.5.2019
11.3.2024	PF	G11: 2005054; Logo It supply to deck lt, flir, light pack	Drawing by	TuM
17.2.2023	RK	F9: SEVERAL MODIFICATIONS	Sheet rev.	11
Date of modification	Modified by	Description	Project rev.	G

NAVIX
designed solutions

Copyright by

Axopar
Boat
37 MY20
Boat model

29586
Product code

Sub-product code
DECK HARNESS
Title

Project ID
HL
Loc

107 / 213
Sheet

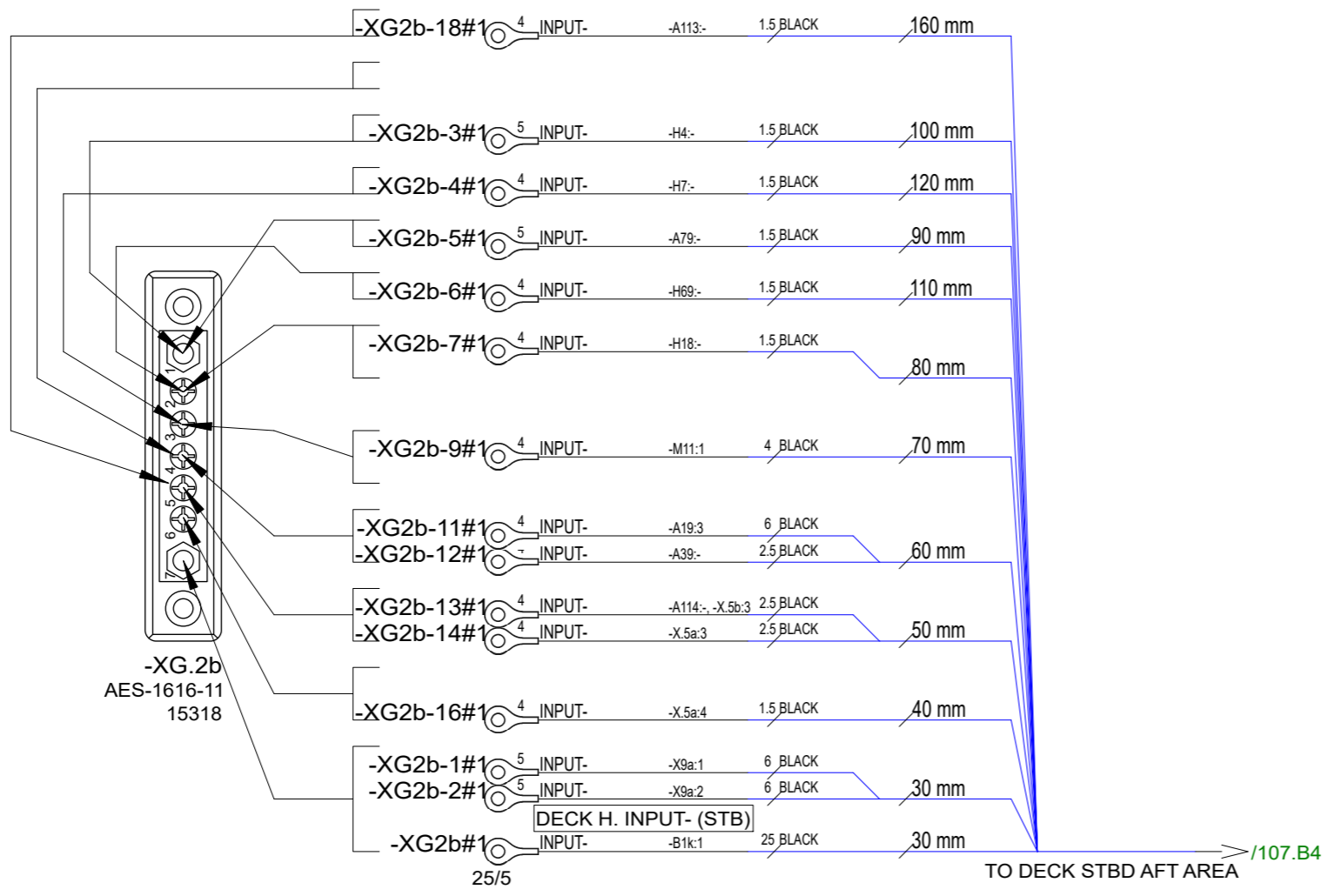
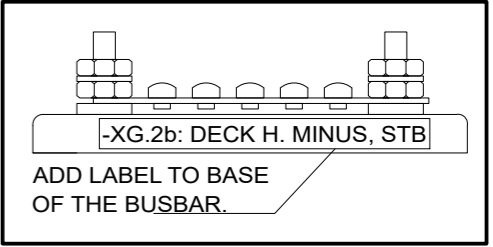
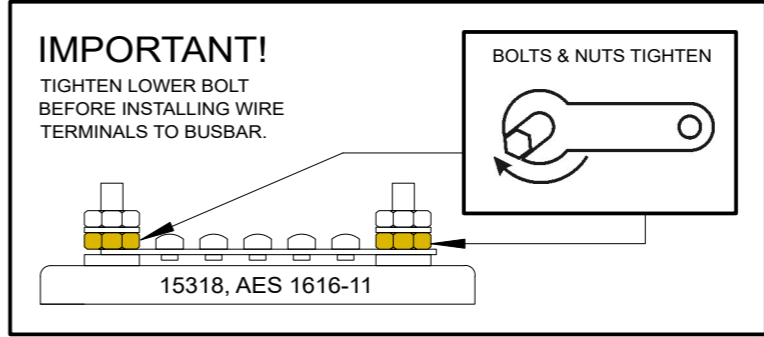

16.10.2023	TT	F10; 2004916; Added outlets A111-A114 & X4j	Date	17.5.2019
11.3.2024	PF	G11: 2005054; Logo It supply to deck lt, flir, light pack	Drawing by	TuM
17.2.2023	RK	F9: SEVERAL MODIFICATIONS	Sheet rev.	11
Date of modification	Modified by	Description	Project rev.	G

NAVIX
designed solutions

Copyright by

Axopar	29586	Project ID
Boat	37 MY20	DECK HARNESS
Boat model	HL	108 / 213
	Loc	Sheet

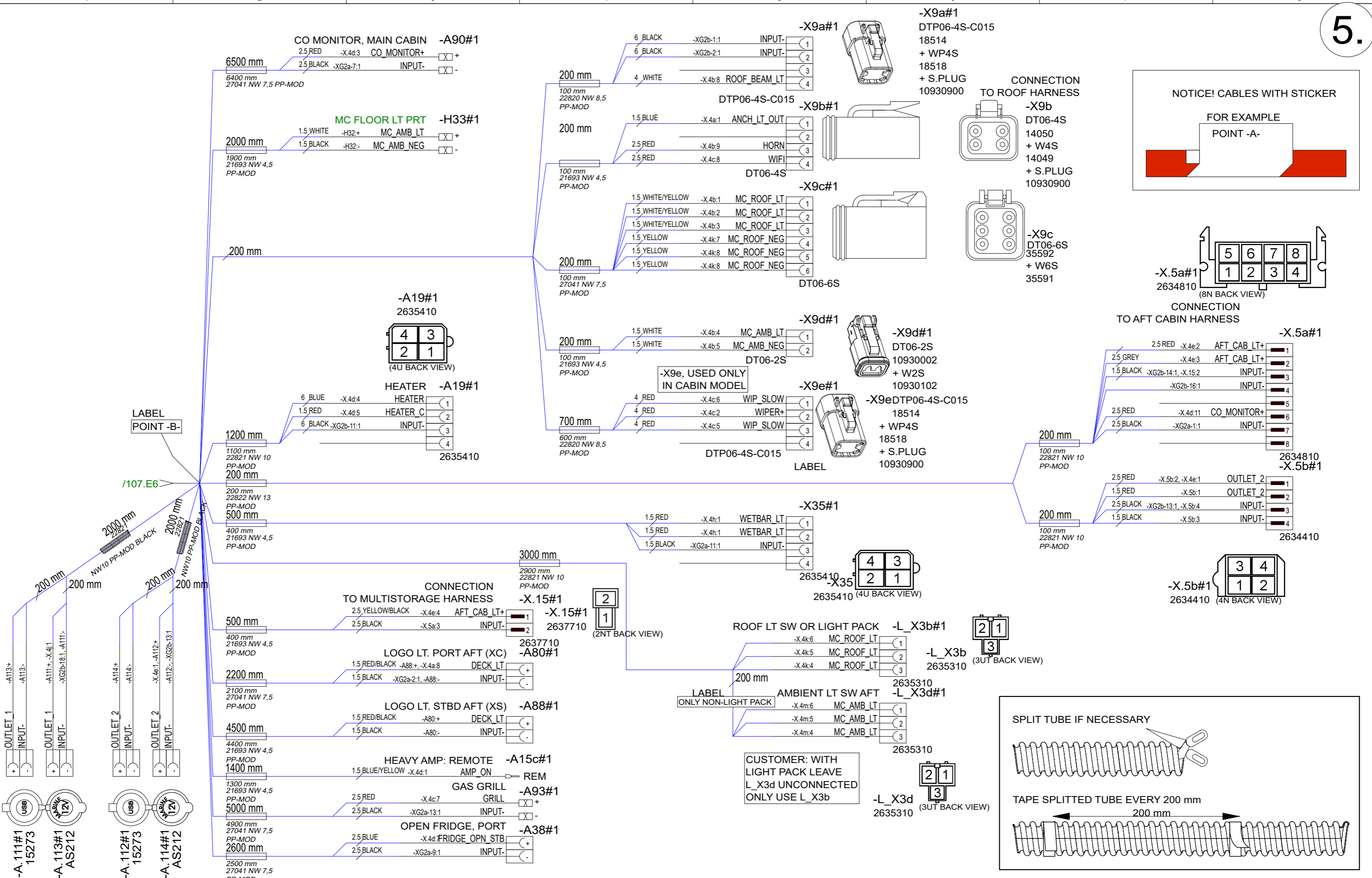

16.10.2023	TT	F10; 2004916; Added outlets A111-A114 & X4j	Date	17.5.2019
11.3.2024	PF	G11: 2005054; Logo lt supply to deck lt, flir, light pack	Drawing by	TuM
17.2.2023	RK	F9: SEVERAL MODIFICATIONS	Sheet rev.	11
Date of modification	Modified by	Description	Project rev.	G

NAVIX designed solutions		Axopar	29586	
Boat		37 MY20	Sub-product code	Product code
Boat model			Project ID	
Title		DECK HARNESS		HL
		Loc		109 / 213
				Sheet

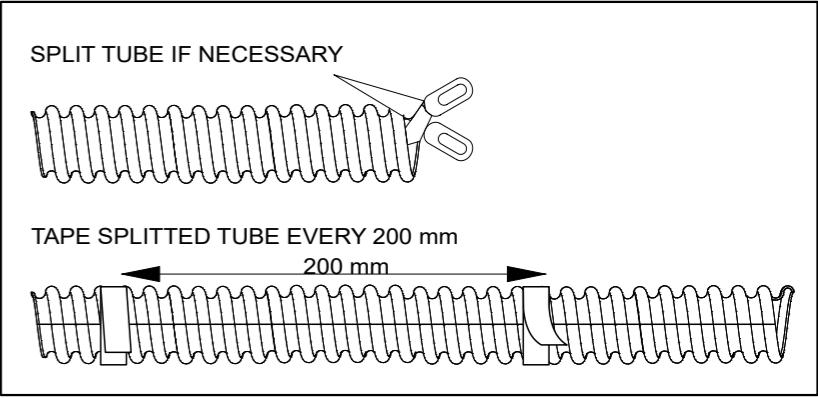
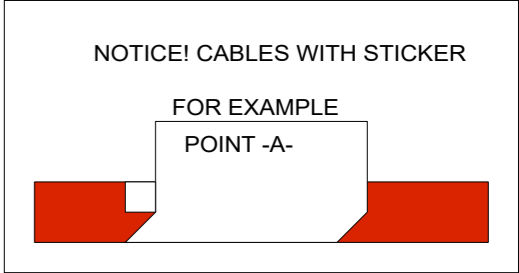
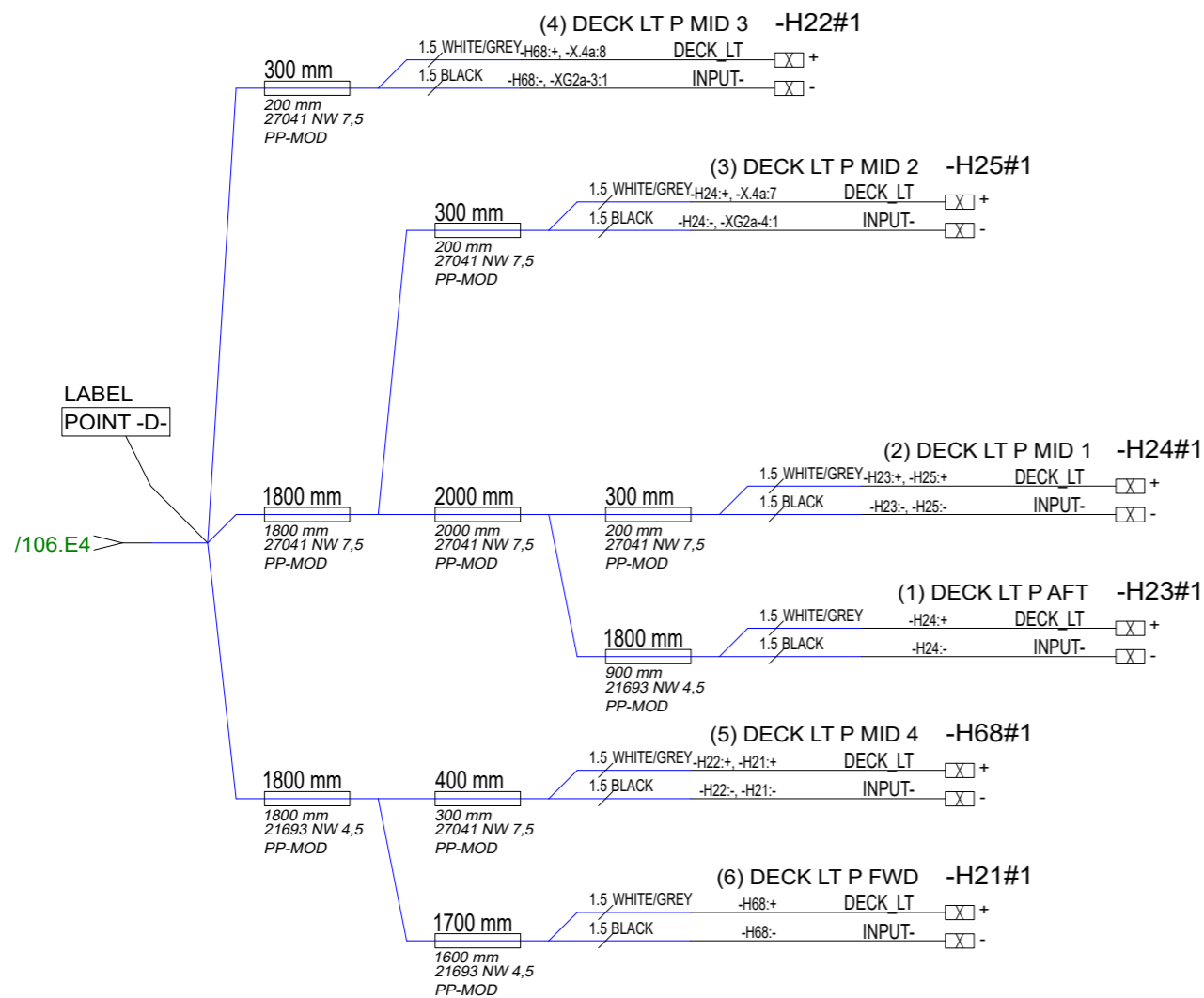

16.10.2023	TT	F10; 2004916; Added outlets A111-A114 & X4j	Date	31.3.2020
11.3.2024	PF	G11: 2005054; Logo It supply to deck lt, flir, light pack	Drawing by	TuM
17.2.2023	RK	F9: SEVERAL MODIFICATIONS	Sheet rev.	11
Date of modification	Modified by	Description	Project rev.	G



Axopar	29586	Project ID	110 / 213
Boat	Sub-product code	Product code	HL
37 MY20	DECK HARNESS	Loc	Sheet
Boat model	Title		

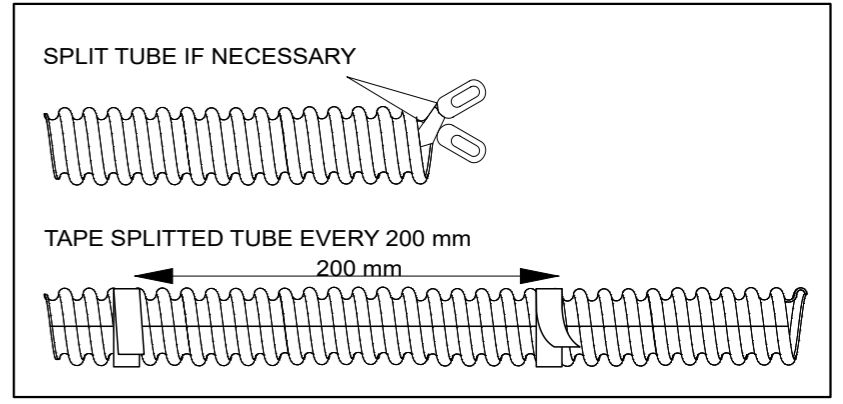
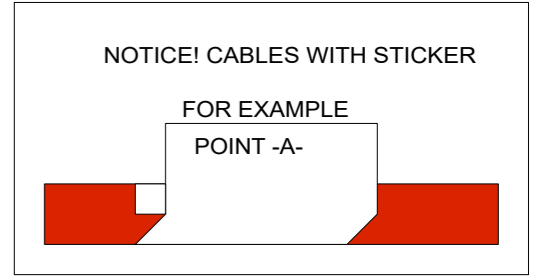
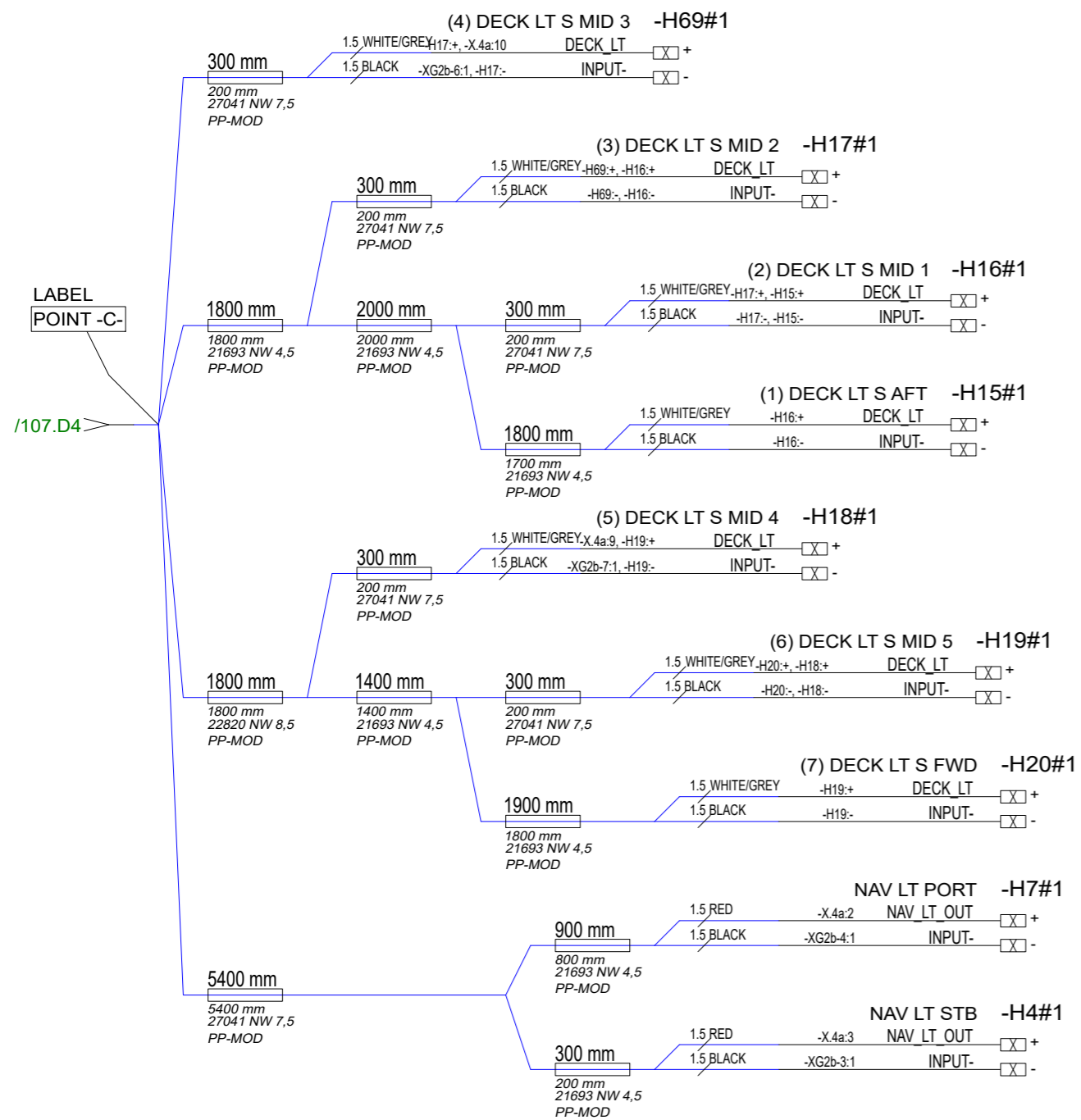

16.10.2023	TT	F10; 2004916; Added outlets A111-A114 & X4j	Date	2.4.2020
11.3.2024	PF	G11: 2005054; Logo It supply to deck lt, flir, light pack	Drawing by	TuM
17.2.2023	RK	F9: SEVERAL MODIFICATIONS	Sheet rev.	11
Date of modification	Modified by	Description	Project rev.	G



Axopar	29586		Project ID
Boat	Sub-product code	Product code	Project ID
37 MY20	DECK HARNESS	HL	111/ 213
Boat model	Title	Loc	Sheet

NOTICE!
 VERIFY THAT ALL CABLES HAVE MARKINGS
 SHOWN IN EXAMPLE BELOW.

EXEMPTION:
 ALL <500mm WIRES AND BLACK WIRES
 THIS MARKING IS NOT NEEDED.

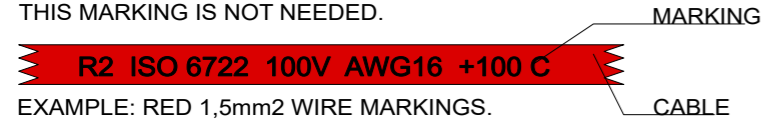

EXAMPLE: RED 1,5mm² WIRE MARKINGS.

CONNECTION
 TO DECK HARNESS

-X5a#1

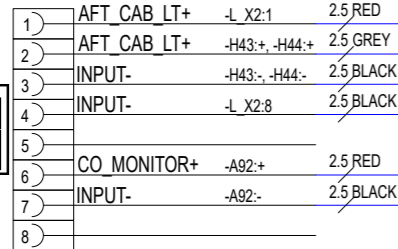

-X5a#1
 2635810
 (8U BACK VIEW)

2635810
 -X5b#1

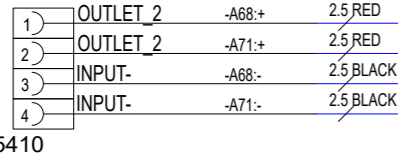

-X5b#1
 2635410
 (4U BACK VIEW)

SPLIT TUBE IF NECESSARY

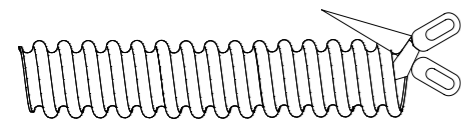

TAPE SPLITTED TUBE EVERY 200 mm

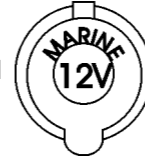
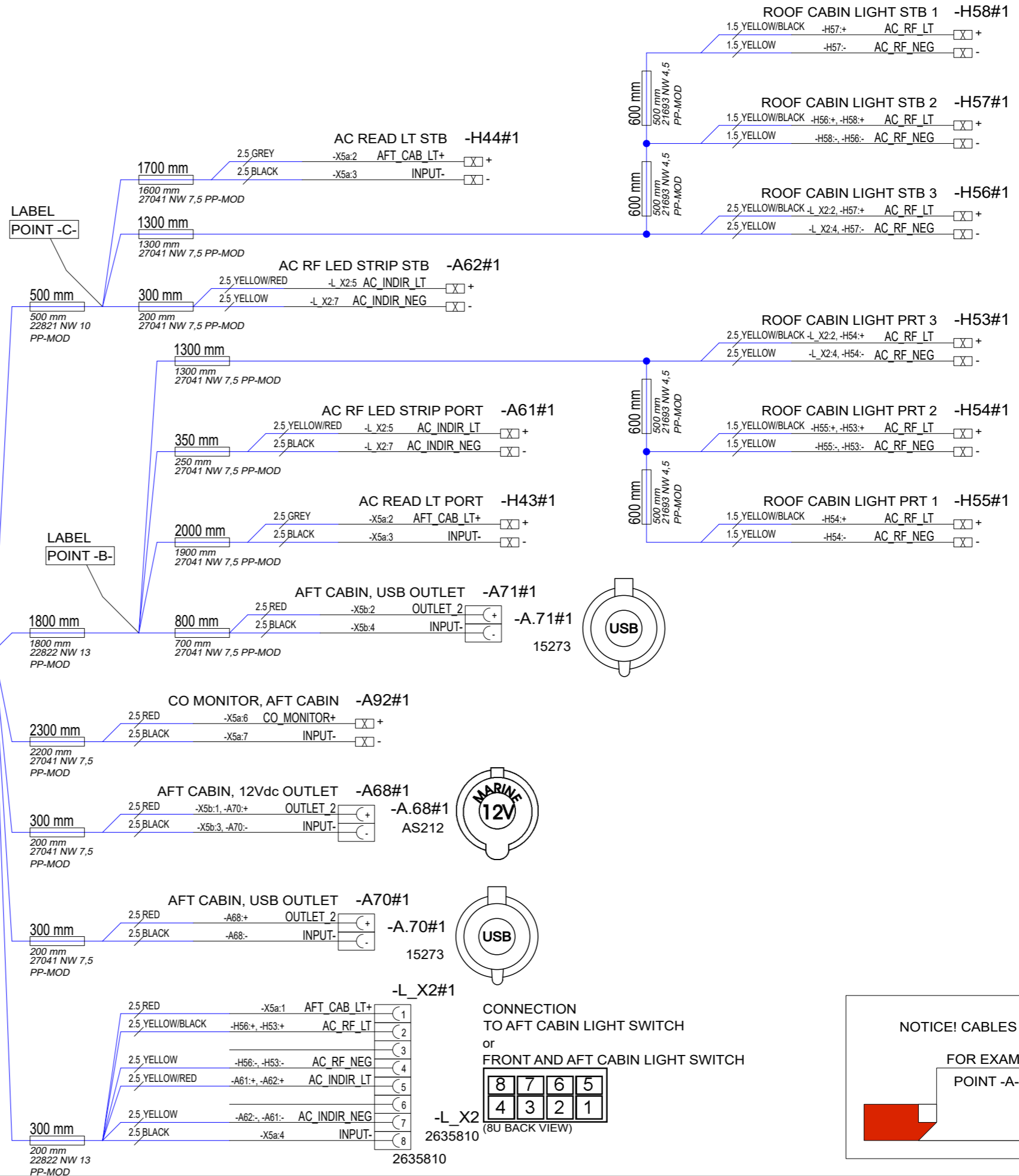
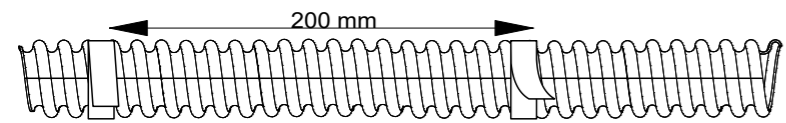

CONNECTION
 TO AFT CABIN LIGHT SWITCH
 or
 FRONT AND AFT CABIN LIGHT SWITCH

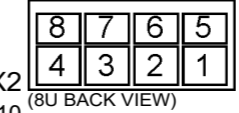

-L_X2
 2635810
 (8U BACK VIEW)

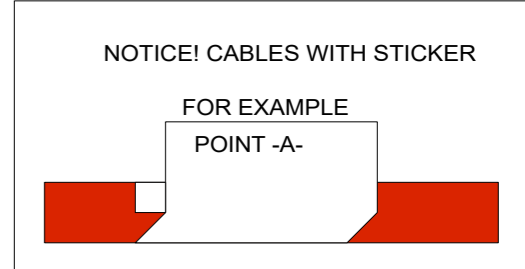

22.9.2021	VV	E5: NOT MODIFIED / REVISION RETURNED TO REV. E.	Date	16.5.2019	NAVIX designed solutions	Axopar	29588	Project ID
17.2.2023	RK	F5: NOT MODIFIED.	Drawing by	TuM		Boat		
4.4.2024	PF	G6: 2005054; Light pack changes	Sheet rev.	6	Copyright by	Boat model	AFT CABIN HARNESS	HL
Date of modification	Modified by	Description	Project rev.	G		Title	Loc	113 / 213 Sheet

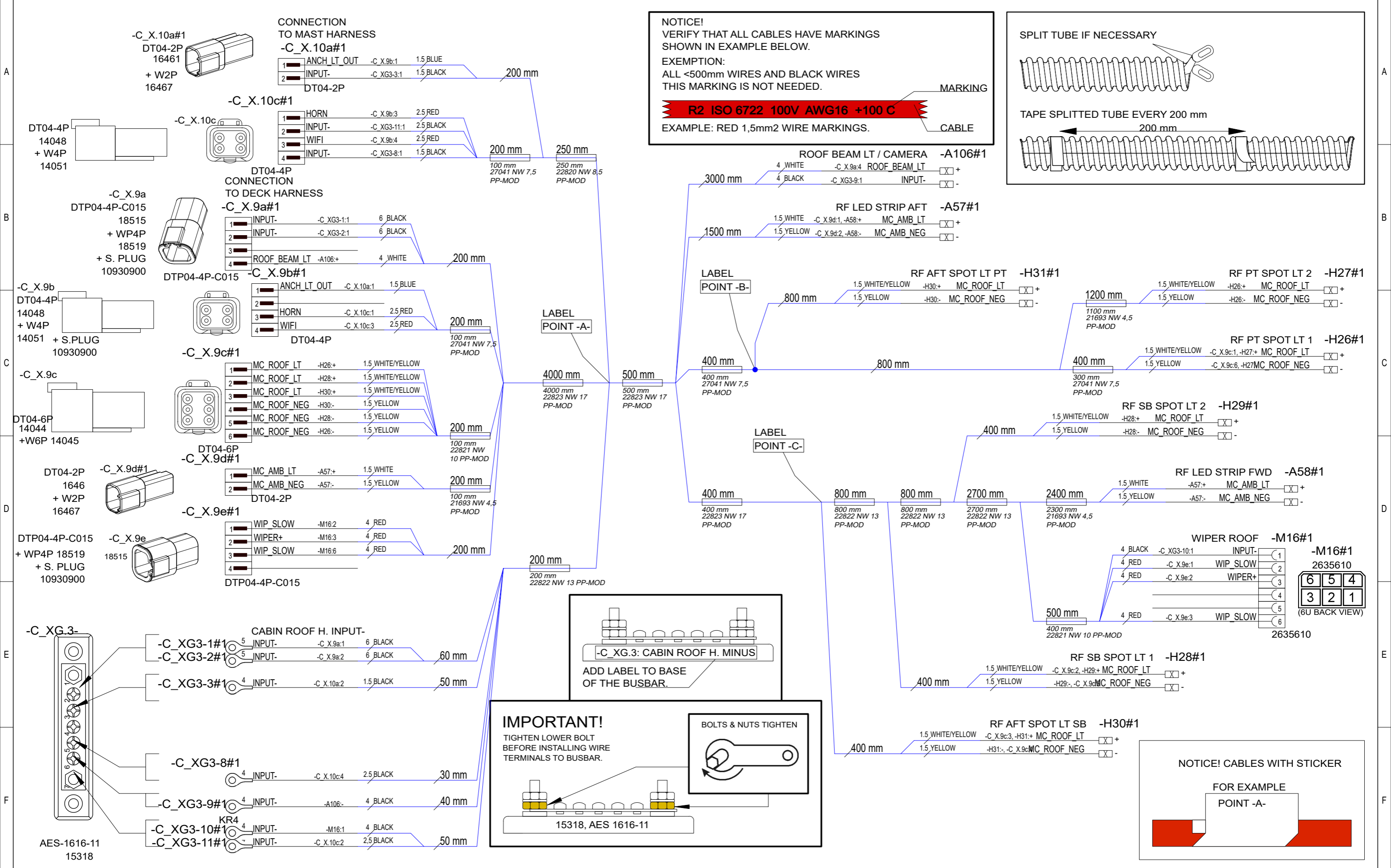

11.3.2024	PF	G8: 2005054; Light return paths, wifi minus, A106 description, C_X.9	Date	17.5.2019	 Axopar Boat 37 MY20 Boat model	Sub-product code CABIN ROOF HARNESS Title	29589 Product code HL Loc	Project ID 114 / 213 Sheet
22.9.2021	VV	E7: NOT MODIFIED / REVISION RETURNED TO REV. E.	Drawing by	TuM				
17.2.2023	RK	F7: NOT MODIFIED.	Sheet rev.	8				
Date of modification	Modified by	Description	Project rev.	G	Copyright by			

NOTICE!
 VERIFY THAT ALL CABLES HAVE MARKINGS
 SHOWN IN EXAMPLE BELOW.
 EXEMPTION:
 ALL <500mm WIRES AND BLACK WIRES
 THIS MARKING IS NOT NEEDED.

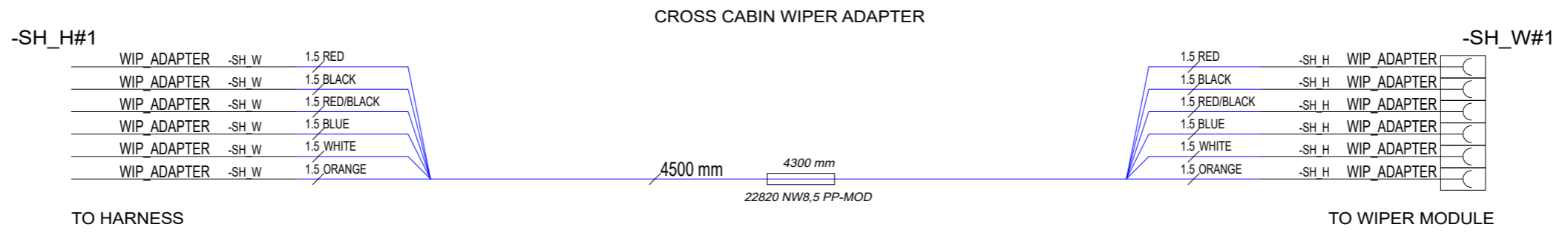
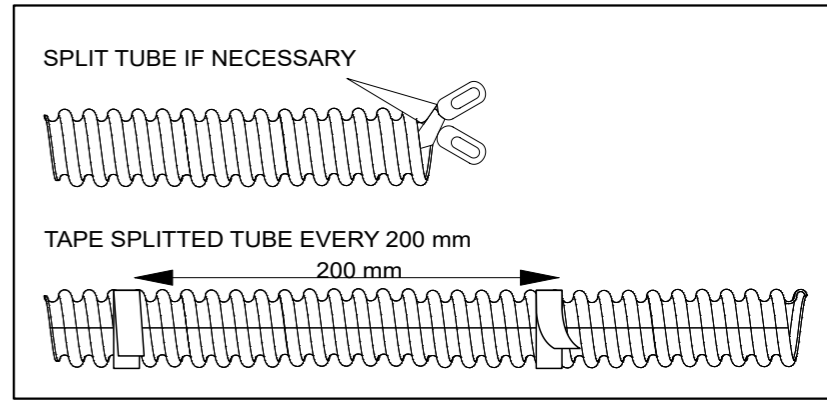

11.3.2024	PF	G8: 2005054; Light return paths, wifi minus, A106 description
22.9.2021	VV	E7: NOT MODIFIED / REVISION RETURNED TO REV. E.
17.2.2023	RK	F7: NOT MODIFIED.
Date of modification	Modified by	Description

Date	17.5.2019
Drawing by	TuM
Sheet rev.	8
Project rev.	G



Axopar	29589	Project ID
Boat	37 MY20	CABIN ROOF HARNESS
Boat model		HL
		Loc
		115 / 213
		Sheet

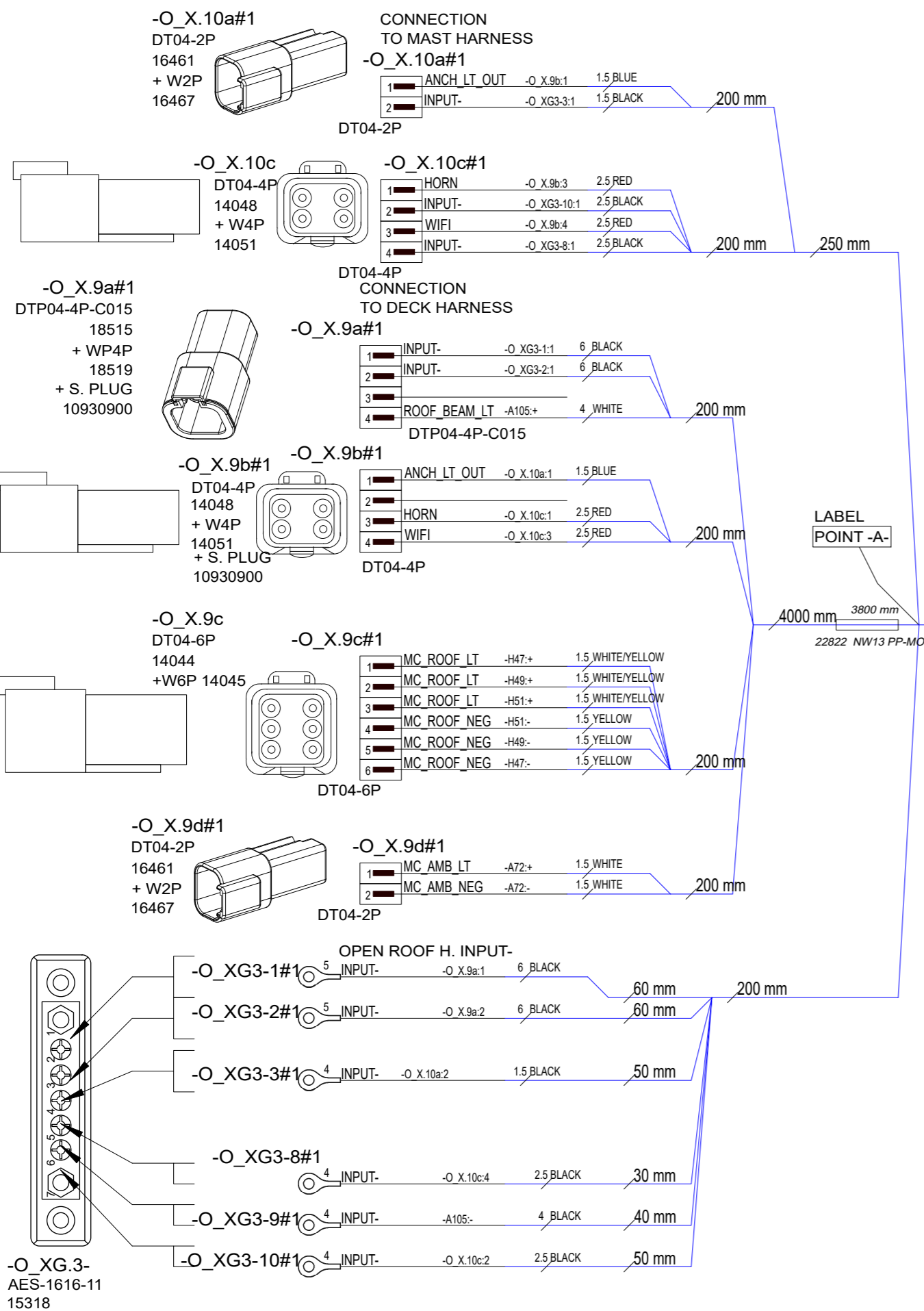

NOTICE!
 VERIFY THAT ALL CABLES HAVE MARKINGS SHOWN IN EXAMPLE BELOW.
 EXEMPTION:
 ALL <500mm WIRES AND BLACK WIRES THIS MARKING IS NOT NEEDED.

R2 ISO 6722 100V AWG16 +100 C

EXAMPLE: RED 1,5mm² WIRE MARKINGS.

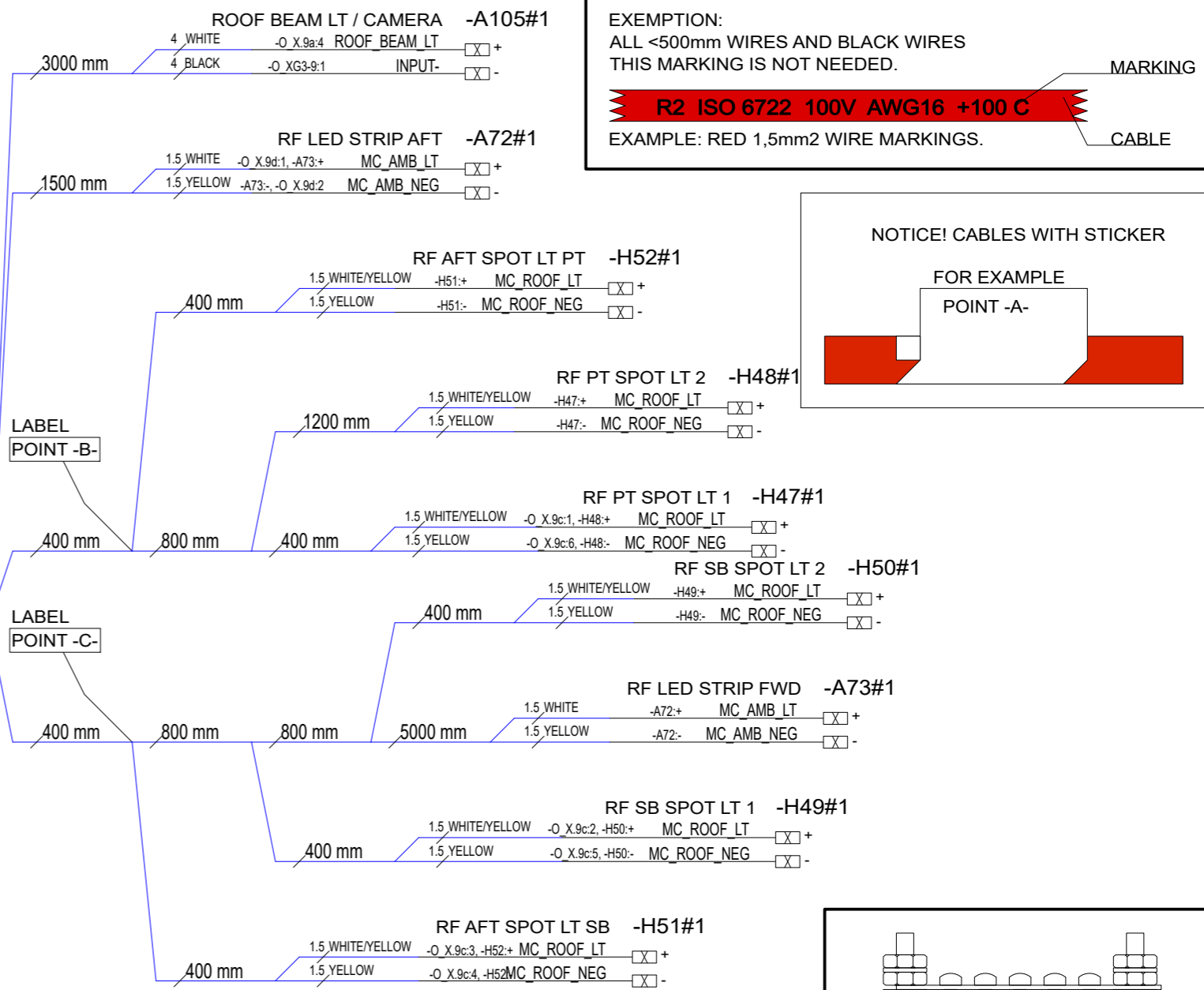
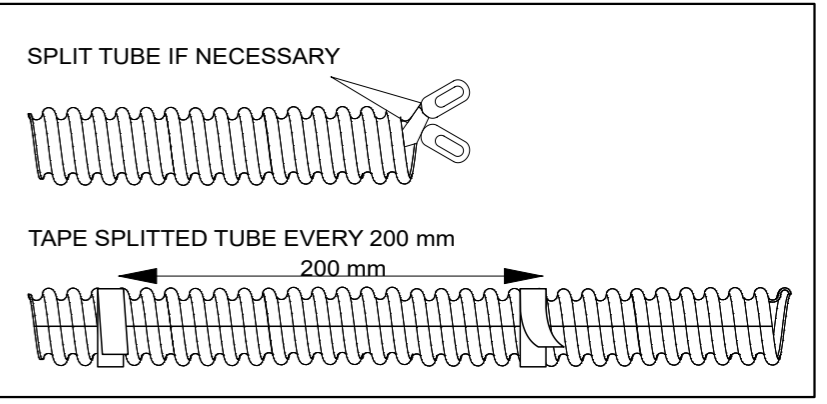
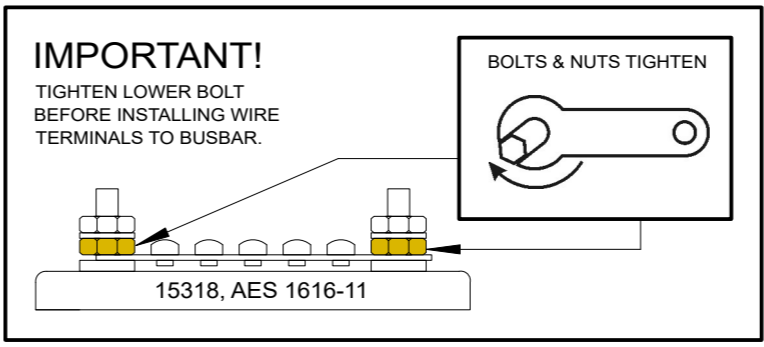
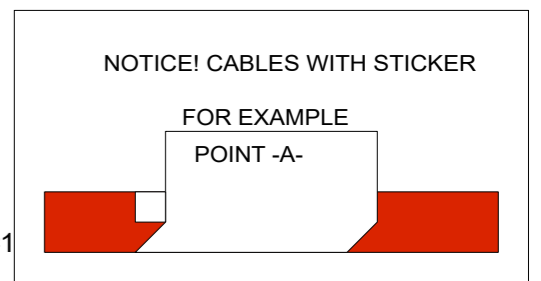

11.3.2024	PF	G8: 2005054; Light return paths, wifi minus, A105 description	Date	17.5.2019
22.9.2021	VV	E7: NOT MODIFIED / REVISION RETURNED TO REV. E.	Drawing by	TuM
17.2.2023	RK	F7: NOT MODIFIED.	Sheet rev.	8
Date of modification	Modified by	Description	Project rev.	G

<p>NAVIX designed solutions</p>		Axopar		29590		Project ID	
		Boat	37 MY20	Sub-product code	OPEN ROOF HARNESS	Product code	HL
Copyright by		Boat model		Title	Loc		

NOTICE!
 VERIFY THAT ALL CABLES HAVE MARKINGS
 SHOWN IN EXAMPLE BELOW.
 EXEMPTION:
 ALL <500mm WIRES AND BLACK WIRES
 THIS MARKING IS NOT NEEDED.

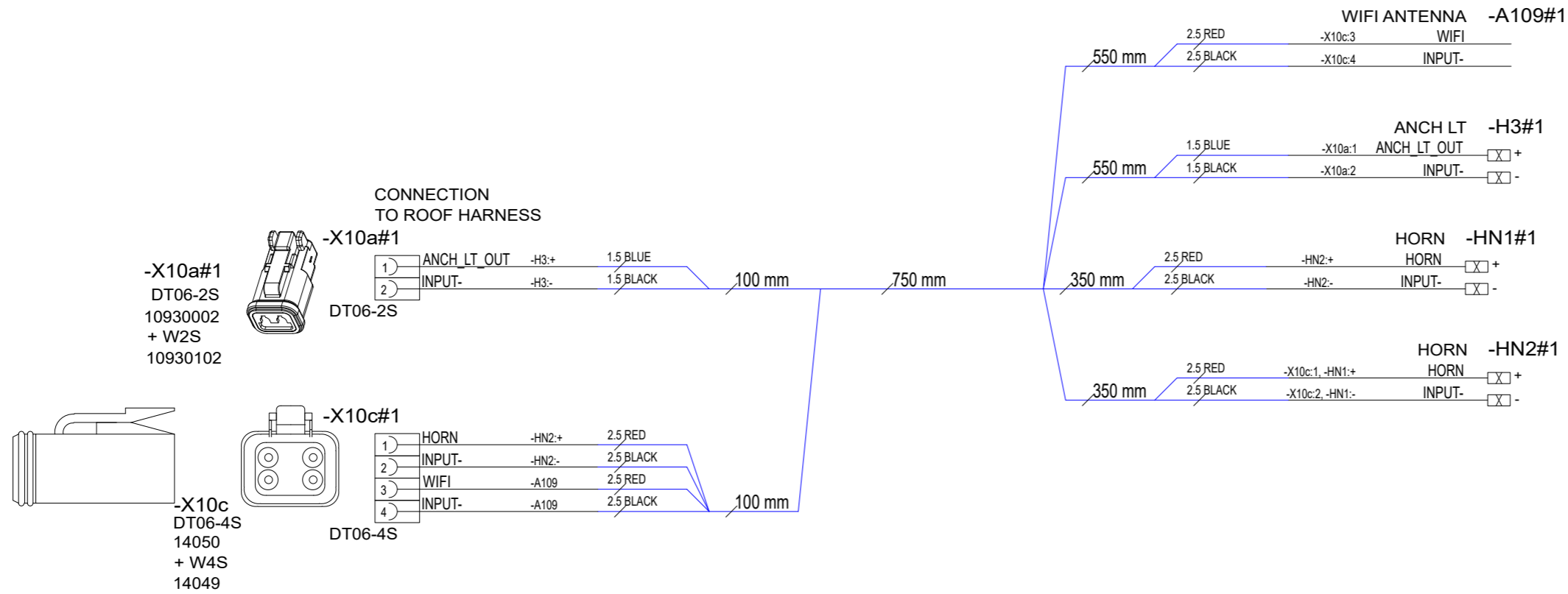
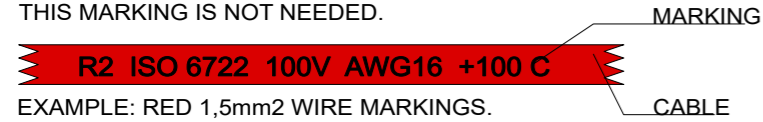

22.9.2021	VV	E5: NOT MODIFIED / REVISION RETURNED TO REV. E.
17.2.2023	RK	F5: NOT MODIFIED.
15.06.2021	TT	G6: 2005054; Wifi minus 1,5mm ² ->2,5mm ²
Date of modification	Modified by	Description

Date	16.5.2019
Drawing by	TuM
Sheet rev.	6
Project rev.	G



Axopar	29591	Project ID
Boat	37 MY20	Sub-product code
Boat model	MAST HARNESS	Product code
	HL	Loc
		117 / 213 Sheet

NOTICE!
 VERIFY THAT ALL CABLES HAVE MARKINGS
 SHOWN IN EXAMPLE BELOW.
 EXEMPTION:
 ALL <500mm WIRES AND BLACK WIRES
 THIS MARKING IS NOT NEEDED.



NOTICE! CABLES WITH STICKER

FOR EXAMPLE
 POINT -A-

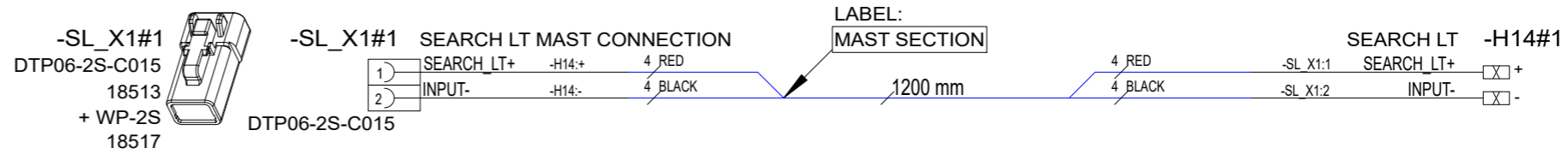
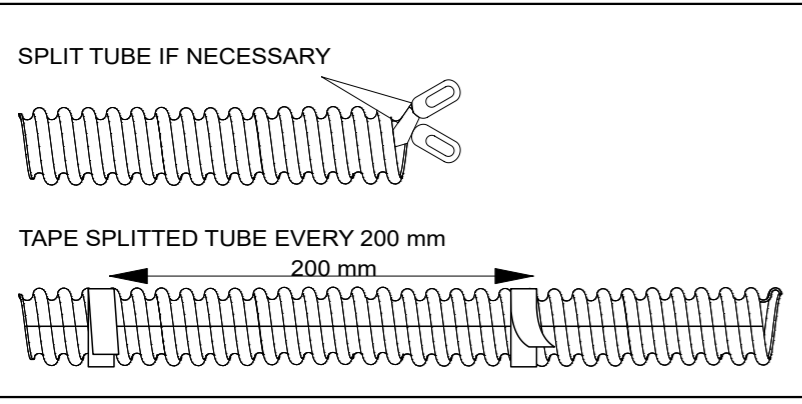
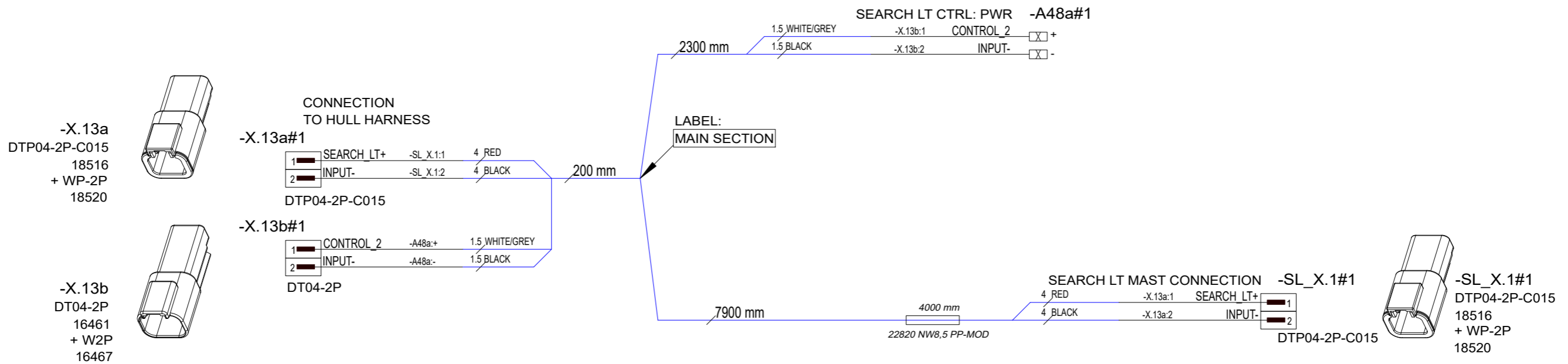

15.4.2024	PF	G5: 2005054; Not modified	Date	21.5.2019		Axopar				
22.9.2021	VV	E5: NOT MODIFIED / REVISION RETURNED TO REV. E.	Drawing by	TuM		Boat	Sub-product code	29592	Product code	Project ID
17.2.2023	RK	F5: NOT MODIFIED.	Sheet rev.	5		37 MY20	SEARCH LT HARNESS		HL	118 / 213
Date of modification	Modified by	Description	Project rev.	G		Boat model	Title	Loc	Sheet	

NOTICE!
 VERIFY THAT ALL CABLES HAVE MARKINGS
 SHOWN IN EXAMPLE BELOW.
 EXEMPTION:
 ALL <500mm WIRES AND BLACK WIRES
 THIS MARKING IS NOT NEEDED.

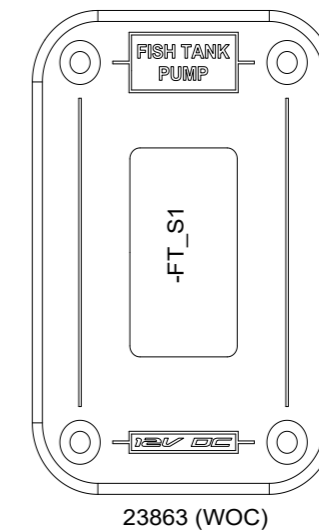
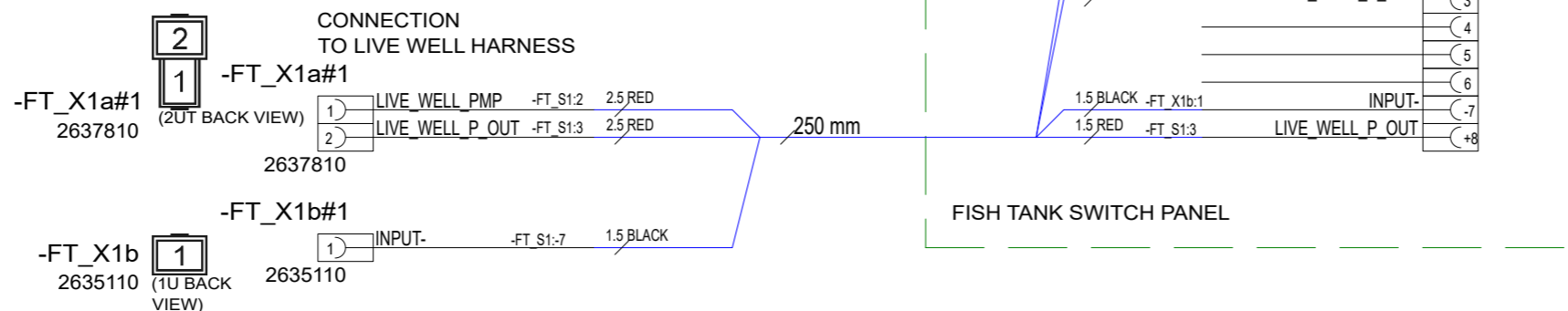
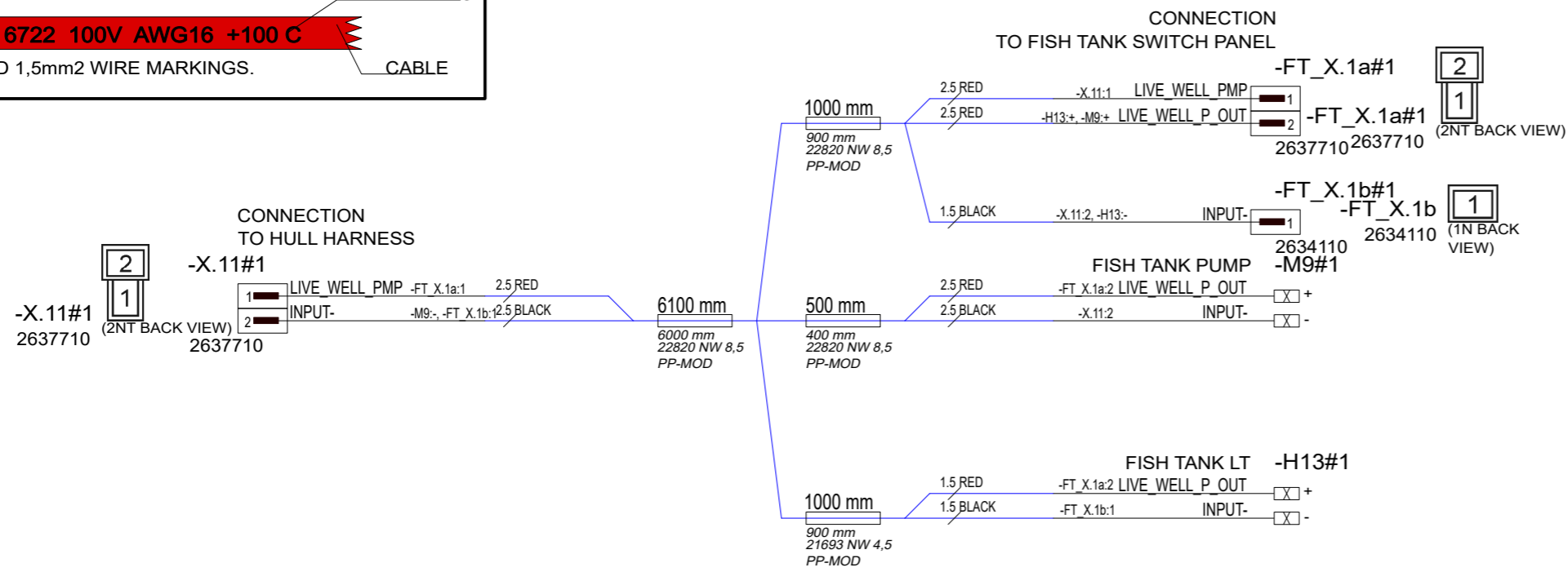
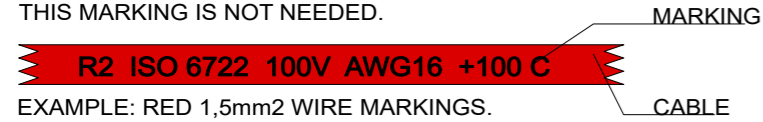

15.4.2024	PF	G4: 2005054; Not modified	Date	21.5.2019		Axopar	23863	29593	Project ID
17.2.2023	RK	F3: NOT MODIFIED.	Drawing by	TuM		Boat	Sub-product code	Product code	
28.11.2023	PF	F4: 2004954/2004916; Switch changed to locking type, wiring modified	Sheet rev.	4		37 MY20	LIVE WELL HARNESS		HL
Date of modification	Modified by	Description	Project rev.	G		Boat model	Title	Loc	119 / 213 Sheet

NOTICE!
 VERIFY THAT ALL CABLES HAVE MARKINGS
 SHOWN IN EXAMPLE BELOW.
 EXEMPTION:
 ALL <500mm WIRES AND BLACK WIRES
 THIS MARKING IS NOT NEEDED.



SPLIT TUBE IF NECESSARY

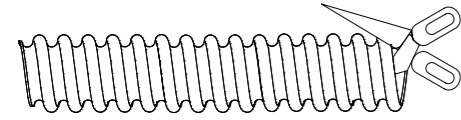

TAPE SPLITTED TUBE EVERY 200 mm

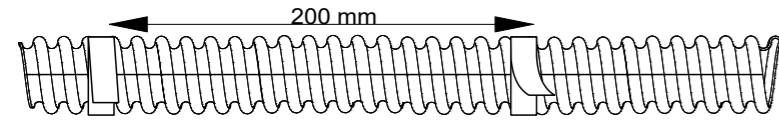

-X.12#1
 DTP04-2P-C015
 18516
 + WP-2P
 18520

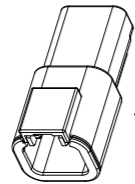

DTP04-2P-C015

CONNECTION
 TO HULL HARNESS

-X.12#1

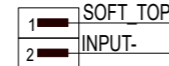

1 SOFT_TOP -A49a:+ 6 RED
 2 INPUT- -A49a:- 6 BLACK

6600 mm

4000 mm

22821 NW10 PP-MOD

SOFT TOP: POWER -A49a#1

6 RED -X.12:1 SOFT_TOP +
 6 BLACK -X.12:2 INPUT- -

-A50#1 SOFT TOP CTRL SWITCH

BN SOFT_TOP_OP -A49b:BN 1.5 BROWN
 BL SOFT_TOP_C- -A49b:BL 1.5 BLACK
 RD SOFT_TOP_CL -A49b:RD 1.5 RED

6500 mm

SOFT TOP: CONTROLS -A49b#1

1.5 BROWN -A50:BN SOFT_TOP_OP BN
 1.5 BLACK -A50:BL SOFT_TOP_C- BL
 1.5 RED -A50:RD SOFT_TOP_CL RD

15.4.2024	PF	G5: 2005054; Not modified
22.9.2021	VV	E5: NOT MODIFIED / REVISION RETURNED TO REV. E.
17.2.2023	RK	F5: NOT MODIFIED.
Date of modification	Modified by	Description

Date	21.5.2019
Drawing by	TuM
Sheet rev.	5
Project rev.	G



Axopar	29594	Project ID
Boat	37 MY20	Product code
Boat model	ELECTRICAL ROOF HARNESS	Loc
		120 / 213 Sheet

1.

-F_X.1
MAIN SUPPLY CONNECTION
COPPER BAR

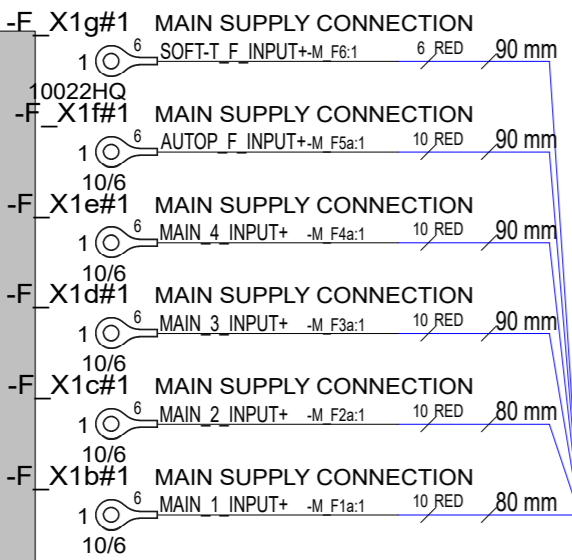

-F_X.2
DIRECT SUPPLY CONNECTION
COPPER BAR

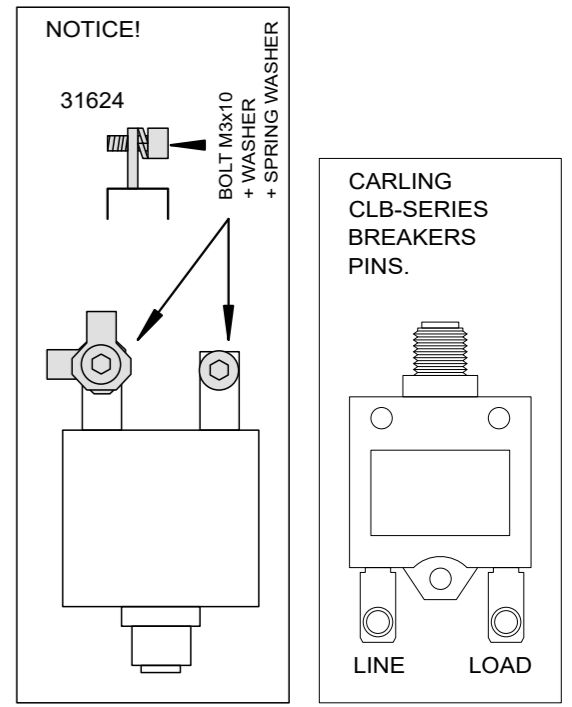
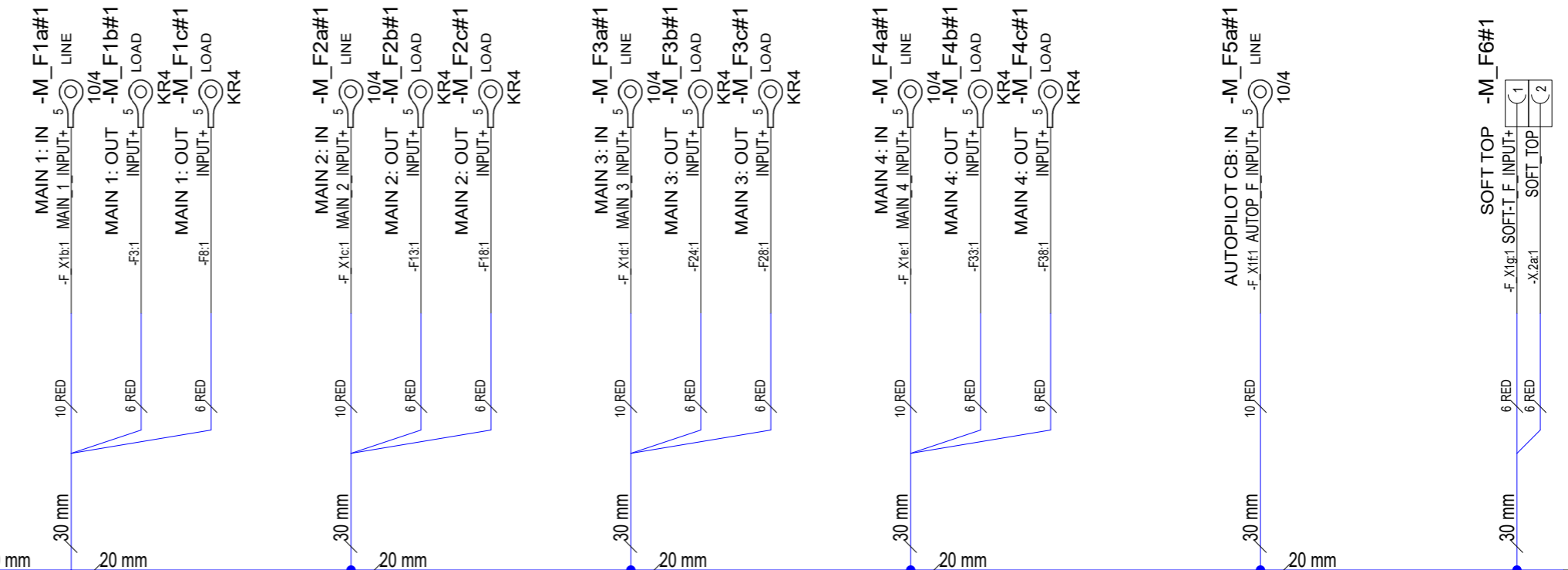
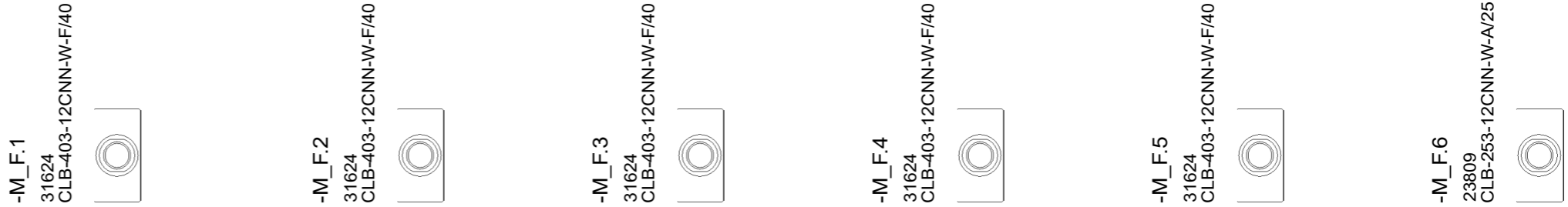
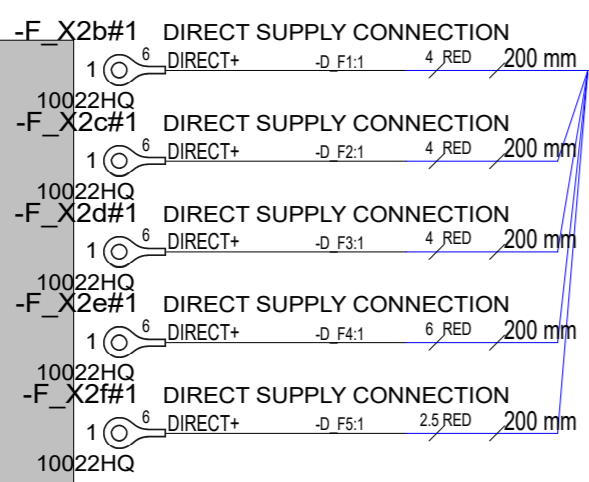

17.2.2023	RK	F9: -F18 NOW USED FOR WETBAR LT	Date	11.6.2019
23.11.2023	PF	F10: 2004954; Changed livewell fuse to 3A	Drawing by	TuM
13.4.2024	PF	G11: 2005054; F47 10A->16A	Sheet rev.	11
Date of modification	Modified by	Description	Project rev.	G



Axopar
Boat
37 MY20
Boat model

SEE EXP. VIEW	29595	Project ID
Sub-product code	Product code	
FUSE UNIT	HL	121/ 213
Title	Loc	Sheet

2.



17.2.2023	RK	F9: -F18 NOW USED FOR WETBAR LT	Date	11.6.2019		Axopar	SEE EXP. VIEW	29595	Project ID
23.11.2023	PF	F10: 2004954; Changed livewell fuse to 3A	Drawing by	TuM		Boat	Sub-product code	Product code	
13.4.2024	PF	G11: 2005054; F47 10A->16A	Sheet rev.	11	37 MY20	FUSE UNIT	HL	122 / 213	
Date of modification	Modified by	Description	Project rev.	G	Boat model	Title	Loc		Sheet

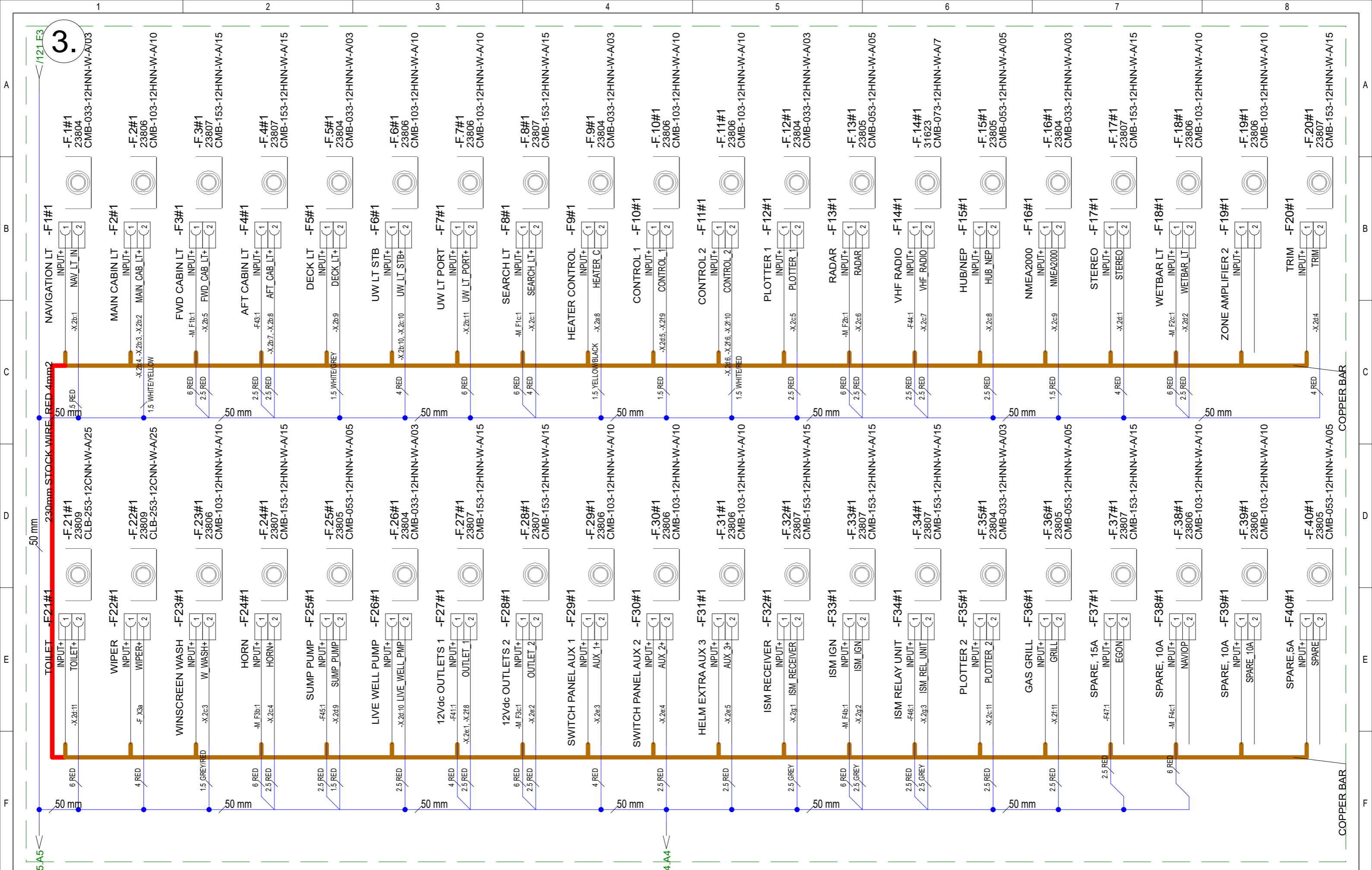

17.2.2023	RK	F9: -F18 NOW USED FOR WETBAR LT	Date	11.6.2019
23.11.2023	PF	F10: 2004954; Changed livewell fuse to 3A	Drawing by	TuM
13.4.2024	PF	G11: 2005054; F47 10A->16A	Sheet rev.	11
Date of modification	Modified by	Description	Project rev.	G



Copyright by

Axopar

Boat

37 MY20

Boat model

SEE EXP. VIEW

Sub-product code

FUSE UNIT

Title

29595

Product code

HL

Loc

Project ID

123 / 213

Sheet

4.

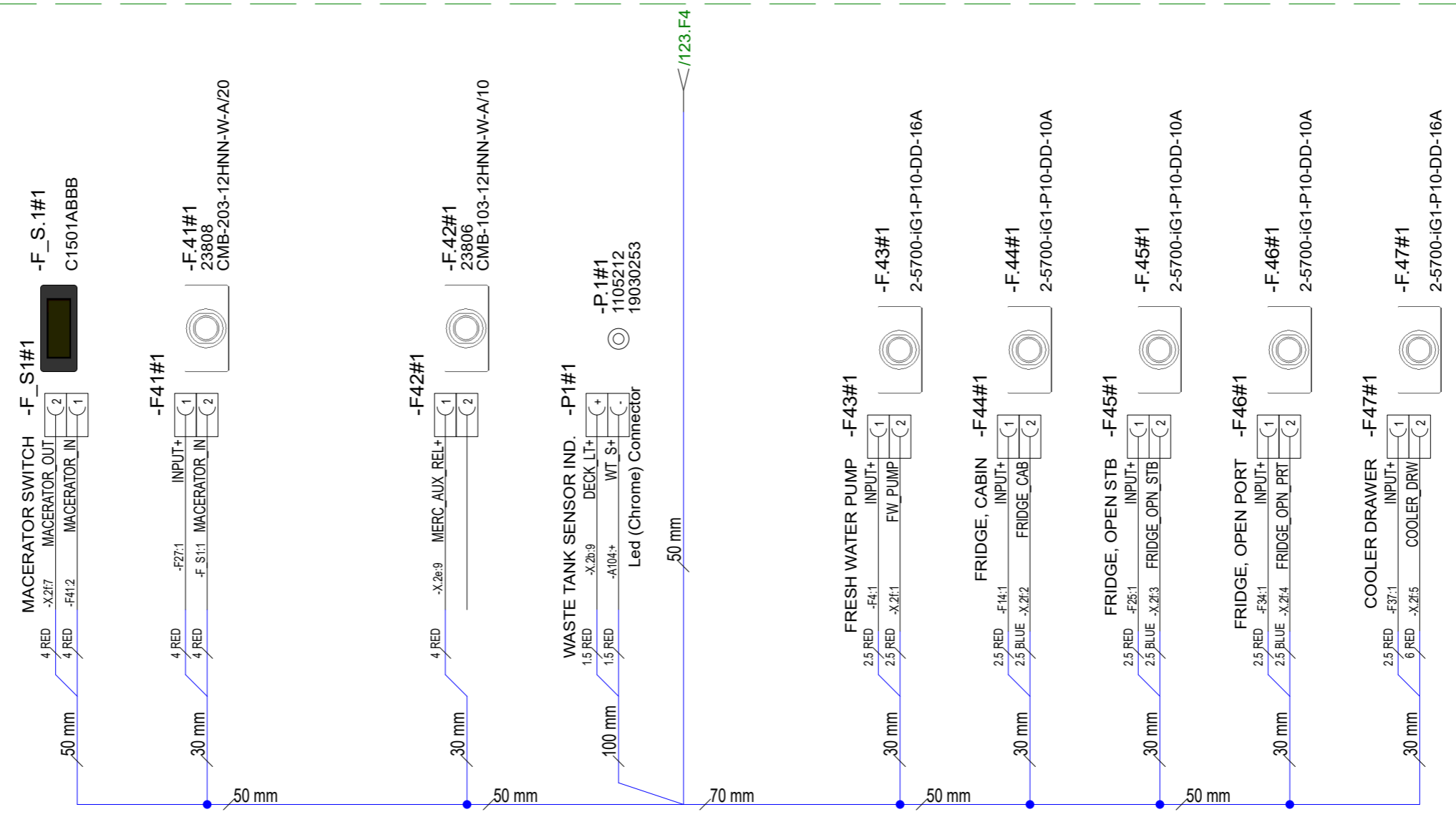

17.2.2023	RK	F9: -F18 NOW USED FOR WETBAR LT	Date	11.6.2019		Axopar	SEE EXP. VIEW	29595	Project ID HL Loc 124 / 213 Sheet
23.11.2023	PF	F10: 2004954; Changed livewell fuse to 3A	Drawing by	TuM		Boat	Sub-product code	Product code	
13.4.2024	PF	G11: 2005054; F47 10A->16A	Sheet rev.	11		37 MY20	FRUSE UNIT		
Date of modification	Modified by	Description	Project rev.	G		Boat model	Title		

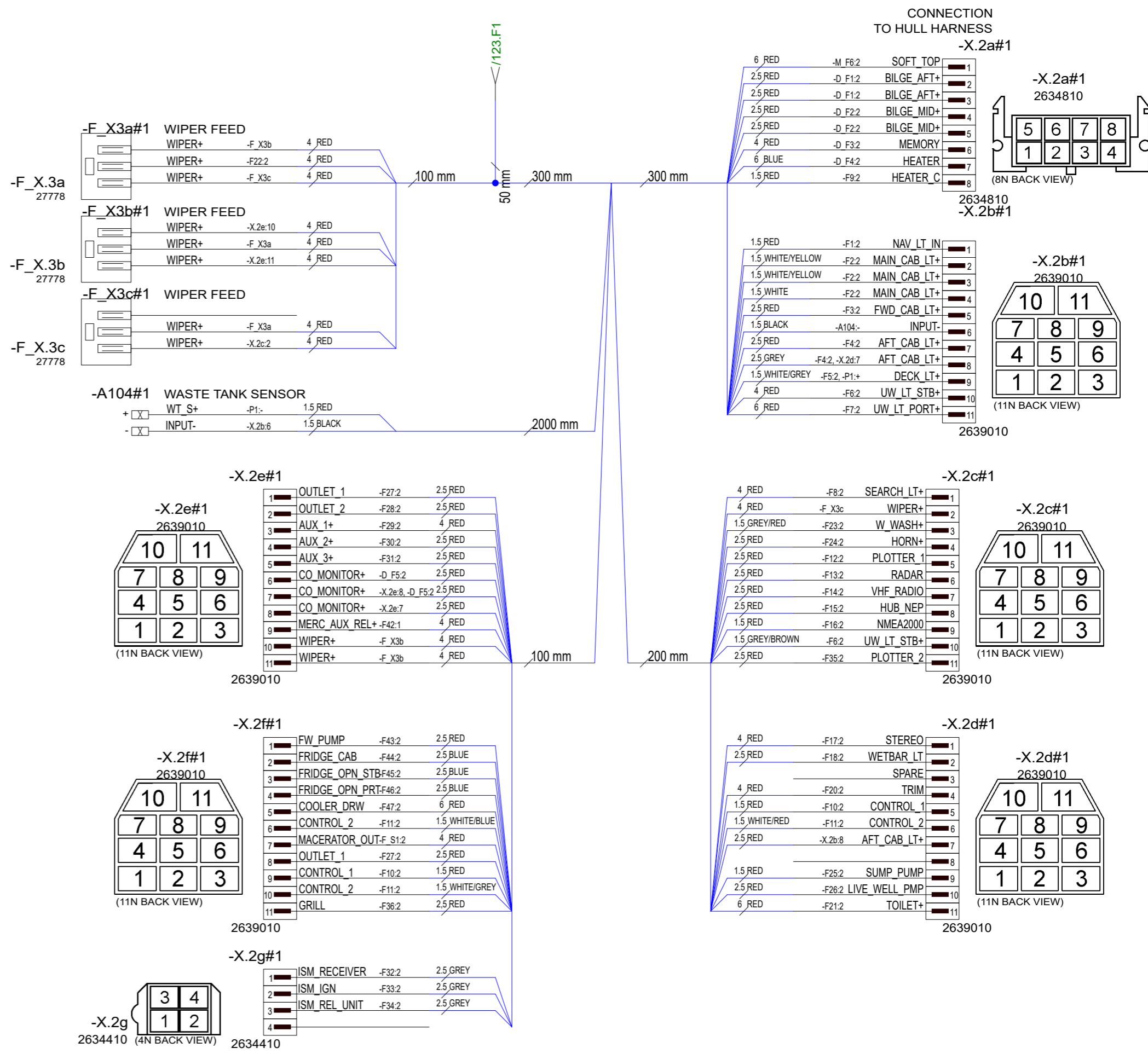

NOTICE!
 VERIFY THAT ALL CABLES HAVE MARKINGS SHOWN IN EXAMPLE BELOW.
 EXEMPTION:
 ALL <500mm WIRES AND BLACK WIRES THIS MARKING IS NOT NEEDED.

EXAMPLE: RED 1,5mm² WIRE MARKINGS.

17.2.2023	RK	F9: -F18 NOW USED FOR WETBAR LT	Date	11.6.2019		Axopar	SEE EXP. VIEW	29595	Project ID
23.11.2023	PF	F10: 2004954; Changed livewell fuse to 3A	Drawing by	TuM		Boat			
13.4.2024	PF	G11: 2005054; F47 10A->16A	Sheet rev.	11		37 MY20	FUSE UNIT	HL	125 / 213
Date of modification	Modified by	Description	Project rev.	G		Boat model		Title	

FUSE PANEL GENERAL LAYOUT/ LABELS

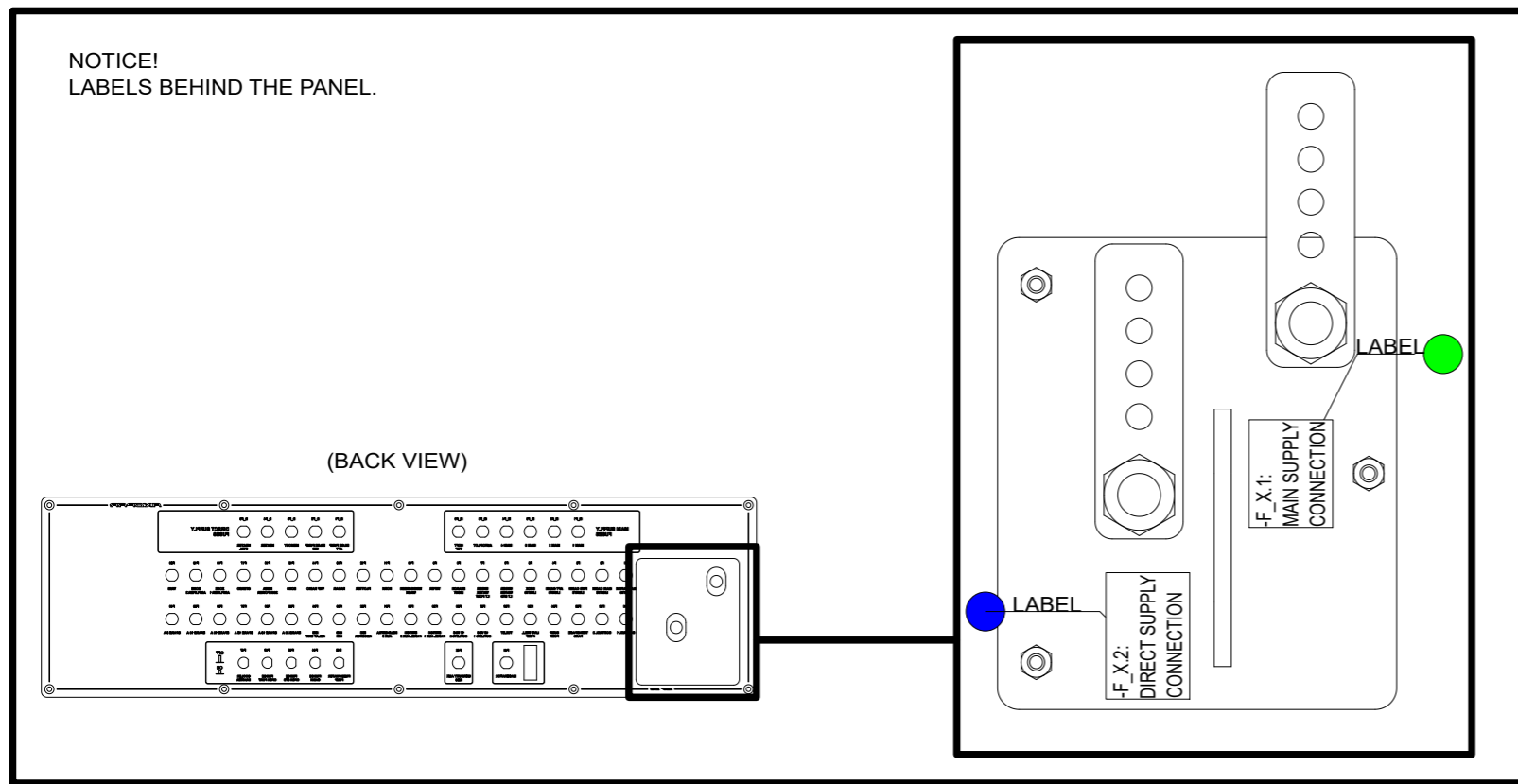
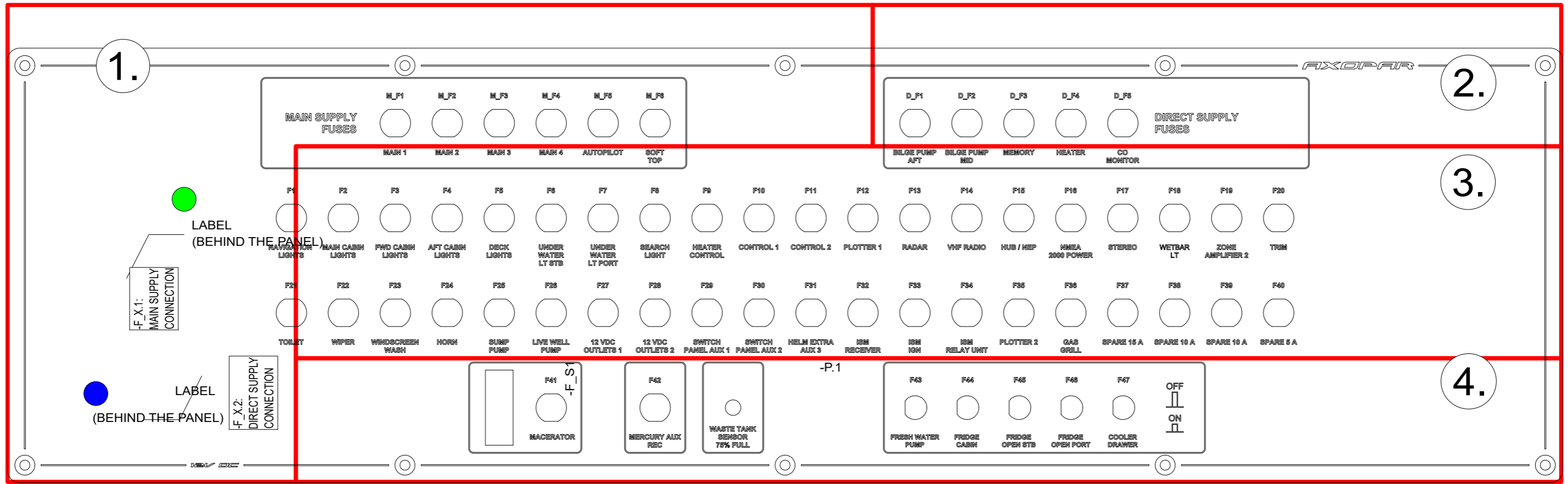

17.2.2023	RK	F9: -F18 NOW USED FOR WETBAR LT	Date	2.7.2019	NAVIX designed solutions	Axopar	SEE EXP VIEW	29595	Project ID
23.11.2023	PF	F10: 2004954; Changed livewell fuse to 3A	Drawing by	TuM		Boat	Sub-product code	Product code	
13.4.2024	PF	G11: 2005054; F47 10A->16A	Sheet rev.	11	37 MY20	FUSE UNIT	HL	126 / 213 Sheet	
Date of modification	Modified by	Description	Project rev.	G	Boat model	Title	Loc		

EXP VIEW

29595_AXOPAR_37_MY20_FUSE_UNIT_PANEL

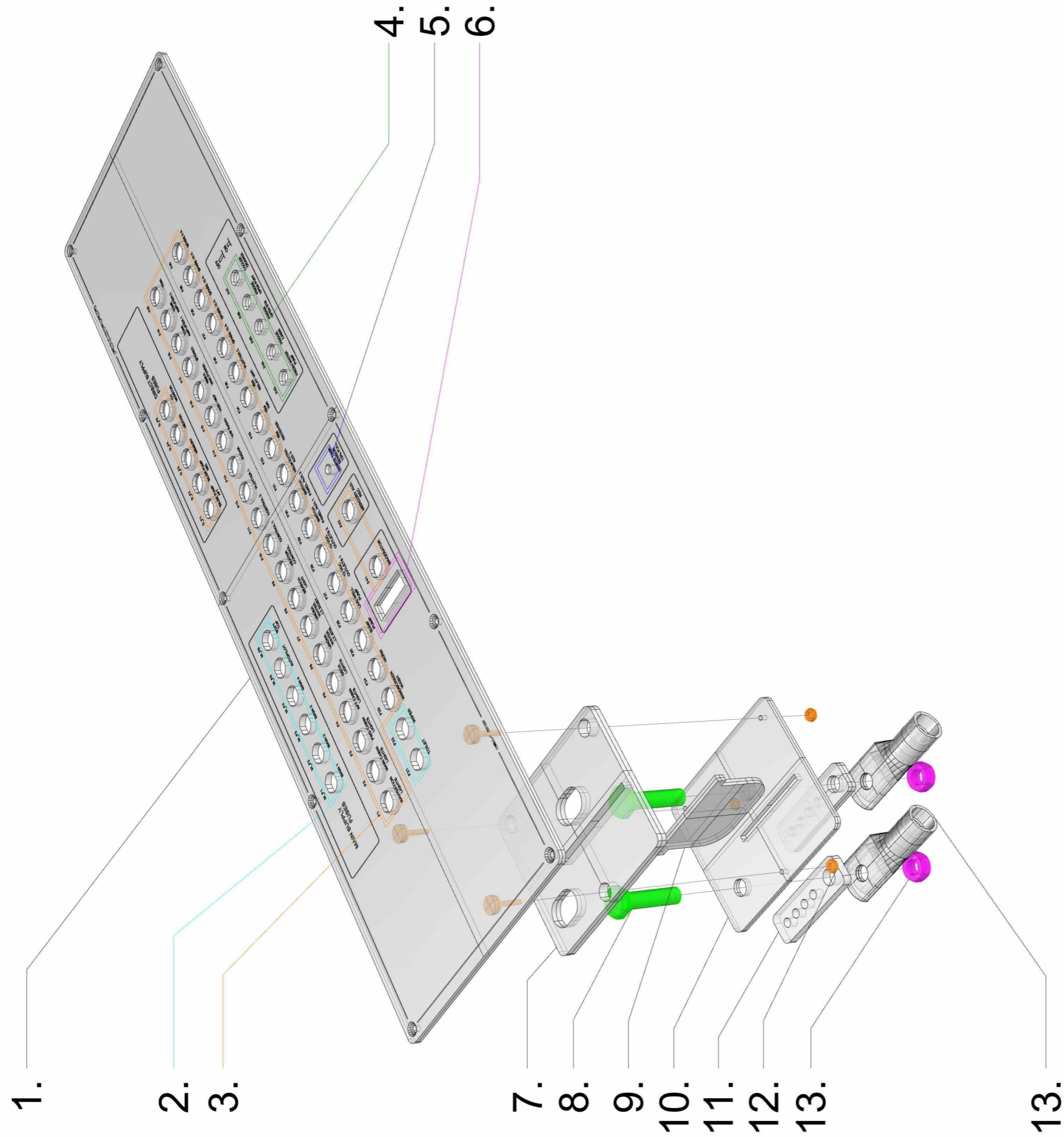

29595_AXOPAR_37_MY20_FUSE_UNIT_PANEL

- 1. 1 PCS 29916_AXOPAR_37_MY20_FUSE_UNIT_PANEL_(WOC)
- 2. 8 PCS CARLING CLB SERIES (AS IN DIAGRAM)
- 3. 45 PCS CARLING CMB SERIES (AS IN DIAGRAM)
- 4. 5 PCS ETA 1140 FUSE
- 5. 1 PC 19030253 LED PANEL MOUNT INDICATOR, SATIN CHROME BEZEL. RED. 12 VDC, 6mm 20mA, 13MCD, IP40
- 6. 1 PC ARCOLECTRIC_15...B_33.4X14.0
- 7. 1 PC 29918_AXOPAR_37_MY20_FUSE_UNIT_MS_DC_BT_M_PANEL_(WOC)
- 8. 2 PCS M10 L40
- 9. 1 PC 29920_AXOPAR_37_MY20_FUSE_UNIT_MS_DC_SPACER_PANEL_(WOC)
- 10. 1 PC 29919_AXOPAR_37_MY20_FUSE_UNIT_MS_DC_TOP_PANEL_(WOC)
- 11. 2 PCS 30167_NAVIX_LINE_VIRTAKISKO_FOUR_SPOT_SMALL
- 12. 3 PCS M4 NUT A4
- 13. 2 PCS M10 SPRING WASHER
- 2 PCS M10 NUT A4
- 14. 2 PCS CABLE SHOES (AS IN DIAGRAM)

TE 01.07.2019
 TE 11.09.2019
 MN 23.01.2020
 TE 17.02.2021

17.2.2023	RK	F9: -F18 NOW USED FOR WETBAR LT	Date	11.6.2019	 NAVIX designed solutions Copyright by	Axopar	SEE EXP. VIEW	29595	Project ID
23.11.2023	PF	F10: 2004954; Changed livewell fuse to 3A	Drawing by	TuM		Boat	Sub-product code	Product code	
13.4.2024	PF	G11: 2005054; F47 10A->16A	Sheet rev.	11		37 MY20	FUSE UNIT	HL	127 / 213
Date of modification	Modified by	Description	Project rev.	G	Boat model	Title	Loc	Sheet	

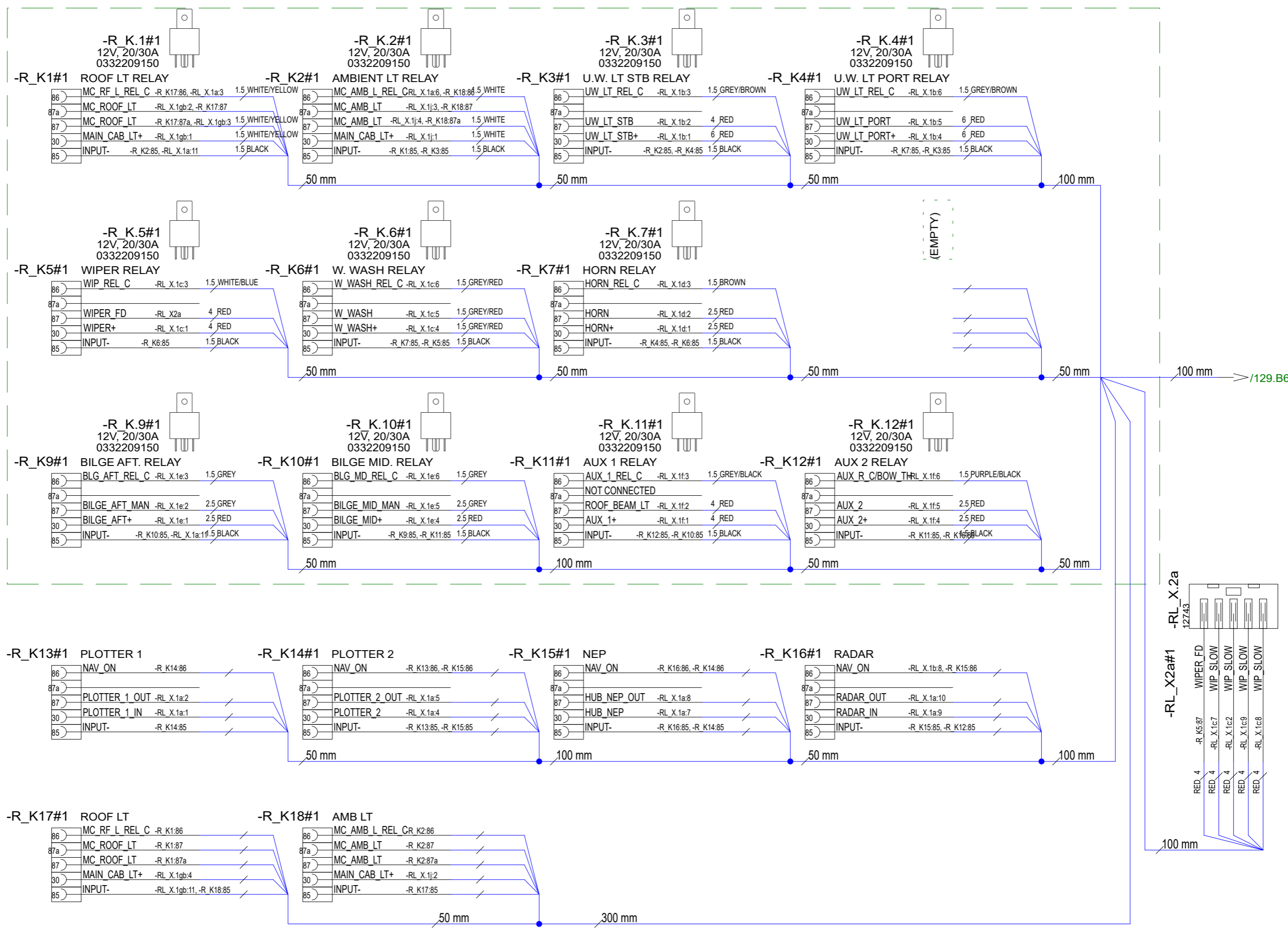

17.2.2023	RK	F5: NOT MODIFIED.	Date	22.5.2019		Axopar		29596	
13.4.2024	PF	G6: 2005054; R_K13..18 added, -RL_X.1g..j added	Drawing by	TuM		Boat		Product code	Project ID
22.9.2021	VV	E5: NOT MODIFIED / REVISION RETURNED TO REV. E.	Sheet rev.	6		37 MY20	RELAY UNIT	HL	128 / 213
Date of modification	Modified by	Description	Project rev.	G		Boat model	Title	Loc	Sheet

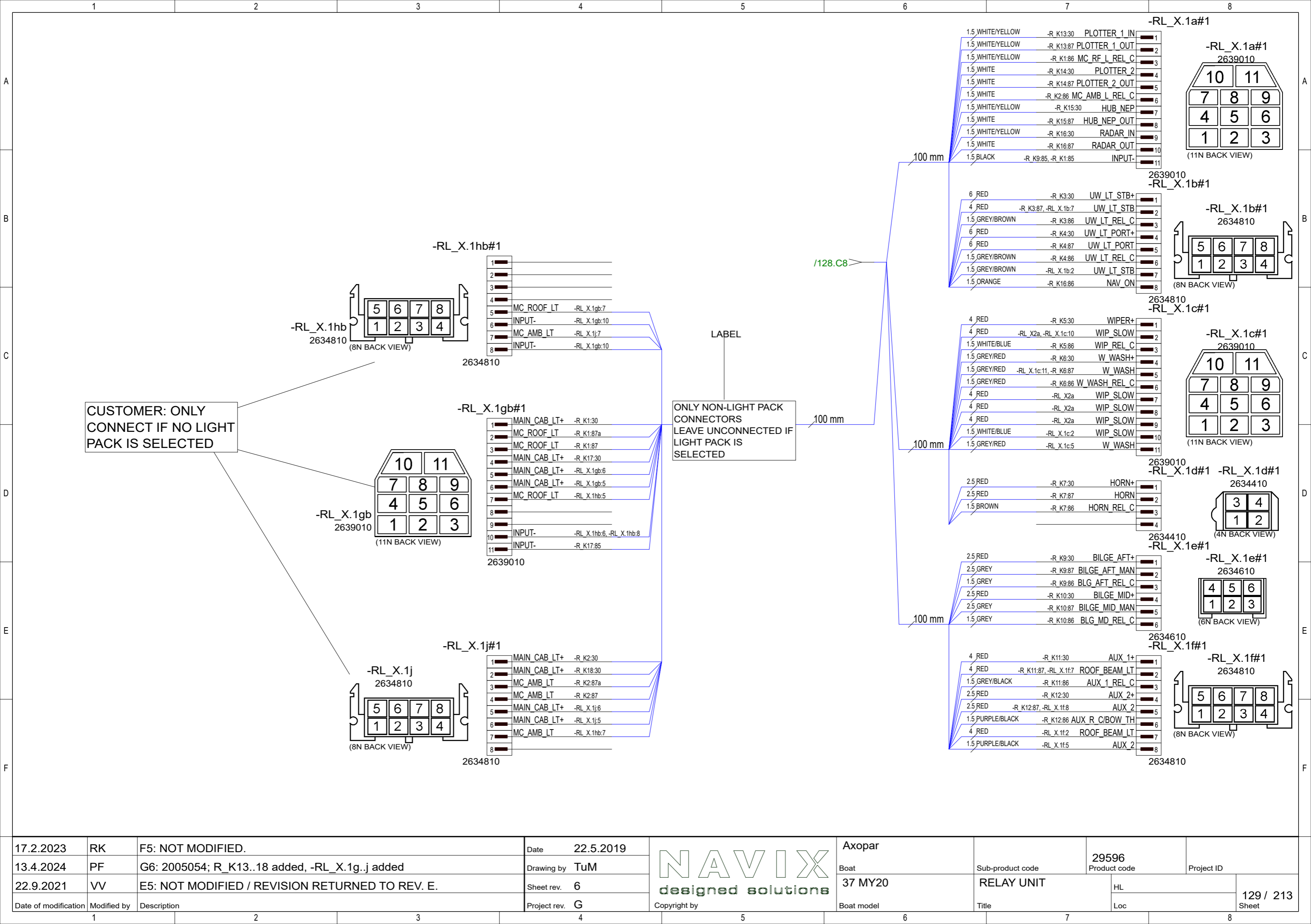

17.2.2023	RK	F5: NOT MODIFIED.	Date	22.5.2019
13.4.2024	PF	G6: 2005054; R_K13..18 added, -RL_X.1g..j added	Drawing by	TuM
22.9.2021	VV	E5: NOT MODIFIED / REVISION RETURNED TO REV. E.	Sheet rev.	6
Date of modification	Modified by	Description	Project rev.	G



Axopar	29596	Project ID	129 / 213
Boat	Sub-product code	Product code	Sheet
37 MY20	RELAY UNIT	HL	
Boat model	Title	Loc	

INSTRUCTIONS FOR ATTACHING CABLES/ RELAYS TO RELAY HOLDER:

1. PULL SECONDARY LOCK OUT OF RELAY HOLDER APPROX 1cm WITH TOOL IF NEEDED (DO NOT PULL COMPLETELY OUT)
2. MOUNT WIRES
3. PUSH SECONDARY LOCK BACK IN
4. MOUNT RELAY TO RELAY HOLDER

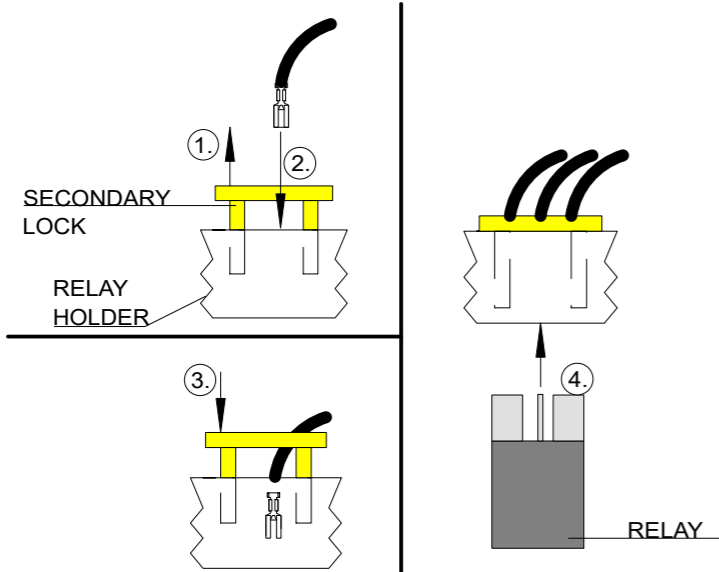

PIN ORDER

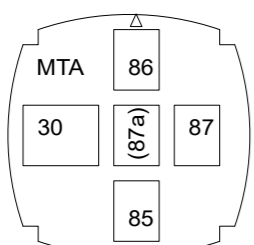

SECONDARY LOCK

SEEN FROM WIRING SIDE (BACK VIEW)

RELAY HOLDER PARTS:

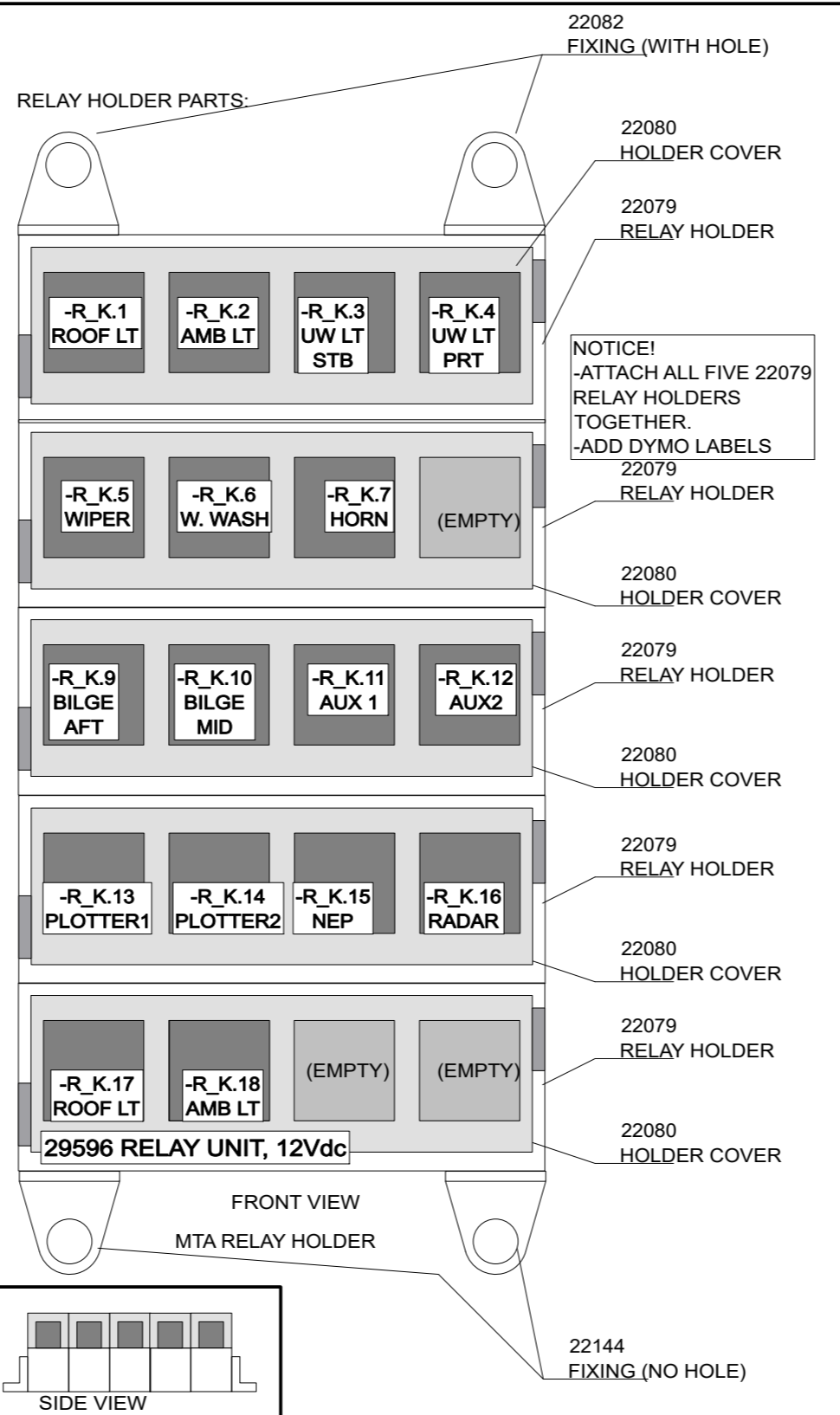

NOTICE!
-ATTACH ALL FIVE 22079 RELAY HOLDERS TOGETHER.
-ADD DYMO LABELS

NOTICE!
VERIFY THAT ALL CABLES HAVE MARKINGS SHOWN IN EXAMPLE BELOW.
EXEMPTION:
ALL <500mm WIRES AND BLACK WIRES
THIS MARKING IS NOT NEEDED.

EXAMPLE: RED 1,5mm² WIRE MARKINGS.

13.4.2024	PF	G6: 2005054; R_K13..18 added, -RL_X.1g..j added	Date 15.3.2024		Axopar		29596	
			Drawing by TuM		Boat 37 MY20	Sub-product code RELAY UNIT	Product code HL	Project ID
			Sheet rev. 6		Boat model	Title	Loc	203 / 213 Sheet
Date of modification	Modified by	Description	Project rev. G	Copyright by				

NOTICE!
 VERIFY THAT ALL CABLES HAVE MARKINGS SHOWN IN EXAMPLE BELOW.
 EXEMPTION:
 ALL <500mm WIRES, BLACK WIRES AND HI-FLEX CABLES THIS MARKING IS NOT NEEDED.

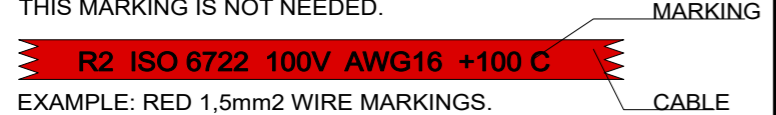

EXAMPLE: RED 1,5mm² WIRE MARKINGS.

NOTICE!
 BATTERY CABLES NEED TO ADD MARKINGS SHOWN IN EXAMPLE BELOW.
 EXEMPTION:
 ALL BLACK WIRES THIS MARKING IS NOT NEEDED.

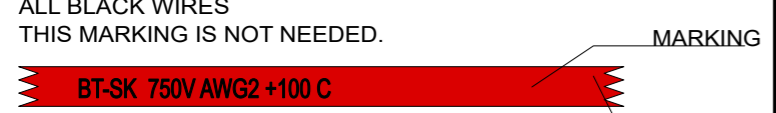

EXAMPLE: RED 50mm² WIRE MARKINGS.

MARKING SHOWN ABOVE ONLY TO CABLES LISTED BELOW.

EQUIVALENCY:	
mm ²	AWG
25 mm ²	= AWG3
35 mm ²	= AWG2
50 mm ²	= AWG0
70 mm ²	= AWG2/0
95 mm ²	= AWG3/0
120 mm ²	= 250 kcmil

LOOK FOR EQUIVALENT AWG SIZE FOR mm² AND ADD THIS TO CABLE MARKINGS.

FOR EXAMPLE:
 CABLE SIZE IS 70mm² -> MARKING AWG2/0.

NOTICE!
 INSTALL CABLES TO DEVICE SO THAT LARGEST TERMINALS ARE CLOSEST TO DEVICES CONDUCTIVE AREA.

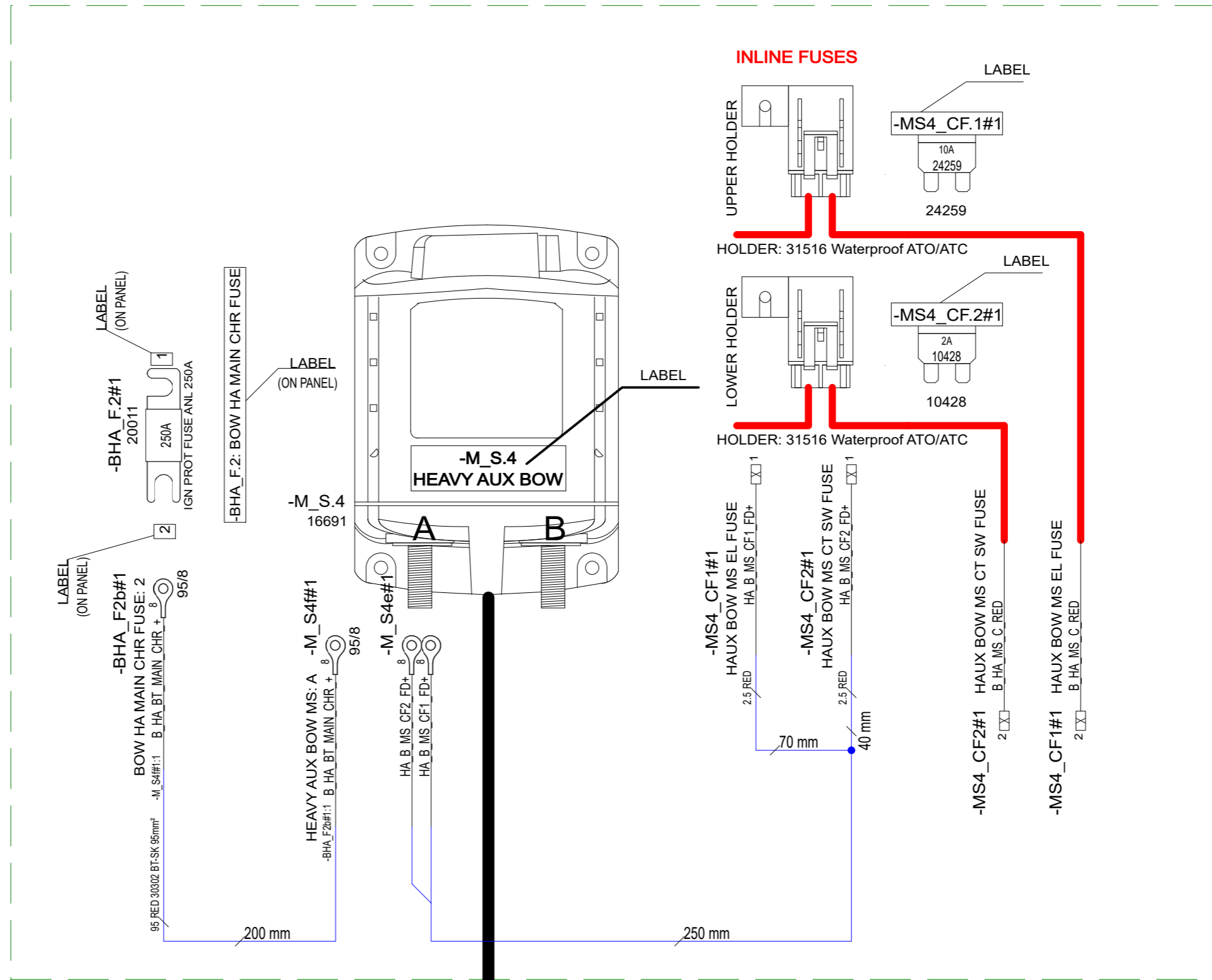
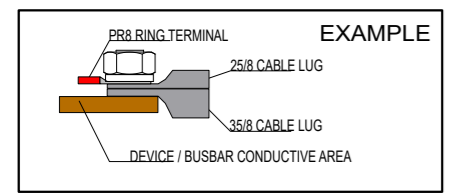

CONNECTION TO HULL HARNESS

BLACK	-M_S4c	INPUT-	1
RED	-M_S4B_HA_MS_C_RED		2
BROWN	-M_S4cB_HA_MS_C_BRN		3
YELLOW	-M_S4cB_HA_MS_C_YEL		4
ORANGE	-M_S4cB_HA_MS_C_ORG		5
			6

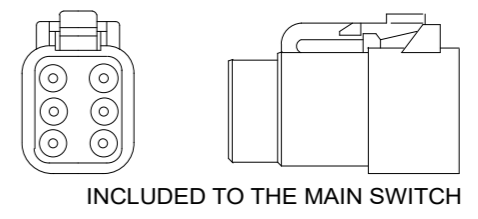

INCLUDED TO THE MAIN SWITCH

DTM06-6S

15.4.2024	PF	G6: 2005054; Not modified	Date
22.9.2021	VV	E5: NOT MODIFIED / REVISION RETURNED TO REV. E.	Drawing by TuM
17.2.2023	RK	F6: FUSE HOLDERS CHANGED TO 31516.	Sheet rev. 6
Date of modification	Modified by	Description	Project rev. G



Axopar	SEE EXP VIEW	29597	Project ID
Boat	Sub-product code	Product code	
37 MY20	BOW HEAVY AUX MAIN SWITCH UNIT	HL	130 / 213
Boat model	Title	Loc	Sheet

GENERAL LAYOUT / LABELS / CABLE ROUTES

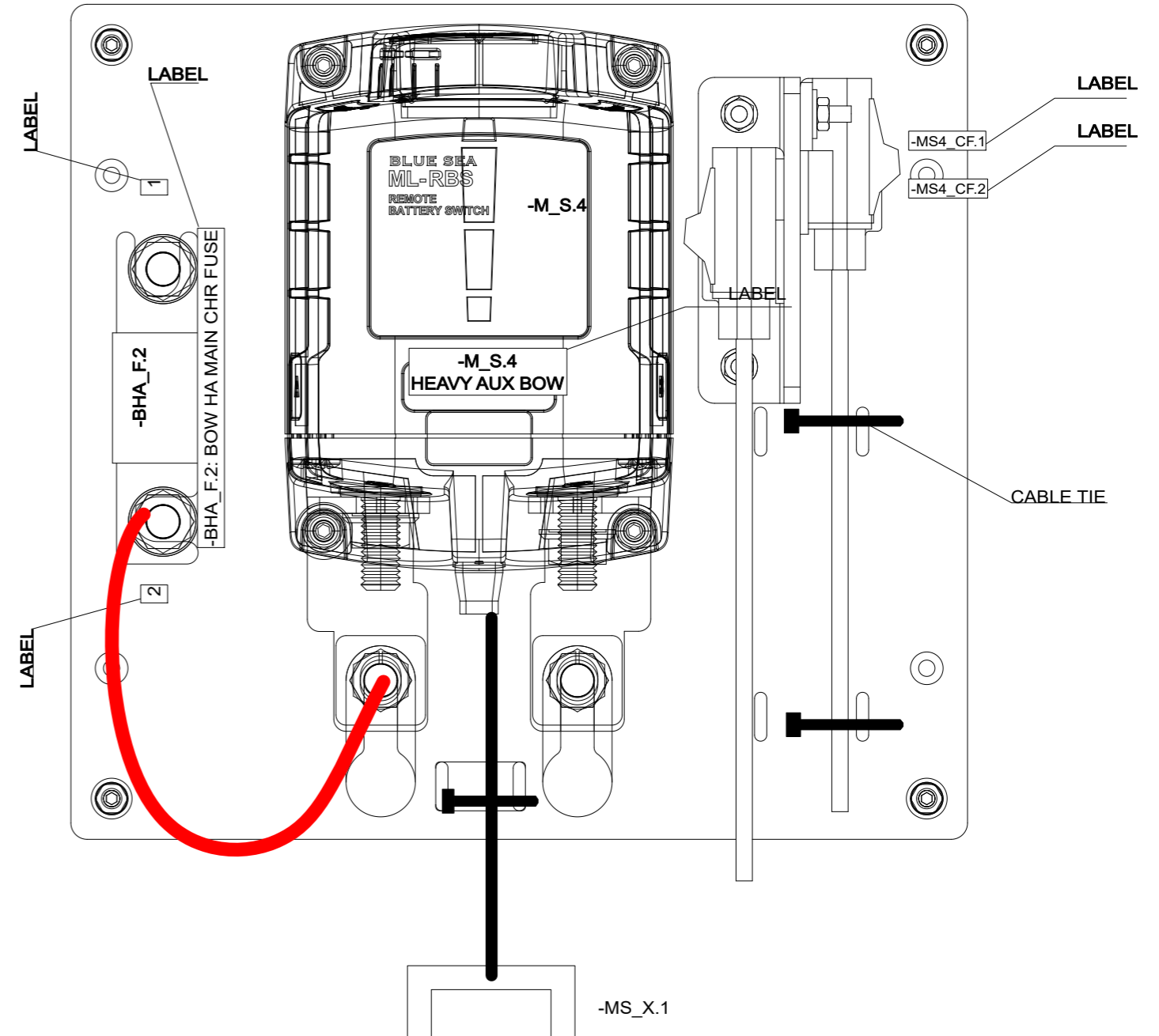
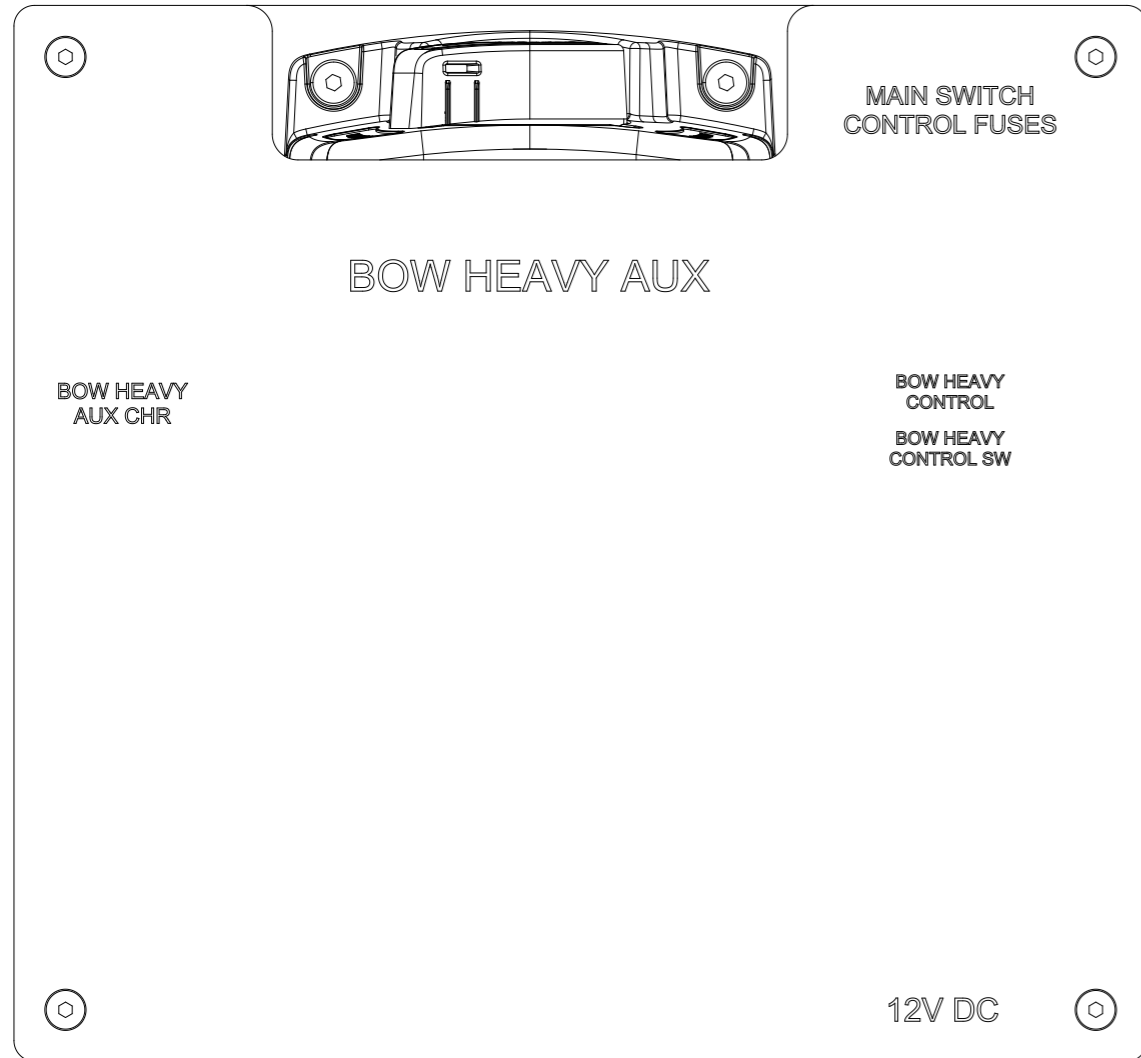

15.4.2024	PF	G6: 2005054; Not modified
22.9.2021	VV	E5: NOT MODIFIED / REVISION RETURNED TO REV. E.
17.2.2023	RK	F6: FUSE HOLDERS CHANGED TO 31516.
Date of modification	Modified by	Description

Date	
Drawing by	TuM
Sheet rev.	6
Project rev.	G

NAVIX
designed solutions
Copyright by

Axopar
Boat
37 MY20
Boat model

SEE EXP VIEW
Sub-product code
BOW HEAVY AUX
MAIN SWITCH UNIT
Title

29597
Product code
HL
Loc

Project ID
131/ 213
Sheet

EXP VIEW

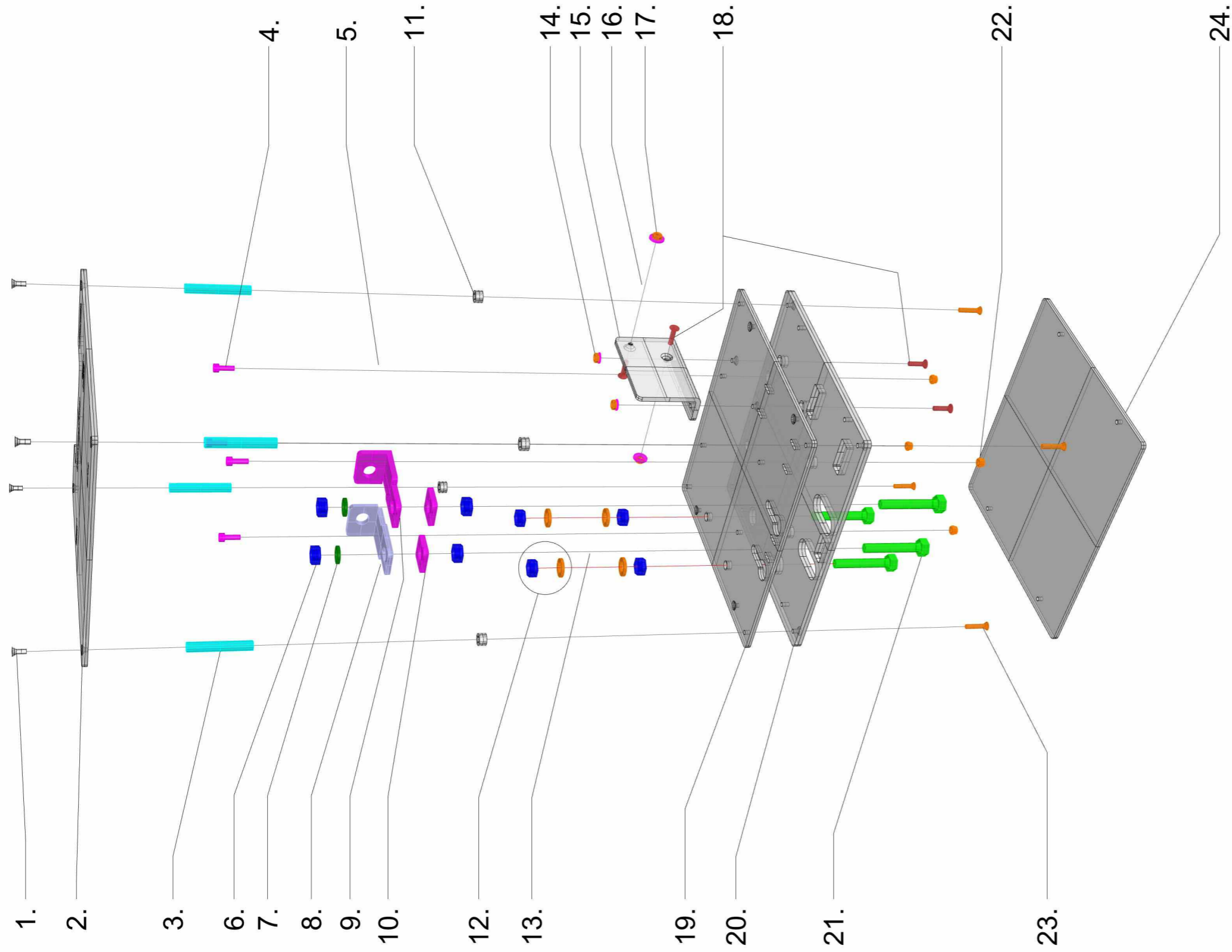

29597_AXOPAR_37_MY20_BOW_HEAVY_AUX_MAIN_SWITCH_UNIT

29597_AXOPAR_37_MY20_BOW_HEAVY_AUX_MAIN_SWITCH_UNIT

- 1. 4PCS VMI30914 Countersunk Head Screw M4x10 DIN7991
- 2. 1PC
- 29868_AXOPAR_37_MY20_BOW_HEAVY_AUX_MSU_COVER_(WOC)
- 3. 4PCS VMI32041 Extension Bolt M4-L50mm
- 4. 4PCS VMI30944 HEX SOCKET HEAD CAP SCREW M4X12 DIN912
- 5. 1PC BLUE SEA ML-RBS
- 6. 4PCS VMI32012 HEX NUT M8 DIN934
- 7. 2PCS VMI32011 SPRING LOCK WASHER M8 DIN127
- 8. 1PC 20329_VIRTAKISKO_BLUE_SEA_ML_SHORT_LEFT
- 9. 1PC 20330_VIRTAKISKO_BLUE_SEA_ML_SHORT_RIGHT
- 10. 2PCS 3667
- 11. 4PCS 18455_NAVIX_LINE_6mm_ABS_SPACER_FOR_M5
- 12. 4PCS VMI32015 Flat Washer for HEX bolts and nuts M8 DIN125A
4PCS VMI32012 HEX NUT M8 DIN934
- 13. 1PC ANL (as in diagram)
- 14. 2PCS VMI30904 SPRING LOCK WASHER M4 DIN127
- 2PCS VMI30905 HEX NUT M4 DIN934
- 15. 1PC
- 38604_NAVIX_LINE_BRACKET_FOR_31516_FUSEHOLDER_(WOC)

- 16. 2PCS 31516_Fuseholder waterproof ATO ATC 5065B-BSS
- 17. 2PCS VMI30906 Flat Washer for HEX bolts and nuts M4 DIN125A
2PCS VMI30905 HEX NUT M4 DIN934
- 18. 4PCS VMI30917 COUNTERSUNK HEAD SCREW HEX SOCKET M4X16
DIN7991

- 19. 1PC 29869_AXOPAR_37_MY20_BOW_HEAVY_AUX_MSU_TOP_(WOC)
- 20. 1PC 29870_AXOPAR_37_MY20_BOW_HEAVY_AUX_MSU_MID_(WOC)
- 21. 4PCS VMI32021 HEX BOLT FULL THREAD M8X50 DIN933
- 22. 4PCS VMI30818 Self-locking Hexagon Nut M4 DIN985
- 23. 4PCS VMI30918 Countersunk Head Screw M4x20 DIN7991
- 24. 1PC
- 29871_AXOPAR_37_MY20_BOW_HEAVY_AUX_MSU_BOTTOM_(WOC)
- 4PCS CONNECT 29871 WITH CABLE

TIE DURING TRANSPORTATION

TE 10.06.2019
TE 15.03.2023

15.4.2024	PF	G6: 2005054; Not modified	Date
22.9.2021	VV	E5: NOT MODIFIED / REVISION RETURNED TO REV. E.	Drawing by TuM
17.2.2023	RK	F6: FUSE HOLDERS CHANGED TO 31516.	Sheet rev. 6
Date of modification	Modified by	Description	Project rev. G



Axopar
Boat
37 MY20
Boat model

SEE EXP VIEW	29597	
Sub-product code	Product code	Project ID
BOW HEAVY AUX MAIN SWITCH UNIT	HL	132 / 213
Title	Loc	Sheet

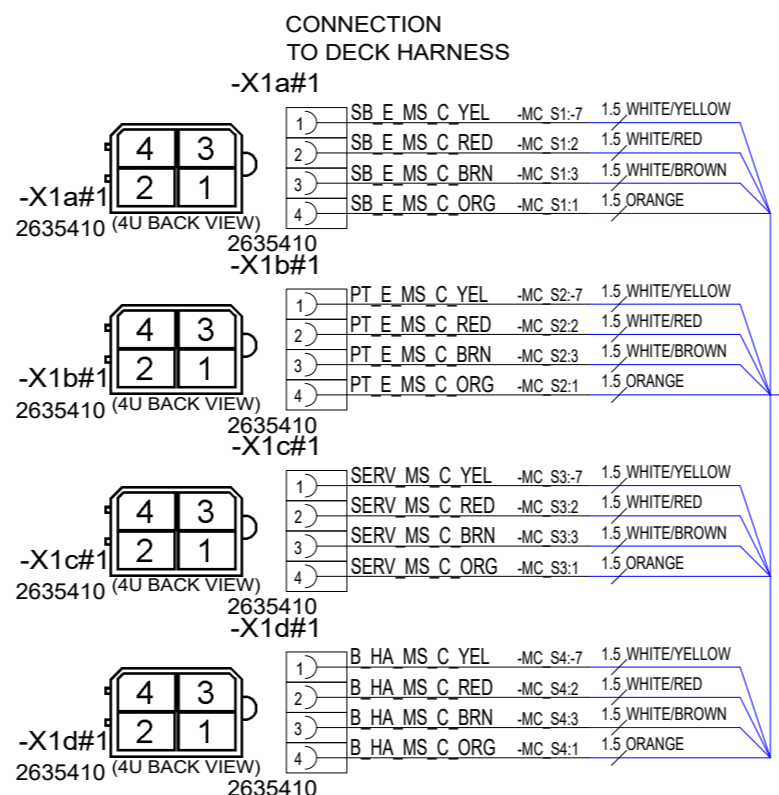
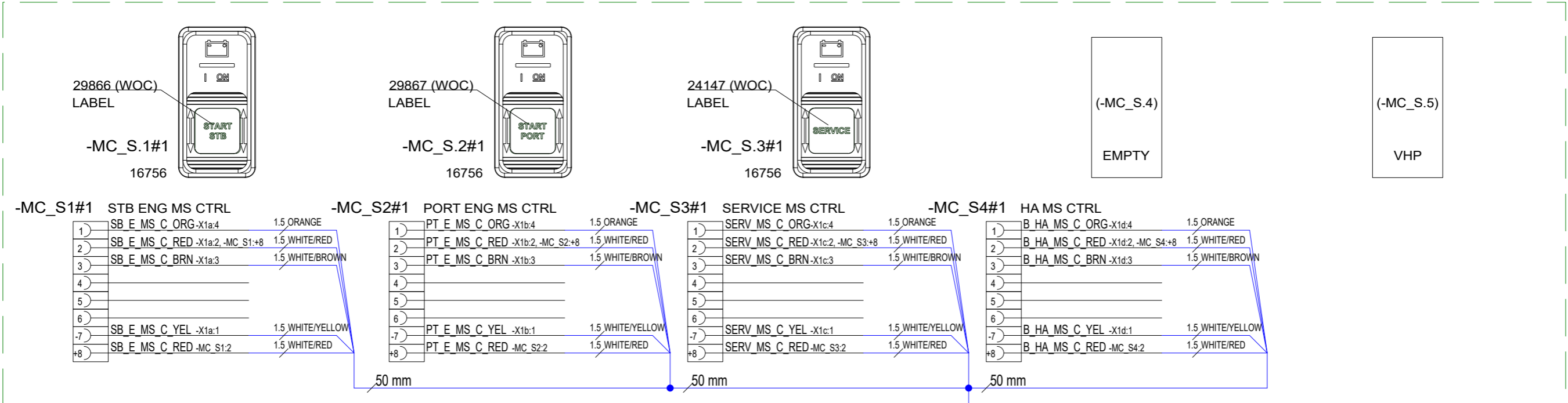
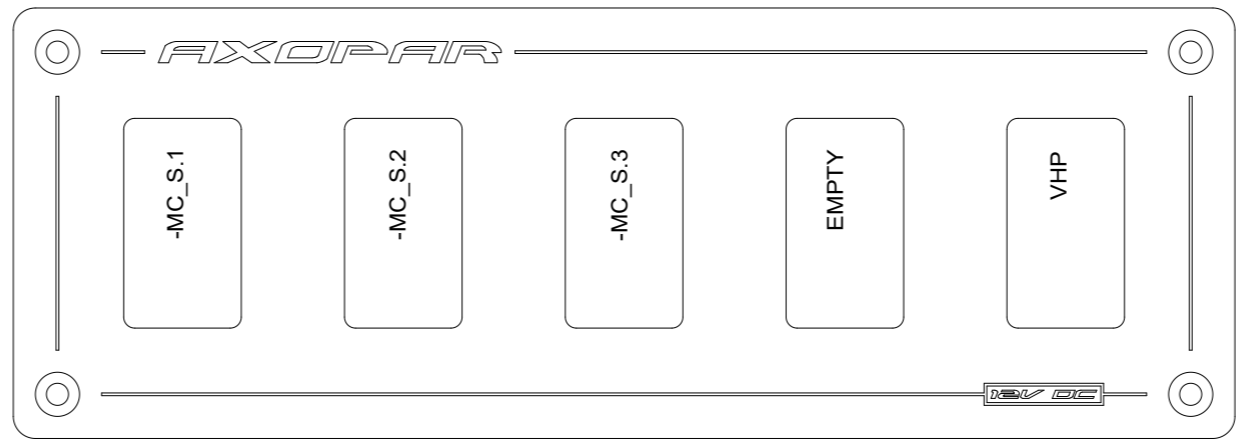

NOTICE!
 VERIFY THAT ALL CABLES HAVE MARKINGS SHOWN IN EXAMPLE BELOW.
 EXEMPTION:
 ALL <500mm WIRES AND BLACK WIRES THIS MARKING IS NOT NEEDED.

EXAMPLE: RED 1,5mm² WIRE MARKINGS.

22.9.2021	TT	E3: NOT MODIFIED / REVISION RETURNED TO REV. E.	Date	22.5.2019		Axopar	29865	29599	Project ID
17.2.2023	RK	F3: NOT MODIFIED.	Drawing by	TuM		Boat	Sub-product code	Product code	
19.4.2024	PF	G3: 2005054; Not modified	Sheet rev.	3		37 MY20	MAIN SWITCH CONTROL PANEL Title	HL	133 / 213 Sheet
Date of modification	Modified by	Description	Project rev.	G		Boat model		Loc	

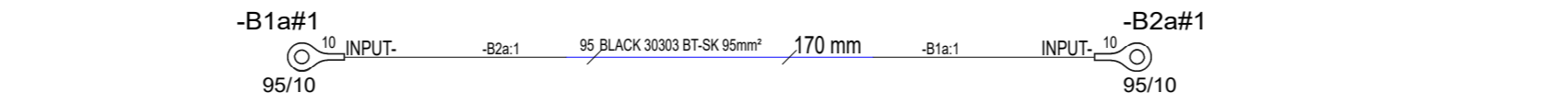
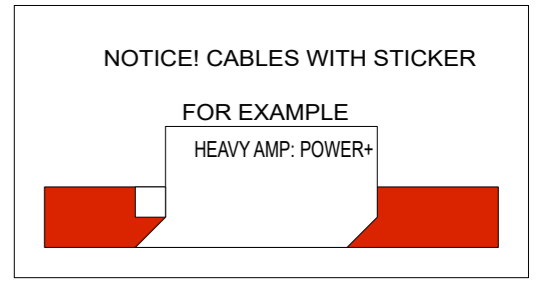
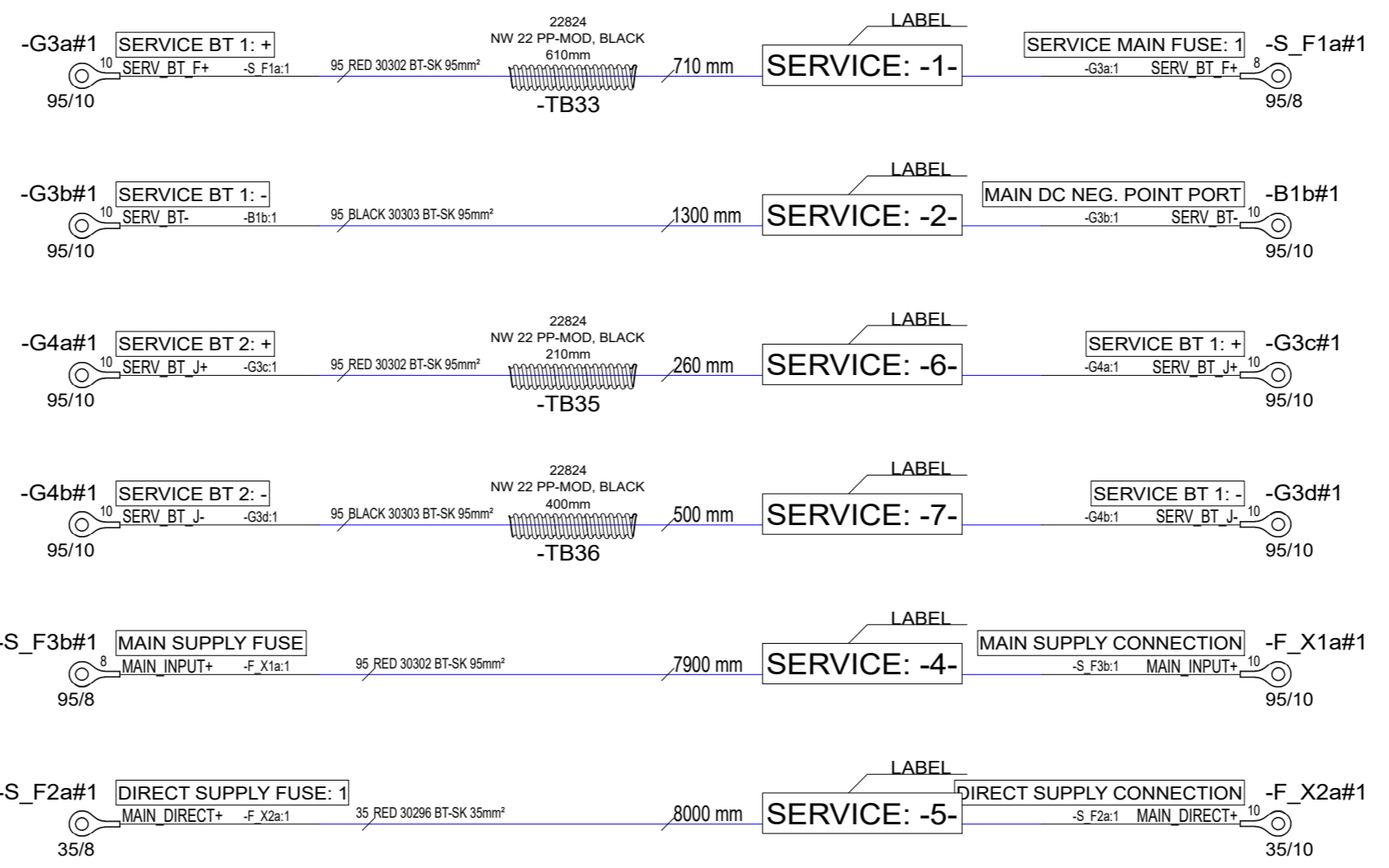

NOTICE!
BATTERY CABLES NEED TO ADD MARKINGS SHOWN IN EXAMPLE BELOW.
EXEMPTION:
ALL BLACK WIRES
THIS MARKING IS NOT NEEDED.

EXAMPLE: RED 50mm² WIRE MARKINGS.

MARKING SHOWN ABOVE ONLY TO CABLES LISTED BELOW.

EQUIVALENCY:	
mm ²	AWG
25 mm ²	= AWG3
35 mm ²	= AWG2
50 mm ²	= AWG0
70 mm ²	= AWG2/0
95 mm ²	= AWG3/0
120 mm ²	= 250 kcmil

LOOK FOR EQUIVALENT AWG SIZE FOR mm² AND ADD THIS TO CABLE MARKINGS.
FOR EXAMPLE:
CABLE SIZE IS 70mm² --> MARKING AWG2/0.

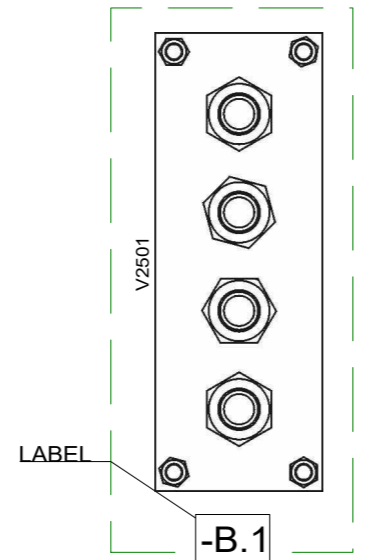

MAIN DC NEG. POINT PORT

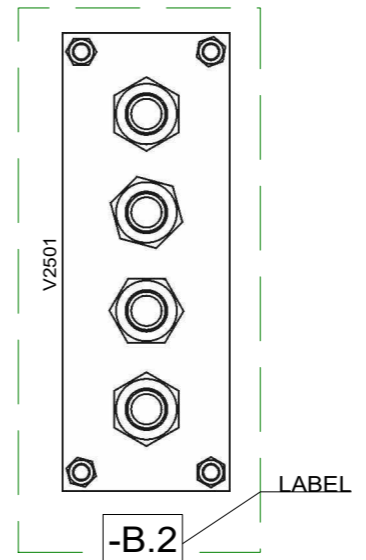

MAIN DC NEG. POINT STB

22.9.2021	VV	E4: NOT MODIFIED / REVISION RETURNED TO REV. E.	Date	22.5.2019		Axopar		29601	
17.2.2023	RK	F4: NOT MODIFIED.	Drawing by	TuM		Boat		Product code	Project ID
19.4.2024	PF	G4: 2005054; Not modified	Sheet rev.	4		37 MY20	Sub-product code		
Date of modification	Modified by	Description	Project rev.	G	Copyright by	Boat model	SERVICE MAIN SUPPLY CABLES Title	HL Loc	135 / 213 Sheet

NOTICE!
BATTERY CABLES NEED TO ADD MARKINGS
SHOWN IN EXAMPLE BELOW.

EXEMPTION:
ALL BLACK WIRES
THIS MARKING IS NOT NEEDED.

R2 ISO 6722 100V AWG6 +100 C
EXAMPLE: RED 16mm2 WIRE MARKINGS.

MARKING SHOWN ABOVE ONLY TO CABLES LISTED BELOW.

EQUIVALENCY:

mm2	AWG
10 mm2	= AWG8
16 mm2	= AWG6
25 mm2	= AWG3
35 mm2	= AWG2

LOOK FOR EQUIVALENT AWG SIZE FOR mm2
AND ADD THIS TO CABLE MARKINGS.

FOR EXAMPLE:
CABLE SIZE IS 25mm2 --> MARKING AWG3.

NOTICE! CABLES WITH STICKER

FOR EXAMPLE
HEAVY AMP: POWER+

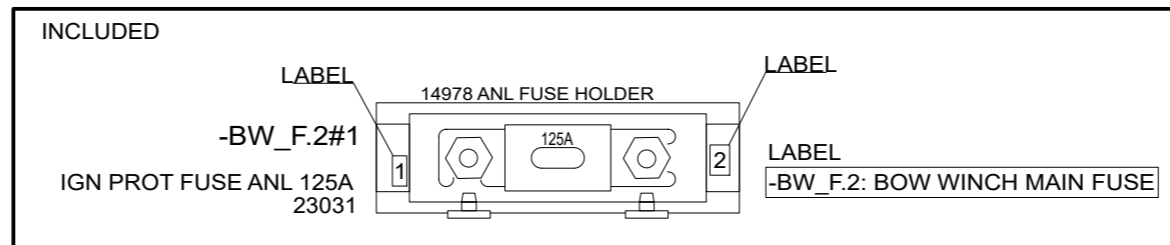
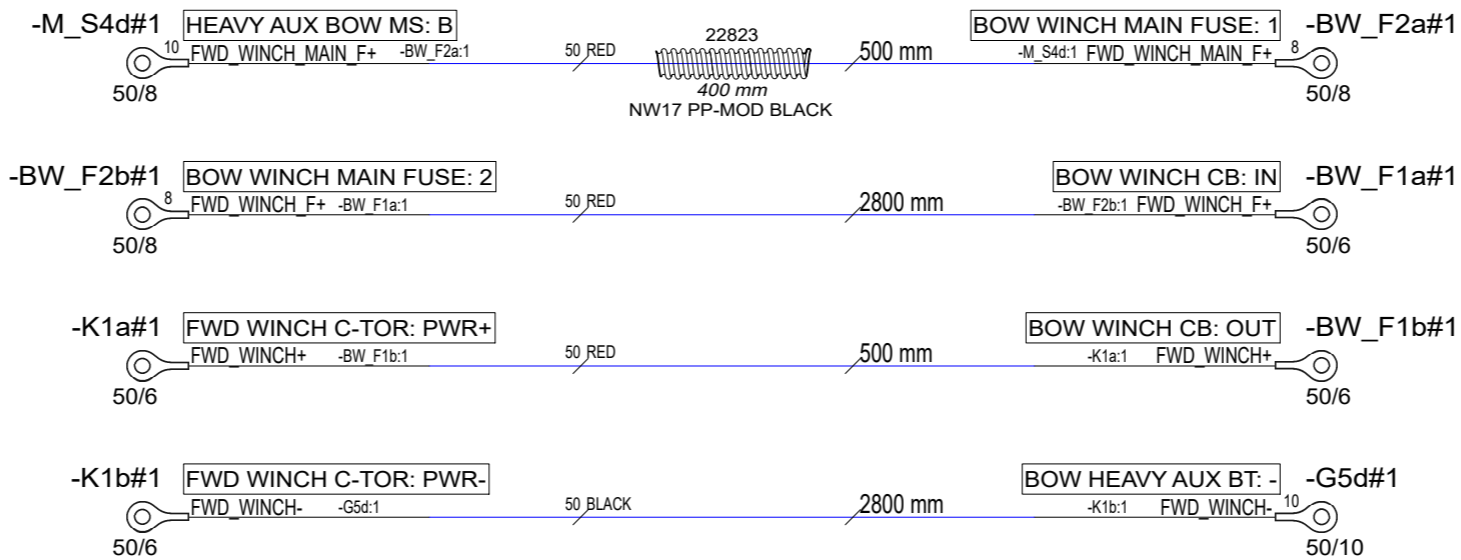

LABEL INSTRUCTIONS

NOTICE! PUT LABELS TO FUSE HOLDER
BASE - NOT TO COVER.

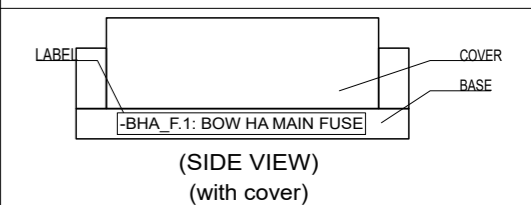
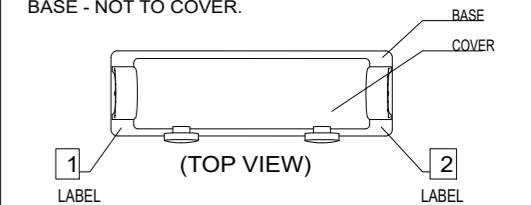

19.4.2024	PF	G4: 2005054; Not modified
17.2.2023	RK	F3: NOT MODIFIED.
17.10.2023	PF	F4: 2004916; Cable and fuse sizes increased
Date of modification	Modified by	Description

Date	22.5.2019
Drawing by	TuM
Sheet rev.	4
Project rev.	G

NAVIX
designed solutions
Copyright by

Axopar
Boat
37 MY20
Boat model

Sub-product code	29603	Product code	Project ID
BOW WINCH CABLE SET		HL	138 / 213
Title	Loc	Sheet	

NOTICE!
BATTERY CABLES NEED TO ADD MARKINGS
SHOWN IN EXAMPLE BELOW.

EXEMPTION:
ALL BLACK WIRES
THIS MARKING IS NOT NEEDED.

R2 ISO 6722 100V AWG6 +100 C
EXAMPLE: RED 16mm² WIRE MARKINGS.

MARKING SHOWN ABOVE ONLY TO CABLES LISTED BELOW.

LOOK FOR EQUIVALENT AWG SIZE FOR mm²
AND ADD THIS TO CABLE MARKINGS.

FOR EXAMPLE:
CABLE SIZE IS 25mm² --> MARKING AWG3.

EQUIVALENCY:

mm ²	=	AWG
10 mm ²	=	AWG8
16 mm ²	=	AWG6
25 mm ²	=	AWG3
35 mm ²	=	AWG2

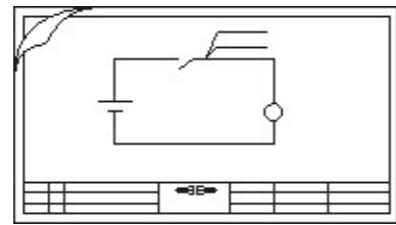

DOCUMENTS INCLUDED:

29604 BATTERY BOX
ANCH WINCH CABLE SET

NOTICE! CABLES WITH STICKER

FOR EXAMPLE
HEAVY AMP: POWER+

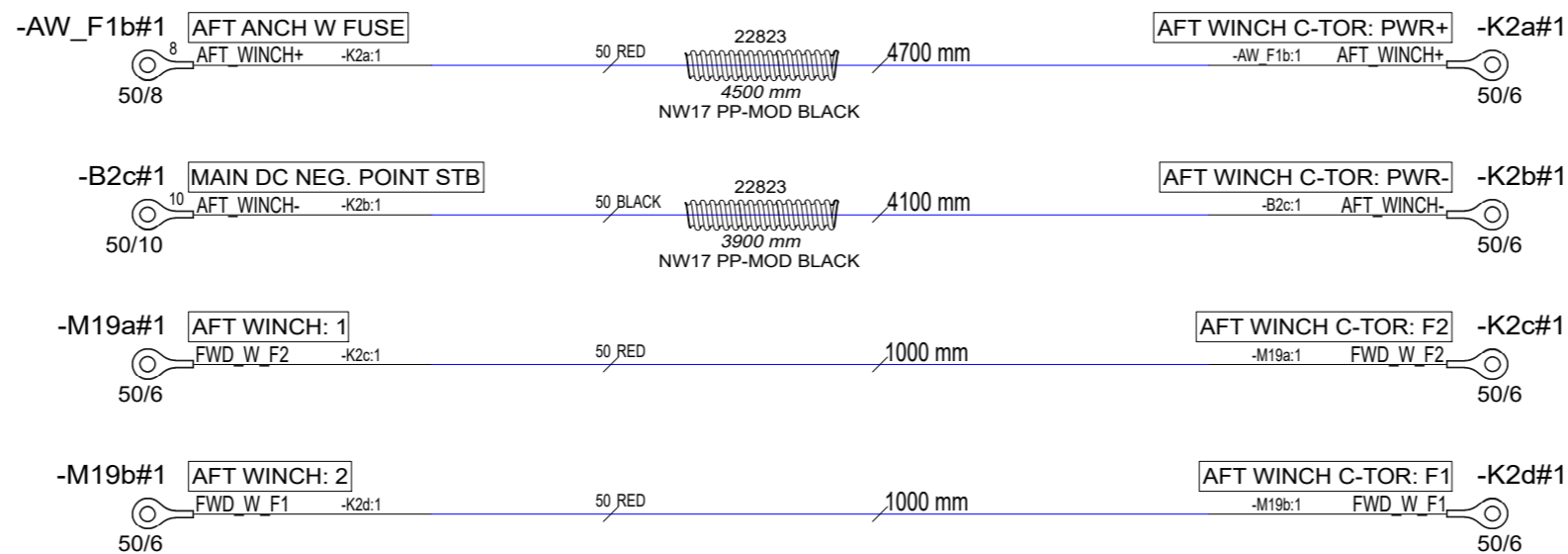

19.4.2024	PF	G4: 2005054; Not modified
17.2.2023	RK	F3: NOT MODIFIED.
17.10.2023	PF	F4: 2004916; Cable sizes increased
Date of modification	Modified by	Description

Date	22.5.2019
Drawing by	TuM
Sheet rev.	4
Project rev.	G



Copyright by

Axopar
Boat
37 MY20
Boat model

29604	Product code	Project ID
AFT WINCH CABLE SET	HL	139 / 213
Title	Loc	Sheet

NOTICE!
BATTERY CABLES NEED TO ADD MARKINGS
SHOWN IN EXAMPLE BELOW.

EXEMPTION:
ALL BLACK WIRES
THIS MARKING IS NOT NEEDED.



MARKING SHOWN ABOVE ONLY TO CABLES LISTED BELOW.

LOOK FOR EQUIVALENT AWG SIZE FOR mm2
AND ADD THIS TO CABLE MARKINGS.

FOR EXAMPLE:
CABLE SIZE IS 25mm2 --> MARKING AWG3.

EQUIVALENCY:

mm2	AWG
10 mm2	= AWG8
16 mm2	= AWG6
25 mm2	= AWG3
35 mm2	= AWG2

NOTICE! CABLES WITH STICKER

FOR EXAMPLE
HEAVY AMP: POWER+



HEAVY AMPLIFIER CABLES

(TO TOP OF PACKAGE)

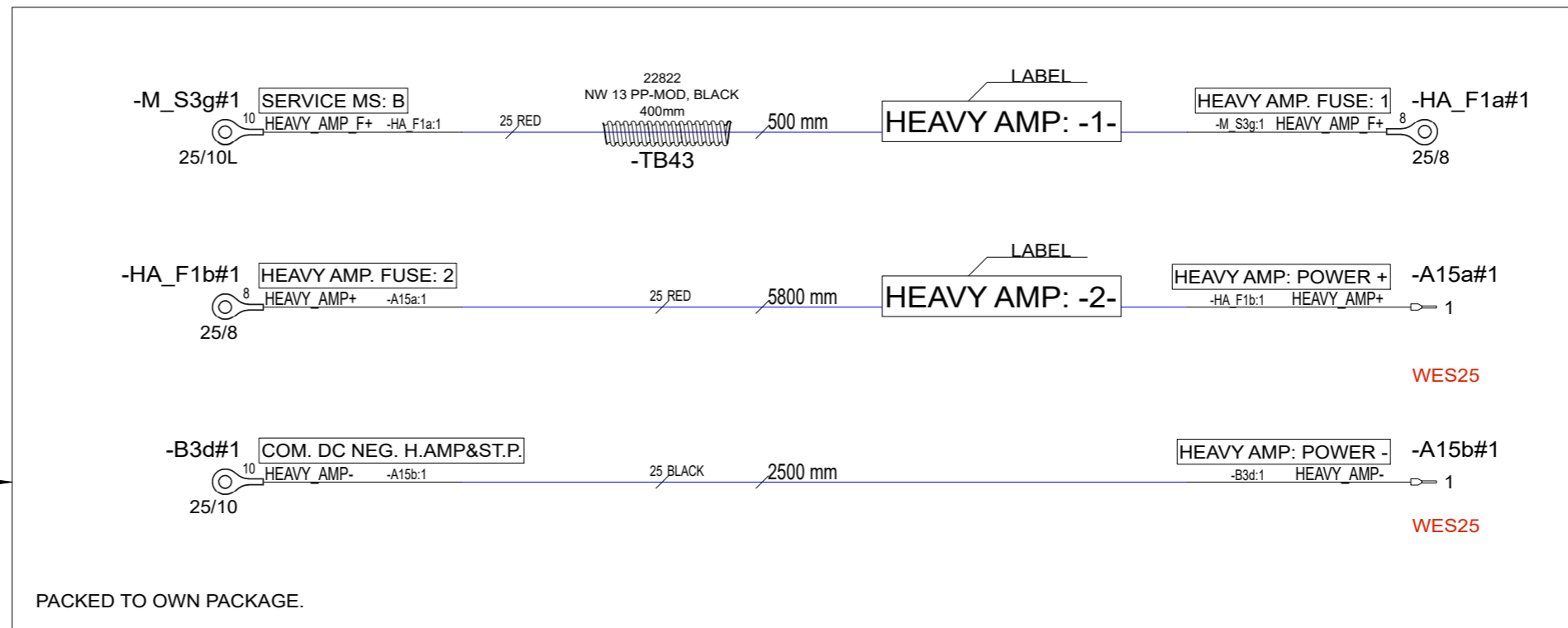

22.9.2021	VV	E4: NOT MODIFIED / REVISION RETURNED TO REV. E.
17.2.2023	RK	F5: LENGTH MODIFICATIONS.
19.4.2024	PF	G5: 2005054; Not modified
Date of modification	Modified by	Description

Date	21.5.2019
Drawing by	TuM
Sheet rev.	5
Project rev.	G

NAVIX
designed solutions
Copyright by

Axopar	29605	Project ID
Boat	37 MY20	Sub-product code
Boat model	HEAVY AMPLIFIER CABLES	Product code
	HL	Loc
		140 / 213
		Sheet

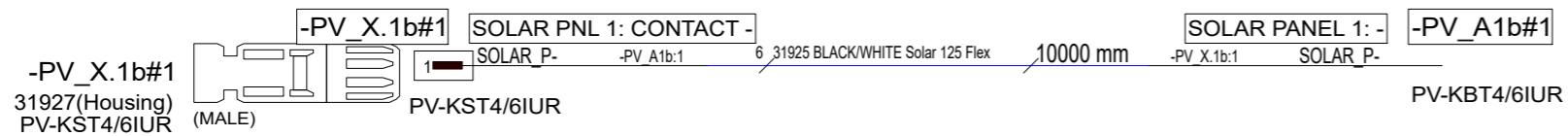
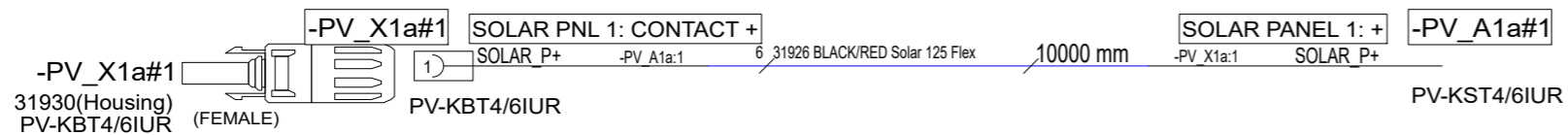

DELIVERED SEPARATELY

<p>SOLAR CABLE CONNECTORS</p> <p>31927 Solar Connector MC4 Pin inc. housing</p> <p>-PV_A1a#1 31927(Housing) PV-KST4/6IUR (MALE)</p> <p>31927(Connector) (PIN)</p>	<p>SOLAR PANEL CONNECTORS</p> <p>31930 Solar Connector MC4 Socket inc. housing</p> <p>-PV_A,1a 31930(Housing) PV-KBT4/6IUR (FEMALE)</p> <p>31927(Connector) (SOCKET)</p>
<p>31930 Solar Connector MC4 Socket inc. housing</p> <p>-PV_A1b#1 31930(Housing) PV-KBT4/6IUR (FEMALE)</p> <p>31930(Connector) (SOCKET)</p>	<p>31927 Solar Connector MC4 Pin inc. housing</p> <p>-PV_A,1b 31927(Housing) PV-KST4/6IUR (MALE)</p> <p>31930(Connector) (PIN)</p>

LABEL
SOLAR PANEL CABLES
 (TO TOP OF PACKAGE)

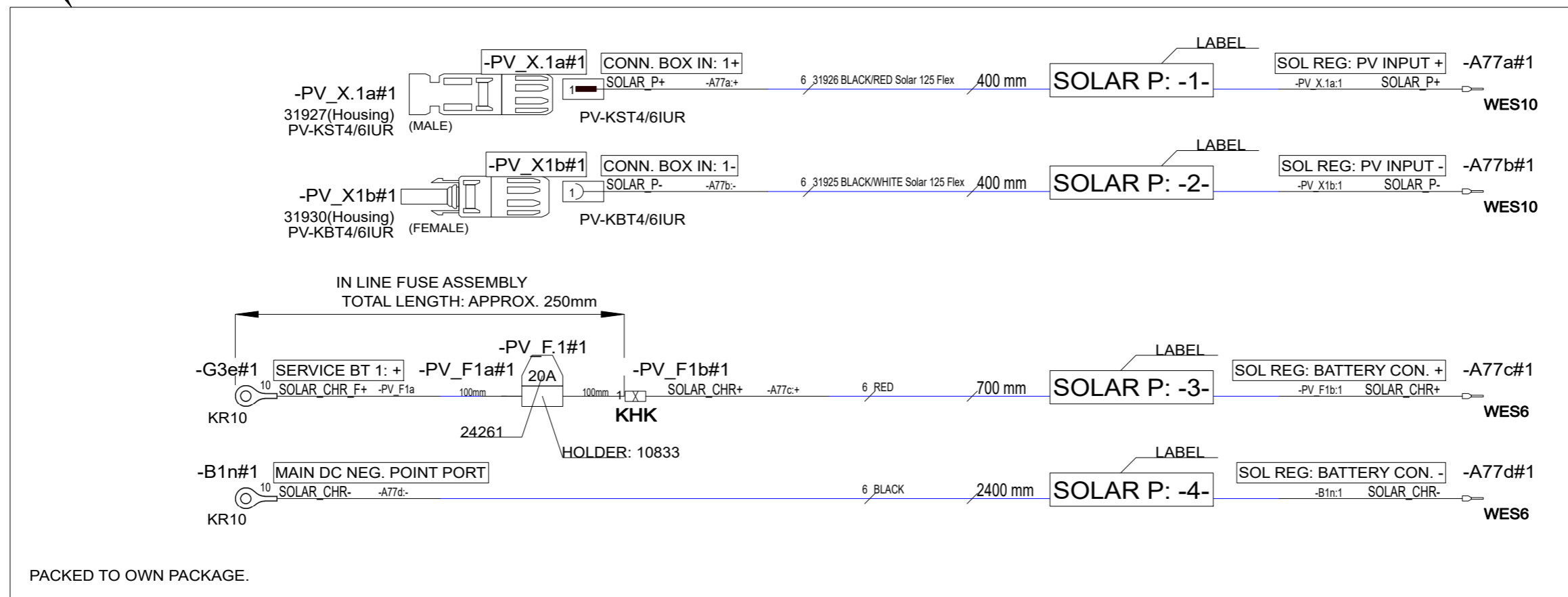

NOTICE! CABLES WITH STICKER
 FOR EXAMPLE
 POINT -A-

DOCUMENTS INCLUDED:

- 29606 BATTERY BOX
- SOLAR PANEL CABLES

22.9.2021	VV	E4: NOT MODIFIED / REVISION RETURNED TO REV. E.	Date	21.5.2019		Axopar		29606	
17.2.2023	RK	F4: NOT MODIFIED.	Drawing by	TuM		Boat		Product code	Project ID
19.4.2024	PF	G4: 2005054; Not modified	Sheet rev.	4		37 MY20	SOLAR PANEL CABLES	HL	
Date of modification	Modified by	Description	Project rev.	G		Boat model	Title	Loc	141/ 213 Sheet

NOTICE! CABLES WITH STICKER

FOR EXAMPLE
HEAVY AMP: POWER+

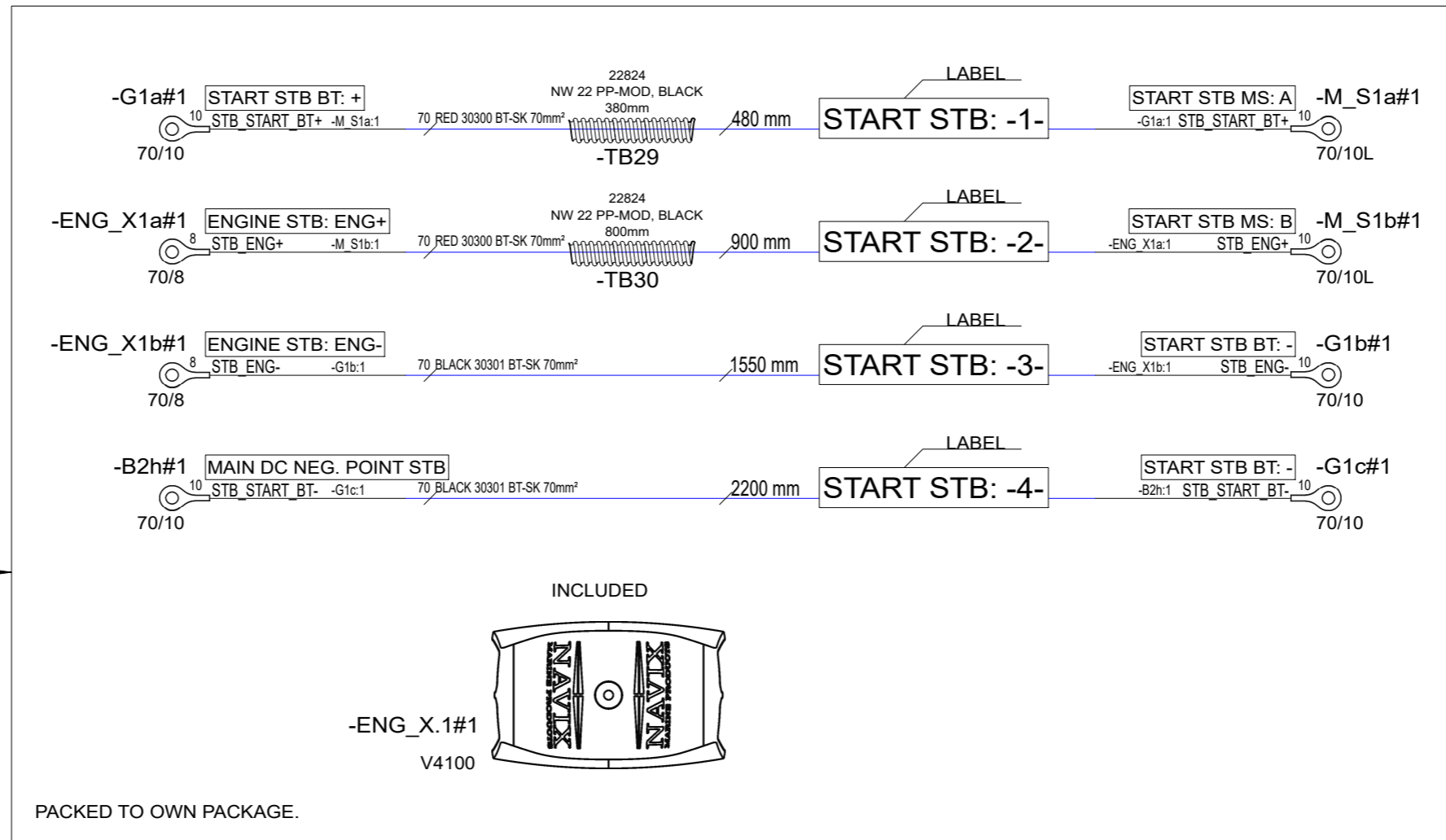

START STB CABLES

LABEL

(TO TOP OF PACKAGE)

NOTICE!
BATTERY CABLES NEED TO ADD MARKINGS
SHOWN IN EXAMPLE BELOW.

EXEMPTION:
ALL BLACK WIRES
THIS MARKING IS NOT NEEDED.

EXAMPLE: RED 50mm² WIRE MARKINGS.

MARKING SHOWN ABOVE ONLY TO CABLES LISTED BELOW.

EQUIVALENCY:	
mm ²	AWG
25 mm ²	= AWG3
35 mm ²	= AWG2
50 mm ²	= AWG0
70 mm ²	= AWG2/0
95 mm ²	= AWG3/0
120 mm ²	= 250 kcmil

LOOK FOR EQUIVALENT AWG SIZE FOR mm²
AND ADD THIS TO CABLE MARKINGS.

FOR EXAMPLE:
CABLE SIZE IS 70mm² --> MARKING AWG2/0.

19.4.2024	PF	G5: 2005054; Not modified	Date	6.7.2019
22.9.2021	VV	E5: NOT MODIFIED / REVISION RETURNED TO REV. E.	Drawing by	TuM
17.2.2023	RK	F5: NOT MODIFIED.	Sheet rev.	5
Date of modification	Modified by	Description	Project rev.	G



Axopar	29607	Project ID
Boat	37 MY20	Sub-product code
Boat model	BATTERY BOX CABLES STANDARD	Product code
	HL	142 / 213
	Loc	Sheet

NOTICE! CABLES WITH STICKER

FOR EXAMPLE
HEAVY AMP: POWER+

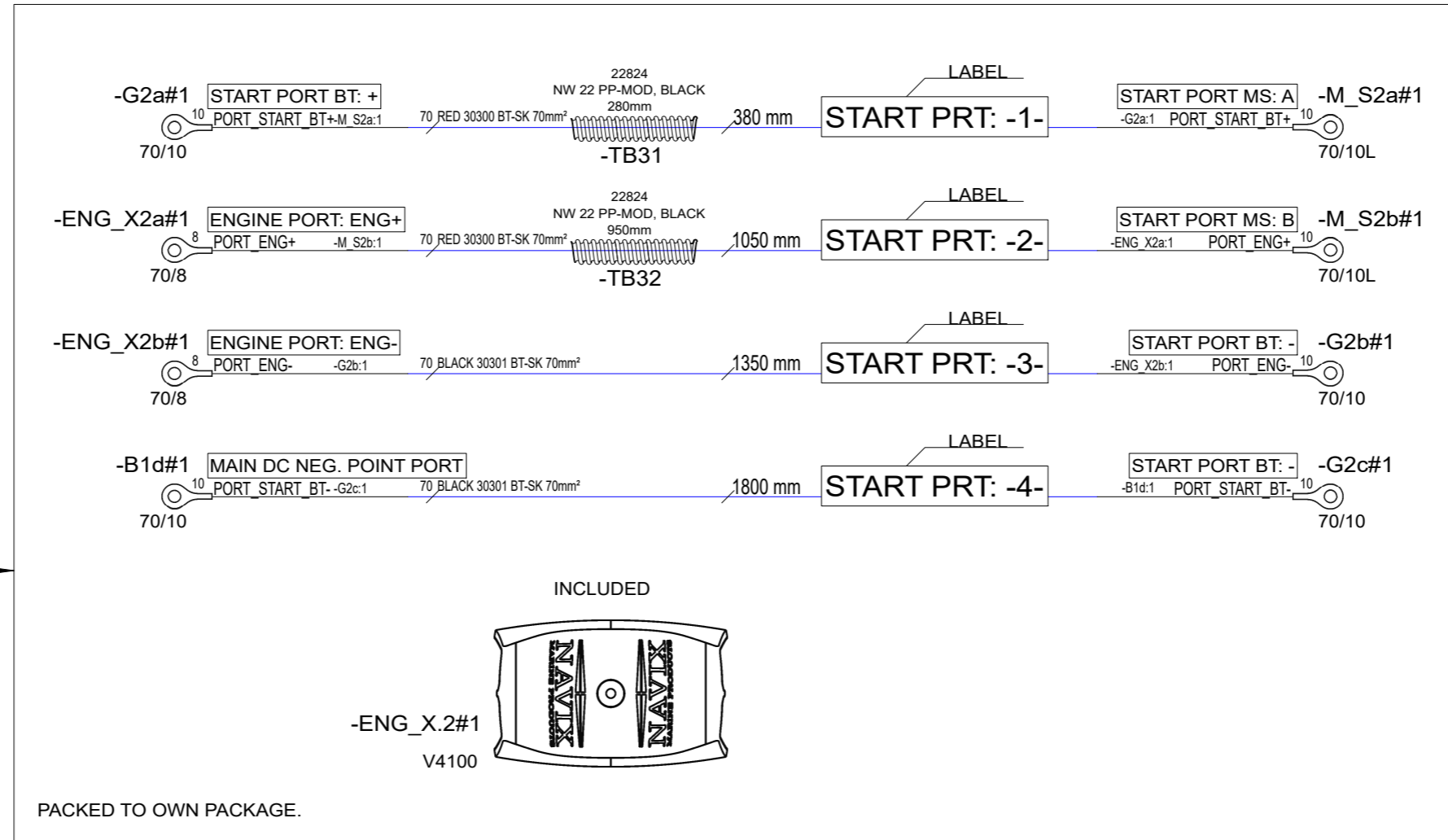
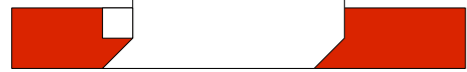

START PRT CABLES

(TO TOP OF PACKAGE)

NOTICE!
BATTERY CABLES NEED TO ADD MARKINGS
SHOWN IN EXAMPLE BELOW.

EXEMPTION:
ALL BLACK WIRES
THIS MARKING IS NOT NEEDED.

EXAMPLE: RED 50mm² WIRE MARKINGS.

MARKING SHOWN ABOVE ONLY TO CABLES LISTED BELOW.

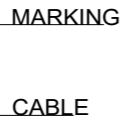

LOOK FOR EQUIVALENT AWG SIZE FOR mm²
AND ADD THIS TO CABLE MARKINGS.

FOR EXAMPLE:
CABLE SIZE IS 70mm² --> MARKING AWG2/0.

EQUIVALENCY:	
mm ²	AWG
25 mm ²	= AWG3
35 mm ²	= AWG2
50 mm ²	= AWG0
70 mm ²	= AWG2/0
95 mm ²	= AWG3/0
120 mm ²	= 250 kcmil

19.4.2024	PF	G5: 2005054; Not modified
22.9.2021	VV	E5: NOT MODIFIED / REVISION RETURNED TO REV. E.
17.2.2023	RK	F5: NOT MODIFIED.
Date of modification	Modified by	Description

Date	5.7.2019
Drawing by	TuM
Sheet rev.	5
Project rev.	G



Axopar	29607	Project ID
Boat	37 MY20	Sub-product code
Boat model	BATTERY BOX CABLES STANDARD	Product code
	HL	143 / 213
	Loc	Sheet

NOTICE! CABLES WITH STICKER

FOR EXAMPLE
HEAVY AMP: POWER+

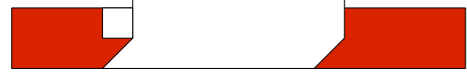

LABEL
POWER STEER CABLES

(TO TOP OF PACKAGE)

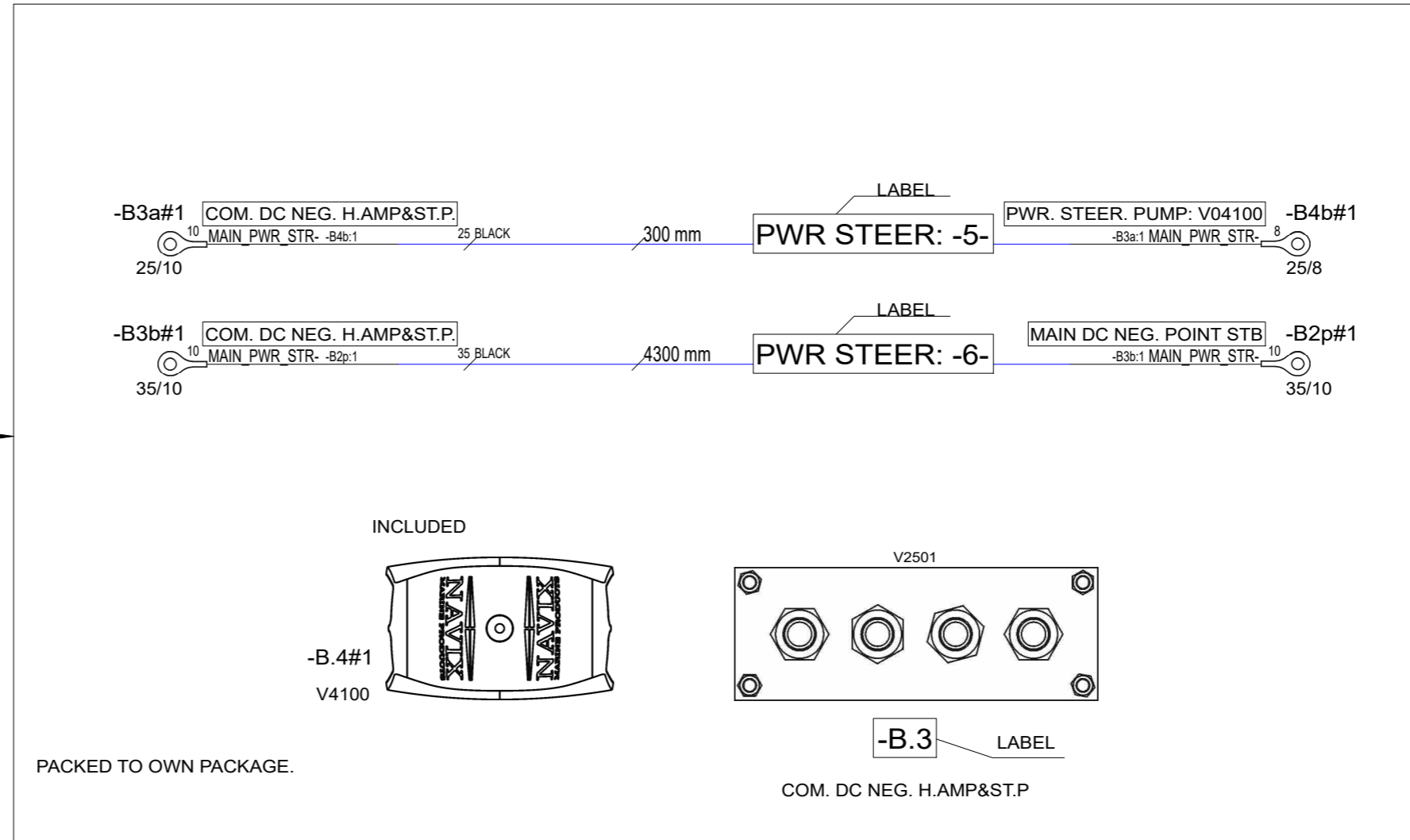

NOTICE!
BATTERY CABLES NEED TO ADD MARKINGS
SHOWN IN EXAMPLE BELOW.

EXEMPTION:
ALL BLACK WIRES
THIS MARKING IS NOT NEEDED.

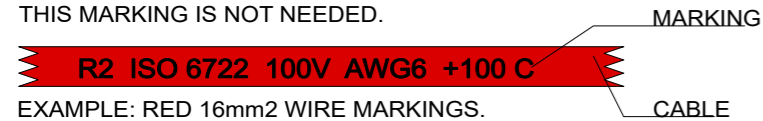

EXAMPLE: RED 16mm² WIRE MARKINGS.

MARKING SHOWN ABOVE ONLY TO CABLES LISTED BELOW.

EQUIVALENCY:

mm ²	AWG
10 mm ²	= AWG8
16 mm ²	= AWG6
25 mm ²	= AWG3
35 mm ²	= AWG2

LOOK FOR EQUIVALENT AWG SIZE FOR mm²
AND ADD THIS TO CABLE MARKINGS.

FOR EXAMPLE:
CABLE SIZE IS 25mm² --> MARKING AWG3.

19.4.2024	PF	G5: 2005054; Not modified	Date	5.7.2019	NAVIX designed solutions	Axopar			
22.9.2021	VV	E5: NOT MODIFIED / REVISION RETURNED TO REV. E.	Drawing by	TuM		Boat	29607		
17.2.2023	RK	F5: NOT MODIFIED.	Sheet rev.	5	37 MY20	Sub-product code	Product code	Project ID	
Date of modification	Modified by	Description	Project rev.	G	Copyright by	Boat model	BATTERY BOX CABLES STANDARD	HL	144 / 213
1	2	3	4	5	6	7	8	9	10

NOTICE! CABLES WITH STICKER

FOR EXAMPLE
HEAVY AMP: POWER+

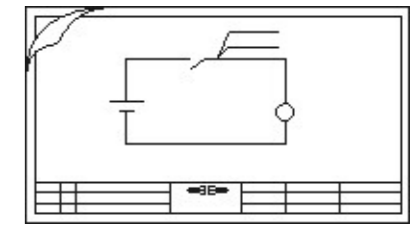

DOCUMENTS INCLUDED:

29611 BATTERY BOX
INVERTER CABLE SET

INVERTER CABLES

(TO TOP OF PACKAGE)

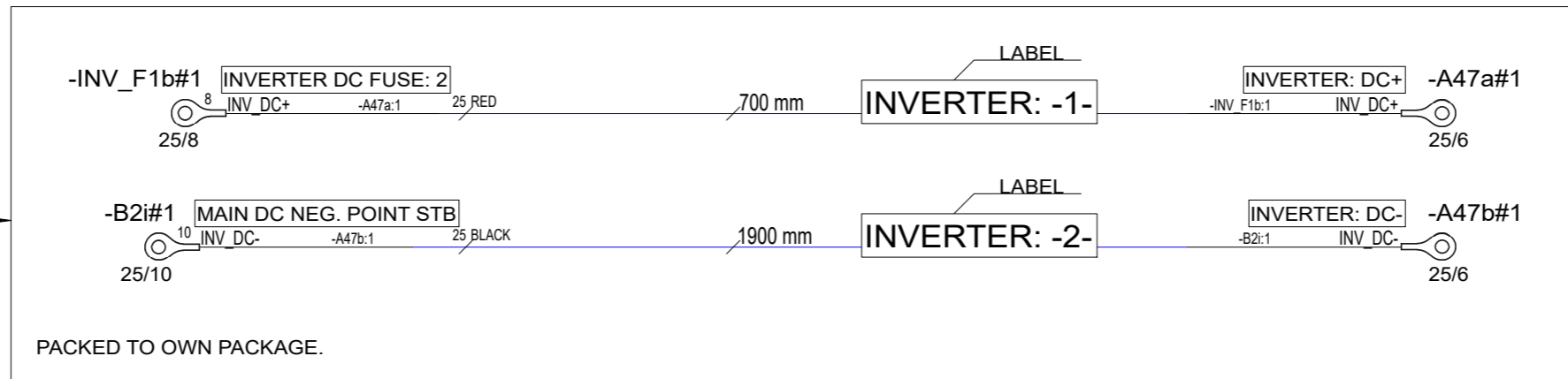

PACKED TO OWN PACKAGE.

NOTICE!
BATTERY CABLES NEED TO ADD MARKINGS
SHOWN IN EXAMPLE BELOW.

EXEMPTION:
ALL BLACK WIRES
THIS MARKING IS NOT NEEDED.

R2 ISO 6722 100V AWG6 +100 C

EXAMPLE: RED 16mm² WIRE MARKINGS.

MARKING SHOWN ABOVE ONLY TO CABLES LISTED BELOW.

EQUIVALENCY:

mm ²	=	AWG
10 mm ²	=	AWG8
16 mm ²	=	AWG6
25 mm ²	=	AWG3
35 mm ²	=	AWG2

LOOK FOR EQUIVALENT AWG SIZE FOR mm²
AND ADD THIS TO CABLE MARKINGS.

FOR EXAMPLE:
CABLE SIZE IS 25mm² --> MARKING AWG3.

19.4.2024	PF	G3: 2005054; Not modified	Date	6.7.2019		Axopar					
22.9.2021	VV	E3: NOT MODIFIED / REVISION RETURNED TO REV. E.	Drawing by	TuM		Boat	37 MY20	Sub-product code	29611	Product code	Project ID
17.2.2023	RK	F3: NOT MODIFIED.	Sheet rev.	3		Boat model		BATTERY BOX		HL	145 / 213
Date of modification	Modified by	Description	Project rev.	G	Copyright by		INVERTER CABLE SET		Loc	Sheet	

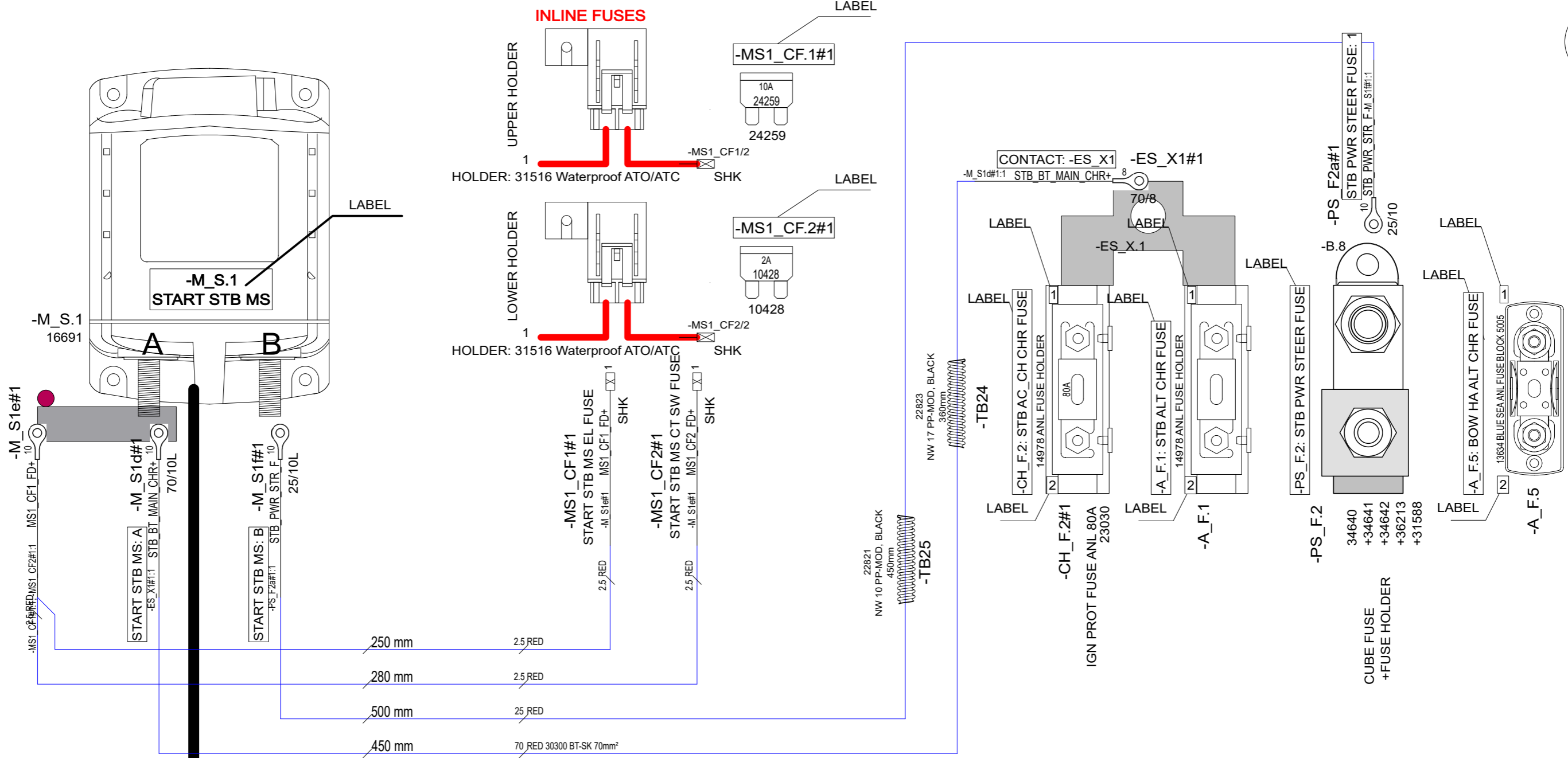

1.

ADD: M10 X 30mm BOLT
M10 WASHER
M10 SPRING WASHER
M10 NUT

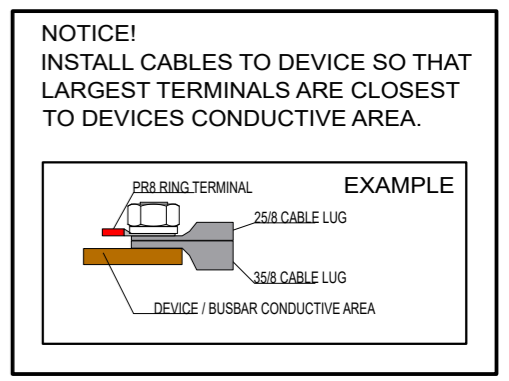
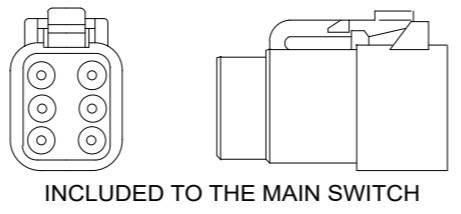
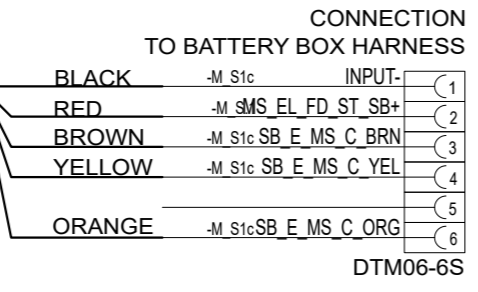
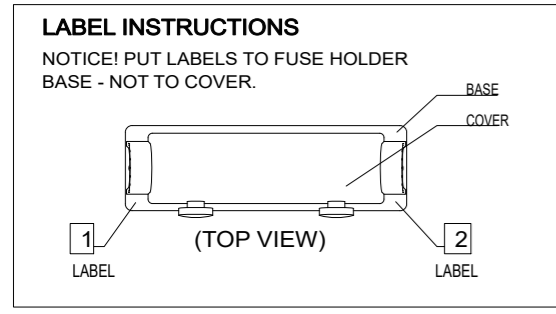

19.4.2024	PF	G11: 2005054; Not modified	Date	2.7.2019	NAVIX designed solutions	Axopar	SEE EXP VIEW	29613	Project ID
17.2.2023	RK	F10: FUSE HOLDERS CHANGED TO 31516.	Drawing by	TuM		Boat	Sub-product code	Product code	
13.10.2023	PF	F11:2004855; A_F.5 holder, A_F.5 ->39903, cable sizes, AW_F.1->125A	Sheet rev.	11	Copyright by	37 MY20	BATTERY BOX	HL	146 / 213
Date of modification	Modified by	Description	Project rev.	G		Boat model	STB PANEL 1	Loc	

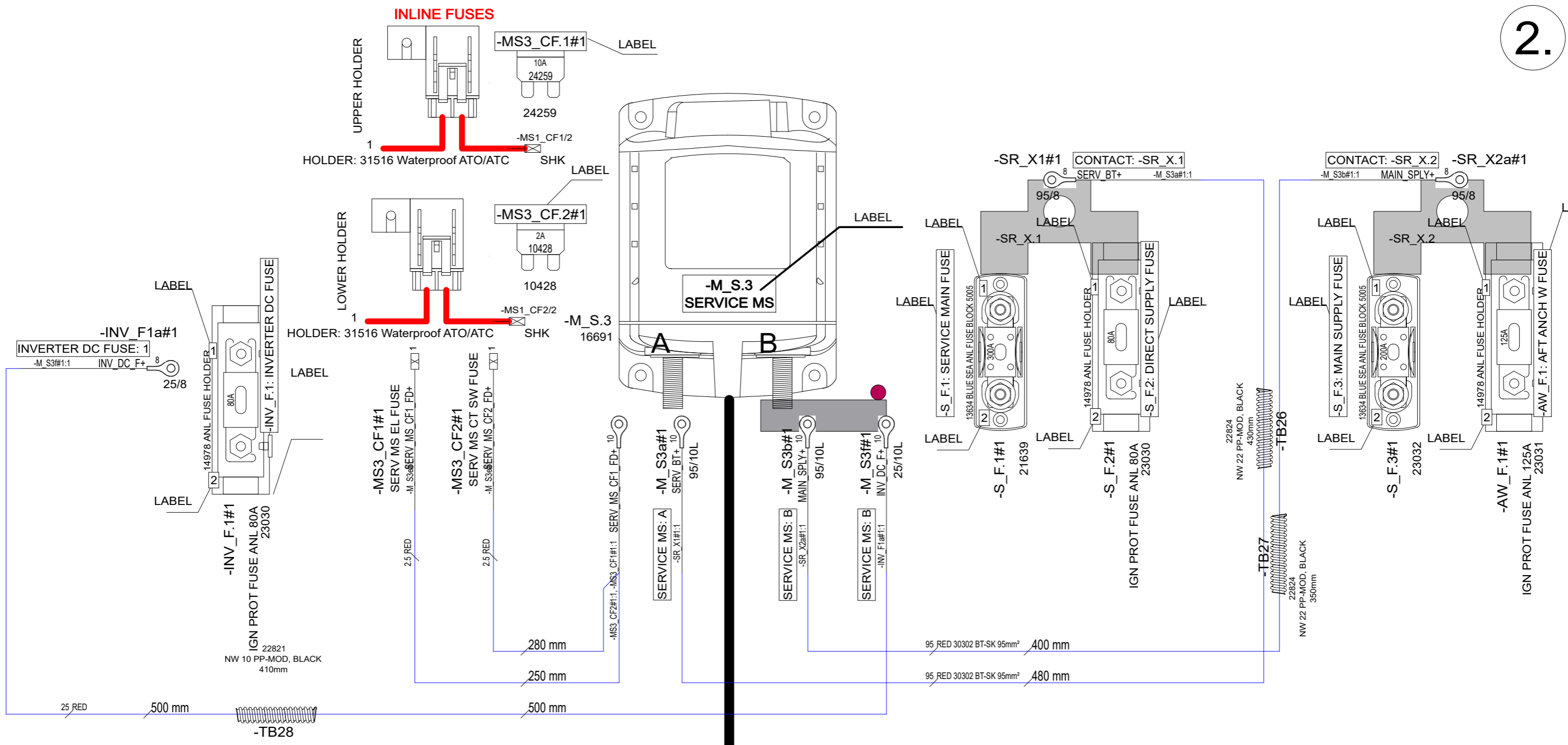

NOTICE!
INSTALL CABLES TO DEVICE SO THAT LARGEST TERMINALS ARE CLOSEST TO DEVICES CONDUCTIVE AREA.

EXAMPLE

LABEL INSTRUCTIONS
NOTICE! PUT LABELS TO FUSE HOLDER BASE - NOT TO COVER.

(TOP VIEW)

● ADD: M10 X 30mm BOLT
M10 WASHER
M10 SPRING WASHER
M10 NUT

CONNECTION TO BATTERY BOX HARNESS

BLACK	-M_S3c INPUT-	1
RED	-M_S3SERV_MS_C_RED	2
BROWN	-M_S3cSERV_MS_C_BRN	3
YELLOW	-M_S3cSERV_MS_C_YEL	4
ORANGE	-M_S3cSERV_MS_C_ORG	5
		6

DTM06-6S

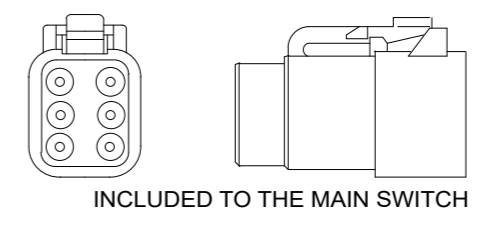

19.4.2024	PF	G11: 2005054; Not modified	Date	3.7.2019	NAVIX designed solutions	Axopar	SEE EXP VIEW	29613	Project ID
17.2.2023	RK	F10: FUSE HOLDERS CHANGED TO 31516.	Drawing by	TuM		Boat	Sub-product code	Product code	
13.10.2023	PF	F11:2004855; A_F.5 holder, A_F.5 ->39903, cable sizes, AW_F.1->125A	Sheet rev.	11	Copyright by	37 MY20	BATTERY BOX	HL	147 / 213
Date of modification	Modified by	Description	Project rev.	G		Boat model	STB PANEL 1	Loc	

GENERAL LAYOUT/ LABELS / CABLE ROUTING

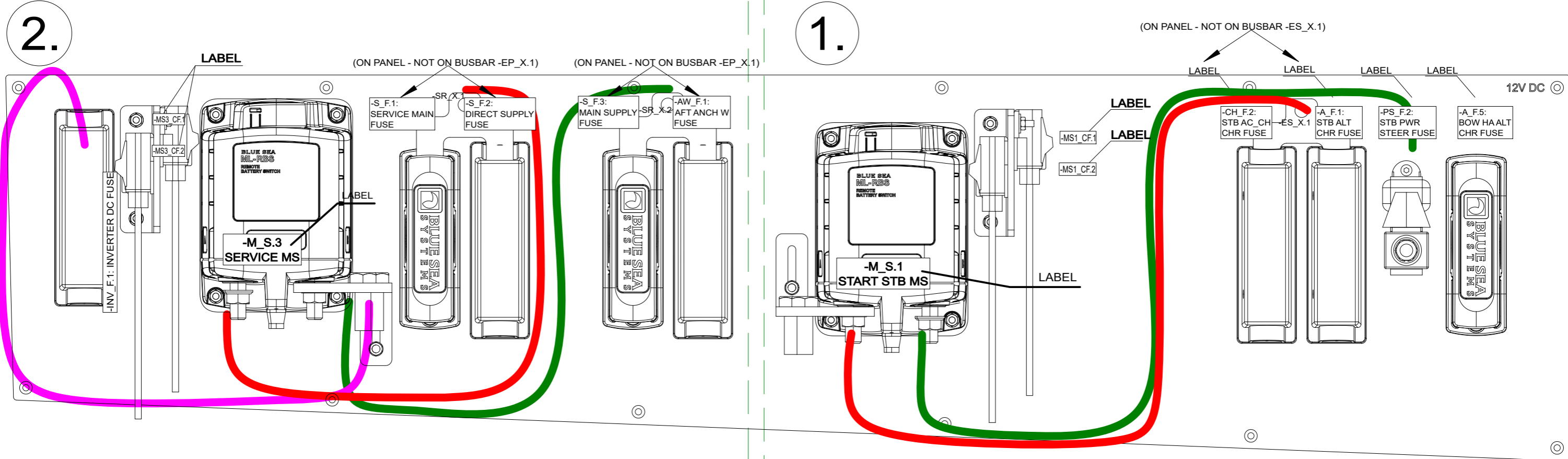

NOTICE!
BATTERY CABLES NEED TO ADD MARKINGS SHOWN IN EXAMPLE BELOW.

EXEMPTION:
ALL BLACK WIRES
THIS MARKING IS NOT NEEDED.



EXAMPLE: RED 50mm² WIRE MARKINGS.

MARKING SHOWN ABOVE ONLY TO CABLES LISTED BELOW.

	EQUIVALENCY:	
	mm ²	AWG
LOOK FOR EQUIVALENT AWG SIZE FOR mm ² AND ADD THIS TO CABLE MARKINGS.	25 mm ²	= AWG3
	35 mm ²	= AWG2
	50 mm ²	= AWG0
	70 mm ²	= AWG2/0
FOR EXAMPLE: CABLE SIZE IS 70mm ² --> MARKING AWG2/0.	95 mm ²	= AWG3/0
	120 mm ²	= 250 kcmil

NOTICE!
VERIFY THAT ALL CABLES HAVE MARKINGS SHOWN IN EXAMPLE BELOW.

EXEMPTION:
ALL <500mm WIRES, BLACK WIRES AND HI-FLEX CABLES
THIS MARKING IS NOT NEEDED.

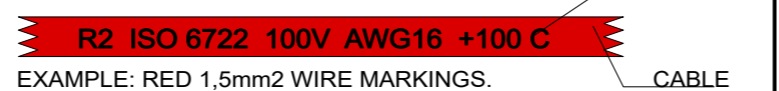

EXAMPLE: RED 1,5mm² WIRE MARKINGS.

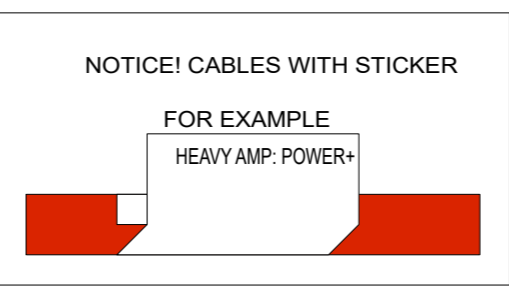

19.4.2024	PF	G11: 2005054; Not modified	Date	3.7.2019
17.2.2023	RK	F10: FUSE HOLDERS CHANGED TO 31516.	Drawing by	TuM
13.10.2023	PF	F11:2004855; A_F.5 holder, A_F.5 ->39903, cable sizes, AW_F.1->125A	Sheet rev.	11
Date of modification	Modified by	Description	Project rev.	G



Axopar	SEE EXP VIEW	29613	Project ID
Boat	Sub-product code	Product code	
37 MY20	BATTERY BOX	HL	148 / 213
Boat model	STB PANEL 1	Loc	

EXP VIEW

29613_AXOPAR_37_MY20_BATTERY_BOX_STB_PANEL_1

BRACKET FOR 31516 FUSEHOLDER

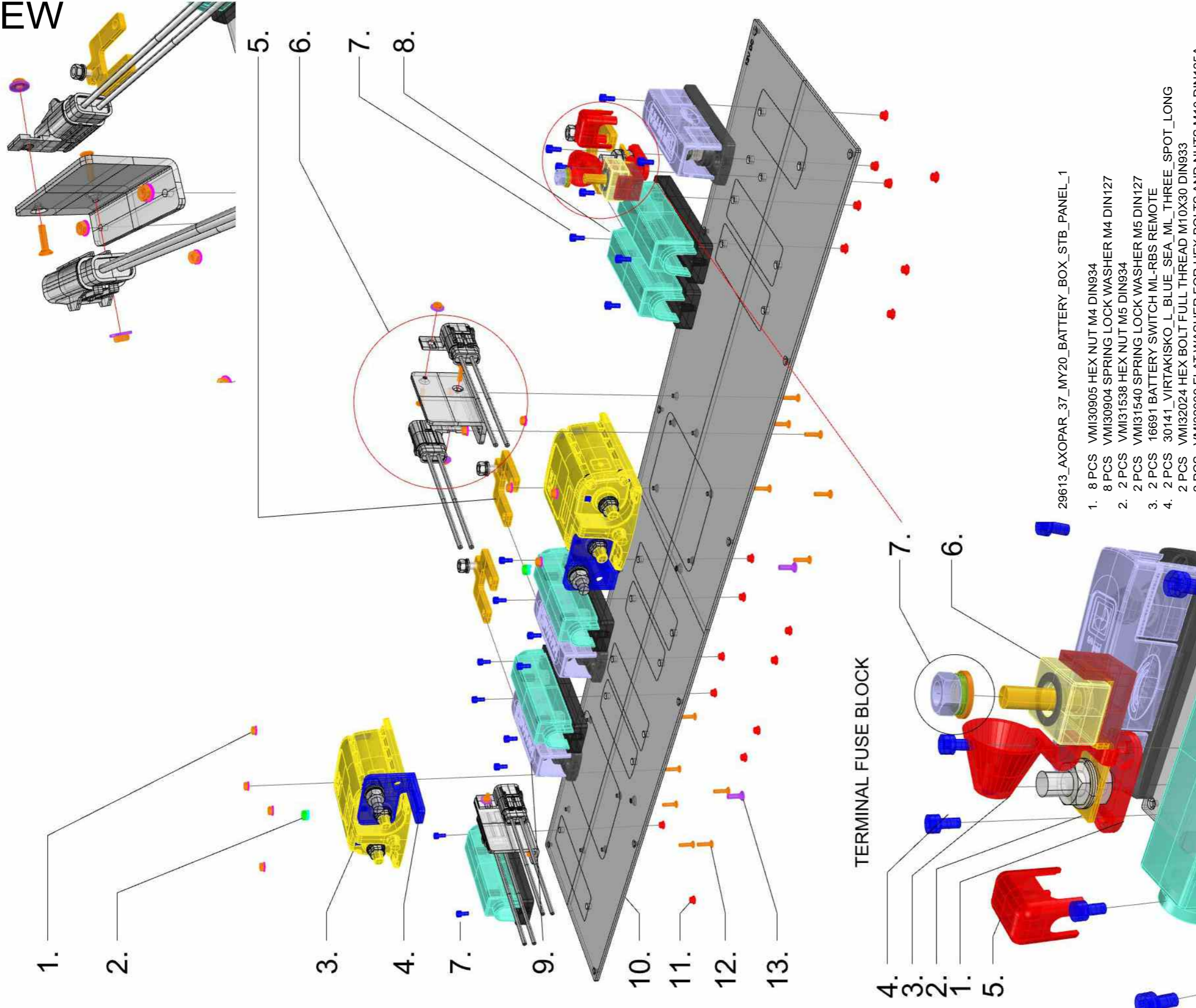

29613_AXOPAR_37_MY20_BATTERY_BOX_STB_PANEL_1

- 1. 8 PCS VMI30905 HEX NUT M4 DIN934
- 8 PCS VMI30904 SPRING LOCK WASHER M4 DIN127
- 2. 2 PCS VMI31538 HEX NUT M5 DIN934
- 2 PCS VMI31540 SPRING LOCK WASHER M5 DIN127
- 3. 2 PCS 16691 BATTERY SWITCH ML-RBS REMOTE
- 4. 2 PCS 30141_VIRTAKISKO_L_BLUE_SEA_ML_THREE_SPOT_LONG
- 2 PCS VMI32024 HEX BOLT FULL THREAD M10X30 DIN933
- 2 PCS VMI32009 FLAT WASHER FOR HEX BOLTS AND NUTS M10 DIN125A
- 2 PCS VMI32008 SPRING LOCK WASHER M10 DIN127
- 2 PCS VMI32010 HEX NUT M10 DIN934
- 5. 3 PCS 30142_ANL_CONNECTION_BAR_DOUBLE
- 3 PCS VMI32018 HEX BOLT FULL THREAD M8X25 DIN933
- 3 PCS VMI32013 FLAT WASHER FOR HEX BOLTS AND NUTS M8 DIN125A
- 3 PCS VMI32011 SPRING LOCK WASHER M8 DIN127
- 3 PCS VMI32012 HEX NUT M8 DIN934
- 6. 4 PCS 31516 Fuseholder waterproofATO ATC 5065B-BSS (as in diagram)
- 2 PC 38604_NAVIX_LINE_BRACKET_FOR_31516_FUSEHOLDER_(WOC)
- 8 PC VMI30906 Flat Washer for HEX bolts and nuts M4 DIN125A
- 8 PC VMI30905 HEX NUT M4 DIN934
- 4 PC VMI30917 COUNTERSUNK HEAD SCREW HEX SOCKET M4X16 DIN7991
- 7. 16 PCS VMI30942 HEX SOCKET HEAD CAP SCREW M4X8 DIN912
- 8. 5 PCS 14978_ANL_FUSE HOLDER
- 9. 3 PCS 13634 Blue Sea ANL FUSE BLOCK 5005 35A to 300A (as in diagram)
- 10. 1 PC 29896_AXOPAR_37_MY20_BATTERY_BOX_STB_PANEL_1_(WOC)_V7
- 11. 18 PCS 9872 PURISTEVÄLHOLKKI ETSOS M4X4
- 12. 12 PCS VMI30917 COUNTERSUNK HEAD SCREW HEX SOCKET M4X16 DIN7991
- 13. 2 PCS VMI31796 COUNTERSUNK HEAD SCREW HEX SOCKET M5X16 DIN7991

TERMINAL FUSE BLOCK

- TERMINAL FUSE BLOCK - as in diagram
- 1. 1pc 36213 POWER DISTRIBUTION STUD (S-10mm-1R)
 - 2. 1pc 34642 CFBAR1-250SP SINGLE STUD
 - 3. 1pc 34641-B.6 CFCOVER-1R SINGLE STUD/RED
 - 4. 2pcs VMI30942 HEX SOCKET HEAD CAP SCREW M4X8 DIN912
 - 5. 1pc 31588 INSULATED COVER POSITIVE RED ISC-10R
 - 6. 1pc 34640-PS_F.6 CUBE FUSE MRFB-080 80A
 - 7. 1pc VMI36860 HEX NUT 1/4" UNF A4
 - 1pc VMI31830 SPRING LOCK WASHER M6 DIN127
 - 1pc VMI31831 FLAT WASHER FOR HEX BOLTS AND NUTS M6 DIN125A
 - 1pc VMI36859 FLAT WIDE WASHER FOR HEX BOLTS AND NUTS M6

TE 28.06.-19
TE 30.09.-19
MN 23.01.-20
TE 17.04.-20
TE 02.12.-21
TE 14.03.-23
MN 27.9.2023 (Project 2004855)

19.4.2024	PF	G11: 2005054; Not modified	Date	3.7.2019
17.2.2023	RK	F10: FUSE HOLDERS CHANGED TO 31516.	Drawing by	TuM
13.10.2023	PF	F11:2004855; A_F.5 holder, A_F.5 ->39903, cable sizes, AW_F.1->125A	Sheet rev.	11
Date of modification	Modified by	Description	Project rev.	G



Axopar
Boat
37 MY20
Boat model

SEE EXP VIEW	29613	Project ID
Sub-product code	Product code	
BATTERY BOX	HL	149 / 213
STB PANEL 1	Loc	

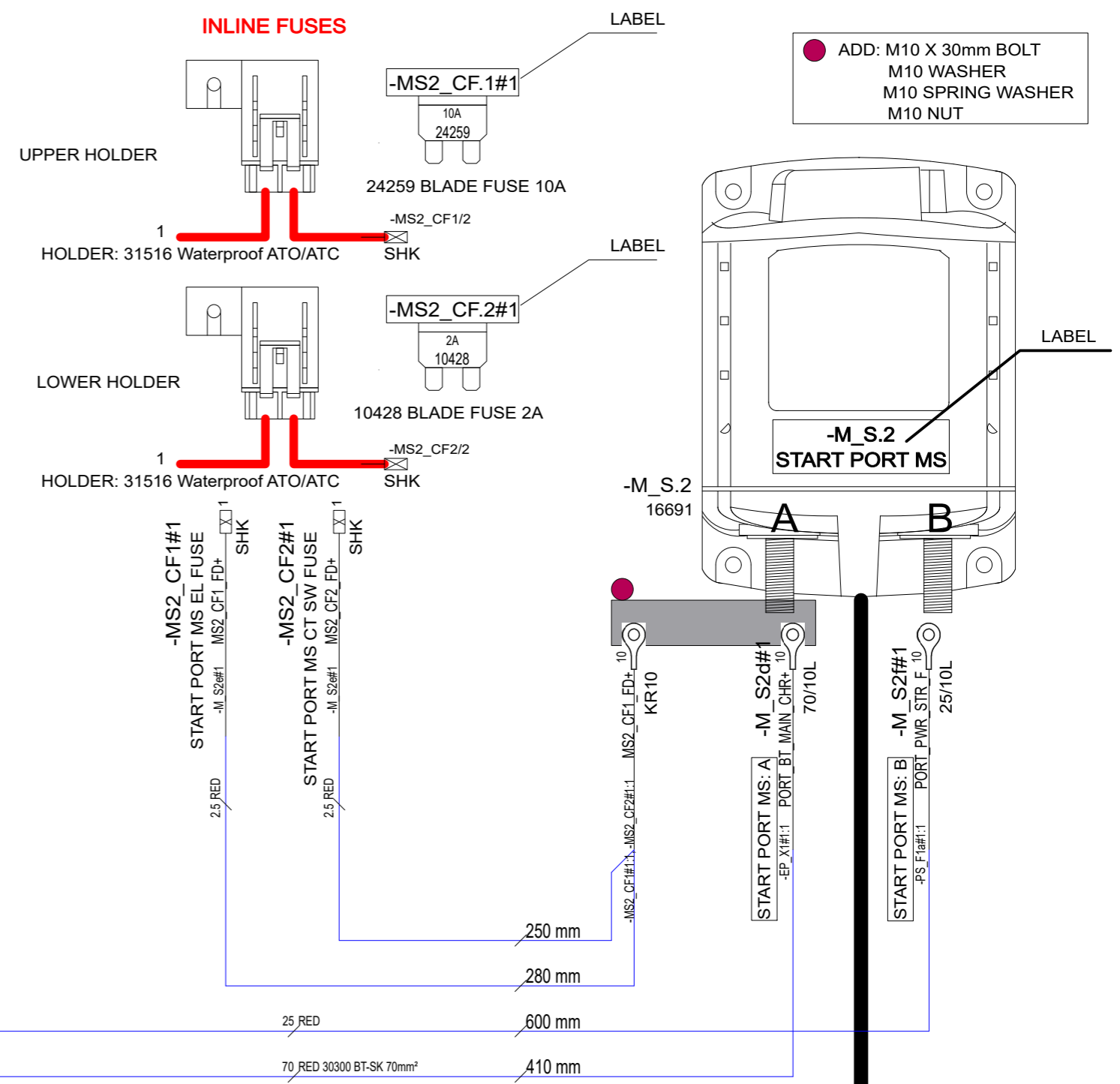
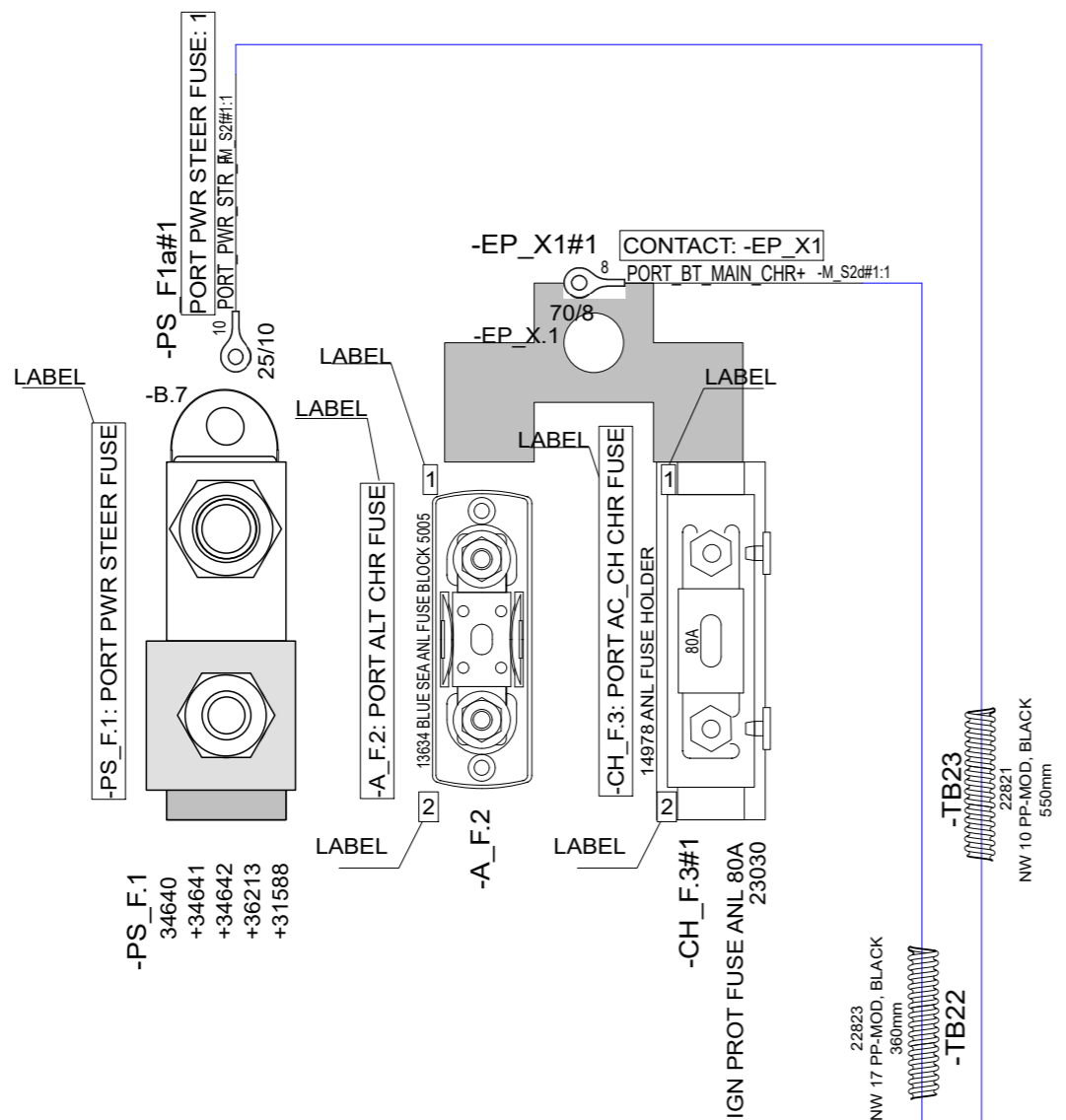

● ADD: M10 X 30mm BOLT
M10 WASHER
M10 SPRING WASHER
M10 NUT

NOTICE!
INSTALL CABLES TO DEVICE SO THAT LARGEST TERMINALS ARE CLOSEST TO DEVICES CONDUCTIVE AREA.

EXAMPLE

LABEL INSTRUCTIONS
NOTICE! PUT LABELS TO FUSE HOLDER BASE - NOT TO COVER.

(TOP VIEW)

CONNECTION TO BATTERY BOX HARNESS

1	INPUT-	-M S2c	BLACK
2	PT E MS C RED	-M S.2	RED
3	PT E MS C BRN	-M S2c	BROWN
4	PT E MS C YEL	-M S2c	YELLOW
5			
6	PT E MS C ORG	-M S2c	ORANGE

DTM06-6S

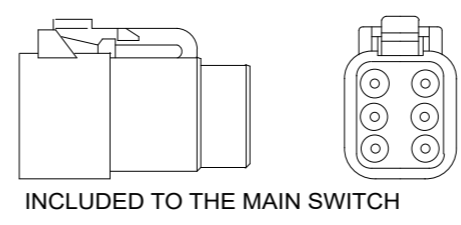

17.2.2023	RK	F8: FUSE HOLDERS CHANGED TO 31516.	Date	1.7.2019
13.10.2023	PF	F9: 2004855; A_F.2 holder -> Bluesea, fuse moved to 39902, cable sizes	Drawing by	TuM
11.4.2024	PF	G10: 2005054; Bow ch fuse removed	Sheet rev.	10
Date of modification	Modified by	Description	Project rev.	G



Axopar	SEE EXP VIEW	29615	Project ID
Boat	Sub-product code	Product code	
37 MY20	BATTERY BOX PORT PANEL 1	HL	150 / 213
Boat model	Title	Loc	

GENERAL LAYOUT/ LABELS/ CABLE ROUTINGS

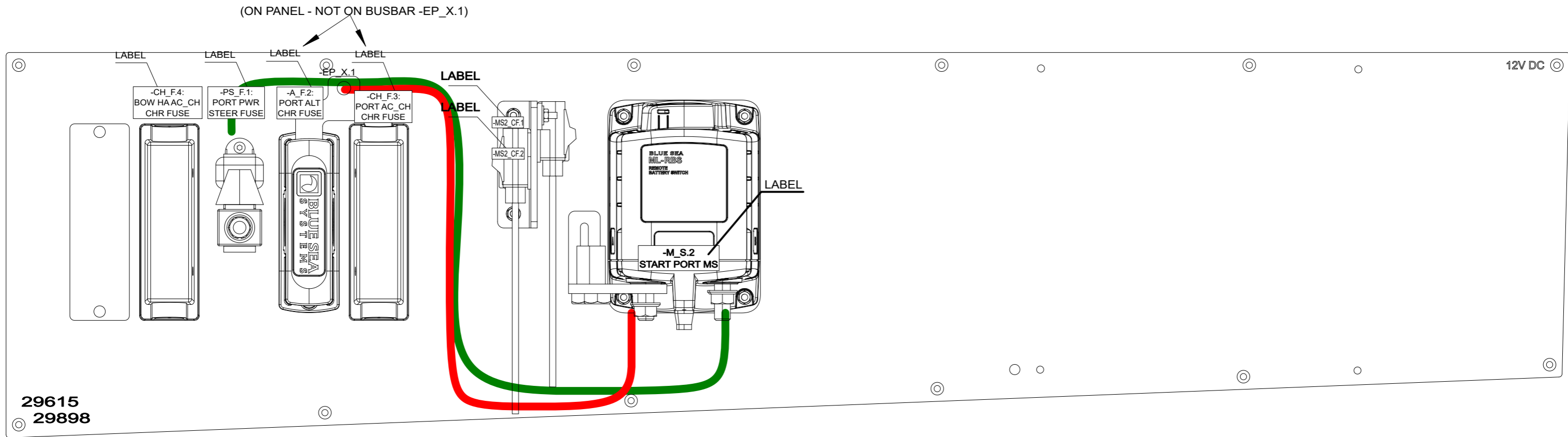

29615
29898

NOTICE!
BATTERY CABLES NEED TO ADD MARKINGS SHOWN IN EXAMPLE BELOW.

EXEMPTION:
ALL BLACK WIRES
THIS MARKING IS NOT NEEDED.

EXAMPLE: RED 50mm² WIRE MARKINGS.

MARKING SHOWN ABOVE ONLY TO CABLES LISTED BELOW.

EQUIVALENCY:	
mm ²	AWG
25 mm ²	= AWG3
35 mm ²	= AWG2
50 mm ²	= AWG0
70 mm ²	= AWG2/0
95 mm ²	= AWG3/0
120 mm ²	= 250 kcmil

LOOK FOR EQUIVALENT AWG SIZE FOR mm² AND ADD THIS TO CABLE MARKINGS.

FOR EXAMPLE:
CABLE SIZE IS 70mm² --> MARKING AWG2/0.

NOTICE!
VERIFY THAT ALL CABLES HAVE MARKINGS SHOWN IN EXAMPLE BELOW.

EXEMPTION:
ALL <500mm WIRES, BLACK WIRES AND HI-FLEX CABLES
THIS MARKING IS NOT NEEDED.

EXAMPLE: RED 1,5mm² WIRE MARKINGS.

NOTICE! CABLES WITH STICKER

FOR EXAMPLE

HEAVY AMP: POWER+

17.2.2023	RK	F8: FUSE HOLDERS CHANGED TO 31516.	Date	1.7.2019		Axopar	SEE EXP VIEW	29615	Project ID 151/ 213 Sheet	
13.10.2023	PF	F9: 2004855; A_F.2 holder -> Bluesea, fuse moved to 39902, cable sizes	Drawing by	TuM		Boat	Sub-product code	Product code		HL
11.4.2024	PF	G10: 2005054; Bow ch fuse removed	Sheet rev.	10		37 MY20	BATTERY BOX	Loc		
Date of modification	Modified by	Description	Project rev.	G	Boat model	Title				

29615_AXOPAR_37_MY20_BATTERY_BOX_PORT_PANEL_1

EXP VIEW

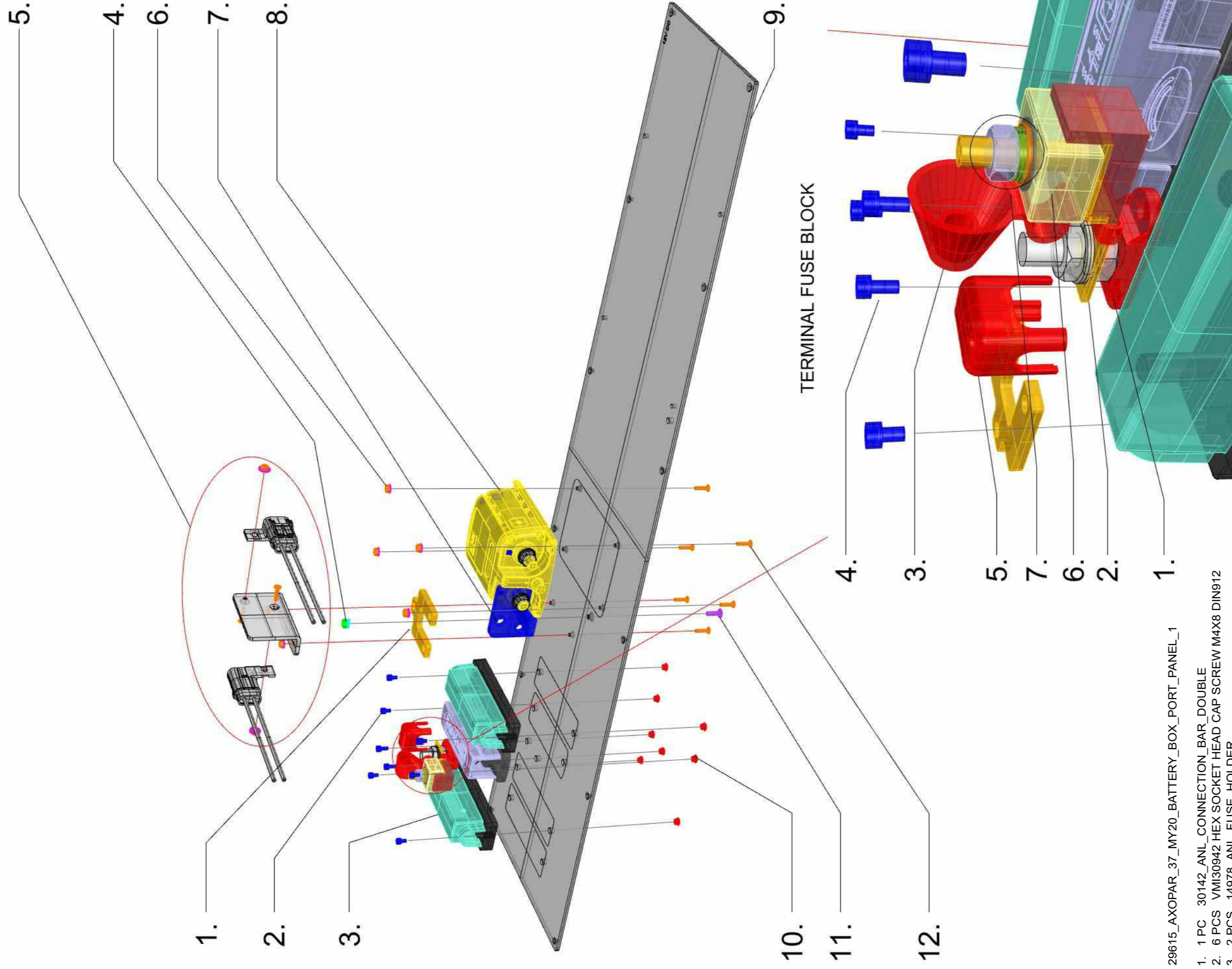

29615_AXOPAR_37_MY20_BATTERY_BOX_PORT_PANEL_1

- 1. 1 PC 30142_ANL_CONNECTION_BAR_DOUBLE
- 2. 6 PCS VMI30942 HEX SOCKET HEAD CAP SCREW M4X8 DIN912
- 3. 2 PCS 14978_ANL_FUSE HOLDER
- 1 PC 13634 Blue Sea ANL FUSE BLOCK 5005 35A to 300A
- 4. 1 PC VMI31538 HEX NUT M5 DIN934
- 1 PC VMI31540 SPRING LOCK WASHER M5 DIN127
- 2 PCS 31516_Fuseholder waterproof/ATO ATC 5065B-BSS (as in diagram)
- 1 PC 38604_NAVIX_LINE_BRACKET_FOR_31516_FUSEHOLDER_(WOC)
- 2 PC VMI30906 Flat Washer for HEX bolts and nuts M4 DIN125A
- 2 PC VMI30904 SPRING LOCK WASHER M4 DIN127
- 4 PC VMI30905 HEX NUT M4 DIN934
- 2 PC VMI30917 COUNTERSUNK HEAD SCREW HEX SOCKET M4X16 DIN7991

- 6. 4 PCS VMI30905 HEX NUT M4 DIN934
- 4 PCS VMI30904 SPRING LOCK WASHER M4 DIN127
- 7. 1 PC 30141_VIRTAKISKO_L_BLUE_SEA_ML_THREE_SPOT_LONG
- 8. 1 PC 16691 BATTERY SWITCH ML-RBS REMOTE
- 9. 1 PC 29898_AXOPAR_37_MY20_BATTERY_BOX_PORT_PANEL_1_(WOC_V7
- 10. 8 PCS 9872_PURISTEVALIHOLKKI ETSOS M4X4
- 11. 1 PC VMI31796 COUNTERSUNK HEAD SCREW HEX SOCKET M5X16 DIN7991
- 12. 6 PCS VMI30917 COUNTERSUNK HEAD SCREW HEX SOCKET M4X16 DIN7991

TERMINAL FUSE BLOCK

- TERMINAL FUSE BLOCK - as in diagram
- 1. 1pc 36213 POWER DISTRIBUTION STUD IS-10mm-1R
 - 2. 1pc 34642 CFBAR1-250SP SINGLE STUD
 - 3. 1pc 34641 -B.6 CFCOVER-1R SINGLE STUD/RED
 - 4. 2pcs VMI30942 HEX SOCKET HEAD CAP SCREW M4X8 DIN912
 - 5. 1pc 31588 INSULATED COVER POSITIVE RED ISC-10R
 - 6. 1pc 34640 -PS_F.6 CUBE FUSE MRFB-080 80A
 - 7. 1pc VMI36860 HEX NUT 1/4" "UNC-A4
 - 1pc VMI31830 SPRING LOCK WASHER M6 DIN127
 - 1pc VMI31831 FLAT WASHER FOR HEX BOLTS AND NUTS M6 DIN125A
 - 1pc VMI36859 FLAT WIDE WASHER FOR HEX BOLTS AND NUTS M6

TE 28.06.-19
 TE 11.10.-19
 TE 17.04.-20
 MN 09.09.-20
 TE 02.12.-21
 TE 14.03.-23
 MN 27.9.2023 (Project 2004855)

17.2.2023	RK	F8: FUSE HOLDERS CHANGED TO 31516.	Date	1.7.2019
13.10.2023	PF	F9: 2004855; A_F.2 holder -> Bluesea, fuse moved to 39902, cable sizes	Drawing by	TuM
11.4.2024	PF	G10: 2005054; Bow ch fuse removed	Sheet rev.	10
Date of modification	Modified by	Description	Project rev.	G



Axopar
Boat
37 MY20
Boat model

SEE EXP VIEW	29615	Project ID
Sub-product code	Product code	
BATTERY BOX	HL	152 / 213
PORT PANEL 1	Loc	
Title		Sheet

-D.2
 38906
 Battery Isolator 180A
 1 input- 2 outputs
 WHISPER WBI 180-
 IG 2 OUTPUTS
 H. AUX 180A MOSFET 1-2

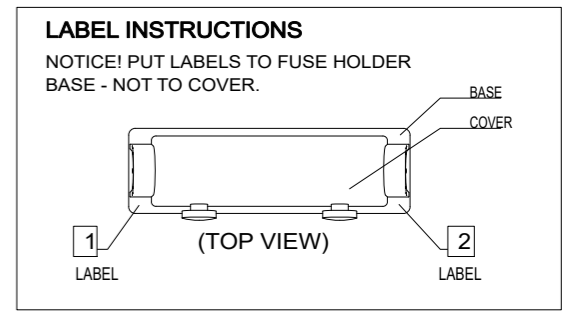
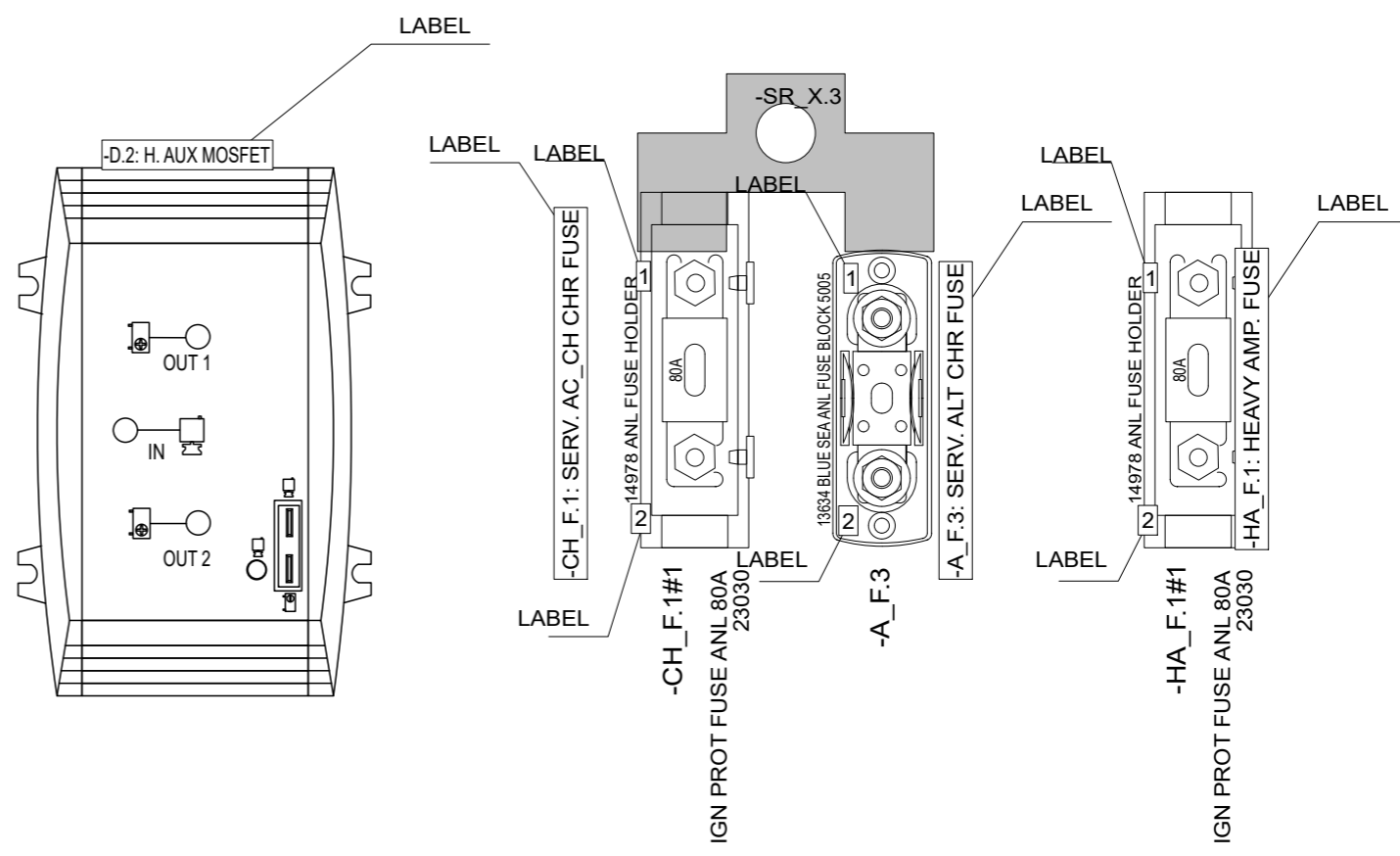

13.10.2023	PF	F5: 2004855; A_F.3 holder -> Blusea, fuse moved to 39902, D.2	Date	1.7.2019
15.4.2024	PF	G6: 2005054; Updated panel, attachment for stern thruster equipment	Drawing by	TuM
17.2.2023	RK	F4: NOT MODIFIED.	Sheet rev.	6
Date of modification	Modified by	Description	Project rev.	G

NAVIX
 designed solutions
 Copyright by

Axopar
 Boat
 37 MY20
 Boat model

SEE EXP VIEW	29617	Project ID
Sub-product code	Product code	
BATTERY BOX FWD WALL PANEL	HL	153 / 213 Sheet
	Loc	

GENERAL LAYOUT/ LABELS

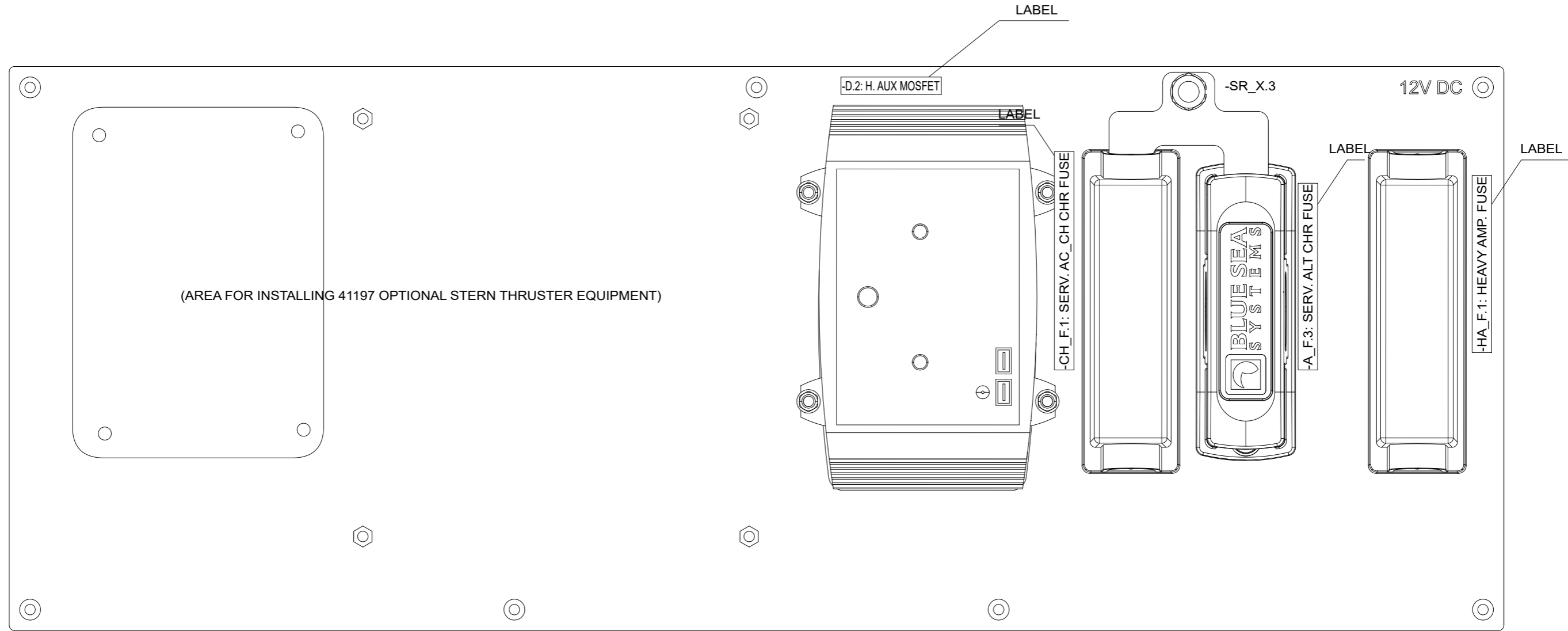

13.10.2023	PF	F5: 2004855; A_F.3 holder -> Blueseas, fuse moved to 39902, D.2	Date	1.7.2019	 NAVIX designed solutions	Axopar	SEE EXP VIEW	29617	Project ID
15.4.2024	PF	G6: 2005054; Updated panel, attachment for stern thruster equipment	Drawing by	TuM		Boat	Sub-product code	Product code	
17.2.2023	RK	F4: NOT MODIFIED.	Sheet rev.	6	37 MY20	BATTERY BOX	FWD WALL PANEL	Loc	154 / 213
Date of modification	Modified by	Description	Project rev.	G	Boat model	Title			Sheet

29617_AXOPAR_37_MY20_BATTERY_BOX_FWD_WALL_PANEL

EXP VIEW

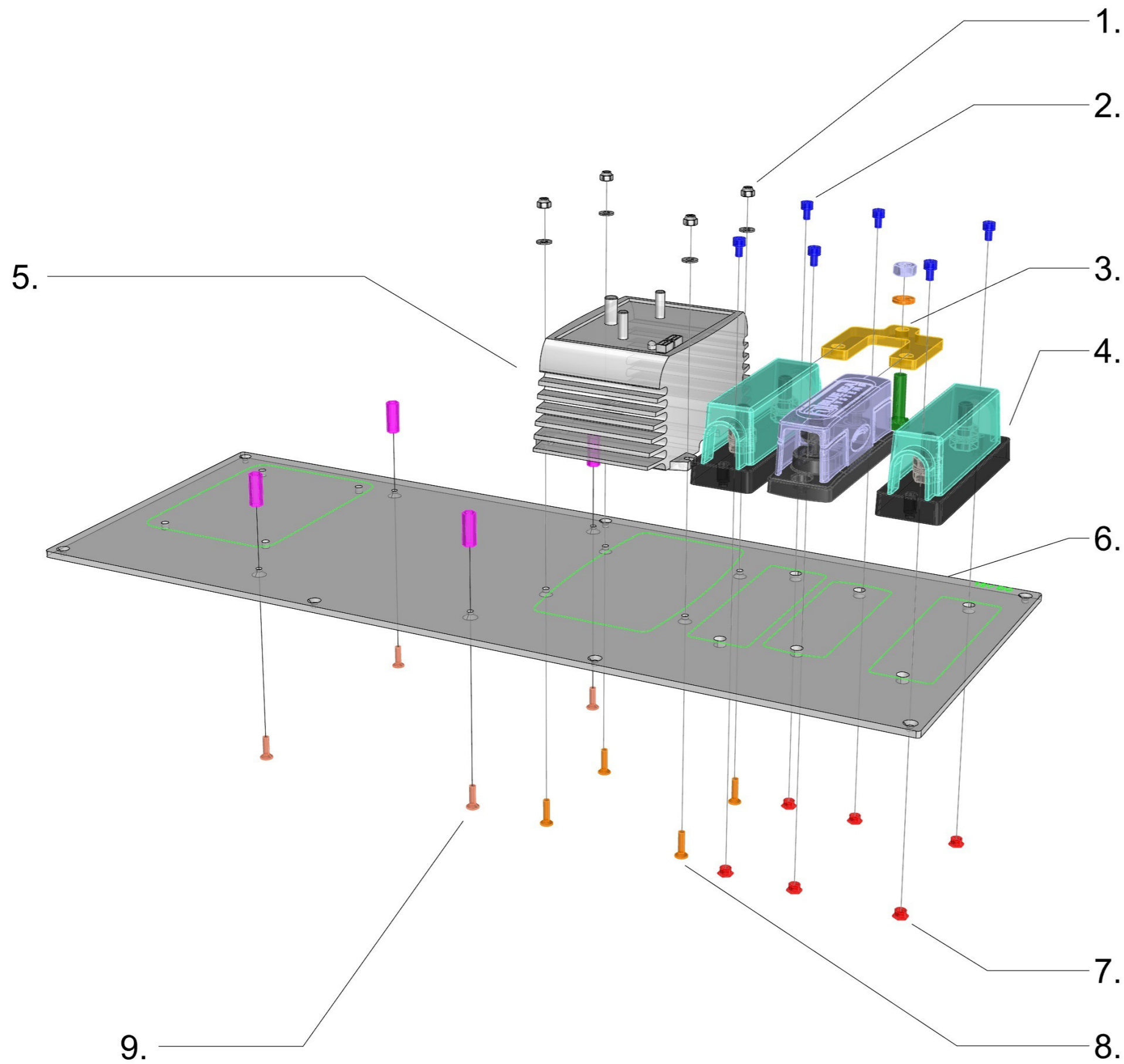

29617_AXOPAR_37_MY20_BATTERY_BOX_FWD_WALL_PANE
L

- 1. 4 PCS VMI30818 SELF-LOCKING HEXAGON NUT M4 DIN985
4 PCS VMI30906 FLAT WASHER FOR HEX BOLTS AND NUTS M4 DIN125A
- 2. 6 PCS VMI30942 - HEX socket Head Cap Screw M4X8 DIN912 C4
- 3. 1 PC 30142_ANL_CONNECTION_BAR_DOUBLE
1 PC VMI32019 - HEX Bolt Full thread M8X30 DIN933 C4
1 PC VMI32011 - Spring Lock washer M8 DIN127 C4
1 PC VMI32012 - HEX Nut M8 DIN934 C4
- 4. 2 PCS 14978_ANL_FUSE HOLDER (AS IN DIAGRAM)
1 PC 13634 Blue Sea ANL FUSE BLOCK 5005 35A to 300A (AS IN DIAGRAM)
- 5. 1 PC 38906 BATTERY ISOLATOR (AS IN DIAGRAM)
- 6. 1 PC
29900_AXOPAR_37_MY20_BATTERY_BOX_FWD_WALL_PANE L_(WOC)_V6
- 7. 6 PCS 9872 - PURISTEVÄLIHOLKKI ETSOS-M4x4 - 50072
- 8. 4 PCS VMI30917 - Countersunk head Screw HEX socket M4X16 DIN7991 C4
- 9. 4 PCS VMI32036 - Extension Bolt M4 L-20
4 PCS VMI30916 - Countersunk head Screw HEX socket M4X14 DIN7991 C4

TE 28.06.2019
MN 23.01.2020
TE 16.04.2020
MN 27.9.2023 (Project 2004855)
TS 18.4.2024 (Project 2005054)

13.10.2023	PF	F5: 2004855; A_F.3 holder -> Blueseas, fuse moved to 39902, D.2	Date	1.7.2019
15.4.2024	PF	G6: 2005054; Updated panel, attachment for stern thruster equipment	Drawing by	TuM
17.2.2023	RK	F4: NOT MODIFIED.	Sheet rev.	6
Date of modification	Modified by	Description	Project rev.	G



Axopar	SEE EXP VIEW	29617	Project ID
Boat	Sub-product code	Product code	
37 MY20	BATTERY BOX	HL	155 / 213
Boat model	FWD WALL PANEL	Loc	

-D.4
38826
BatteryMate 2503 IG
Isolator 3-output 200A

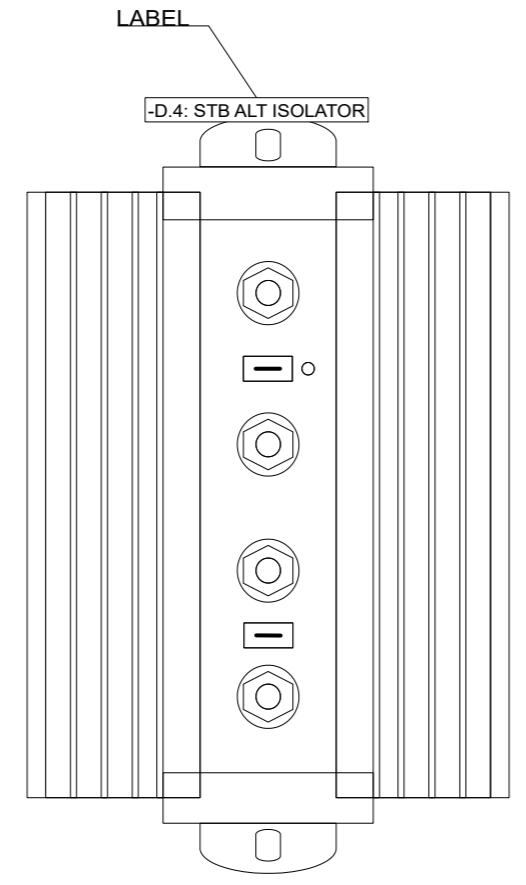

-D.3
23655
Battery Combiner 80A, 2 batteries
Victron BCD 802

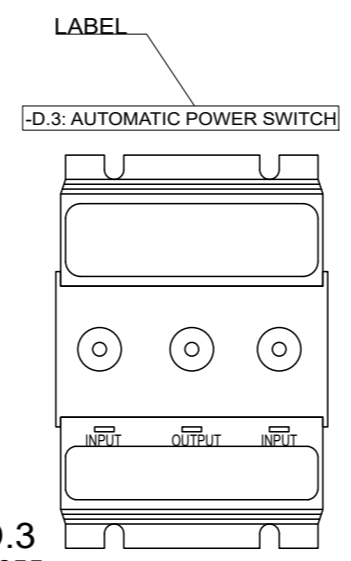

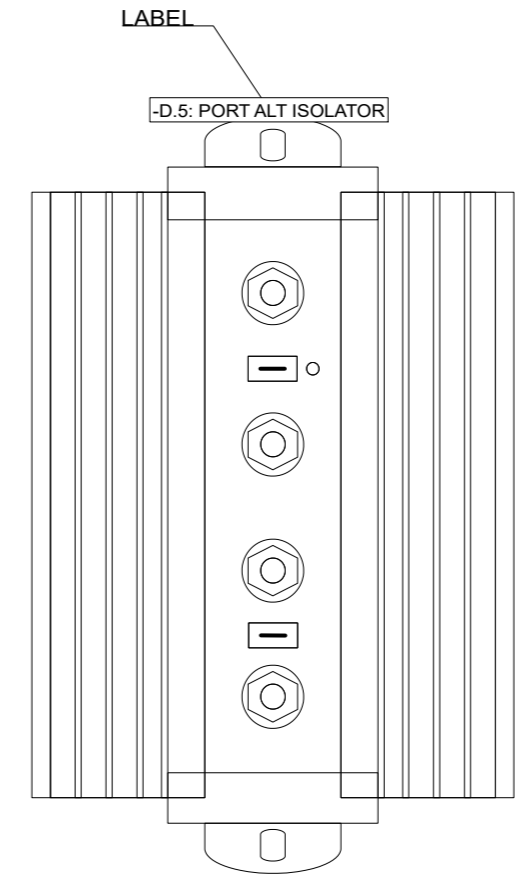

-D.5
38826
BatteryMate 2503 IG
Isolator 3-output 200A

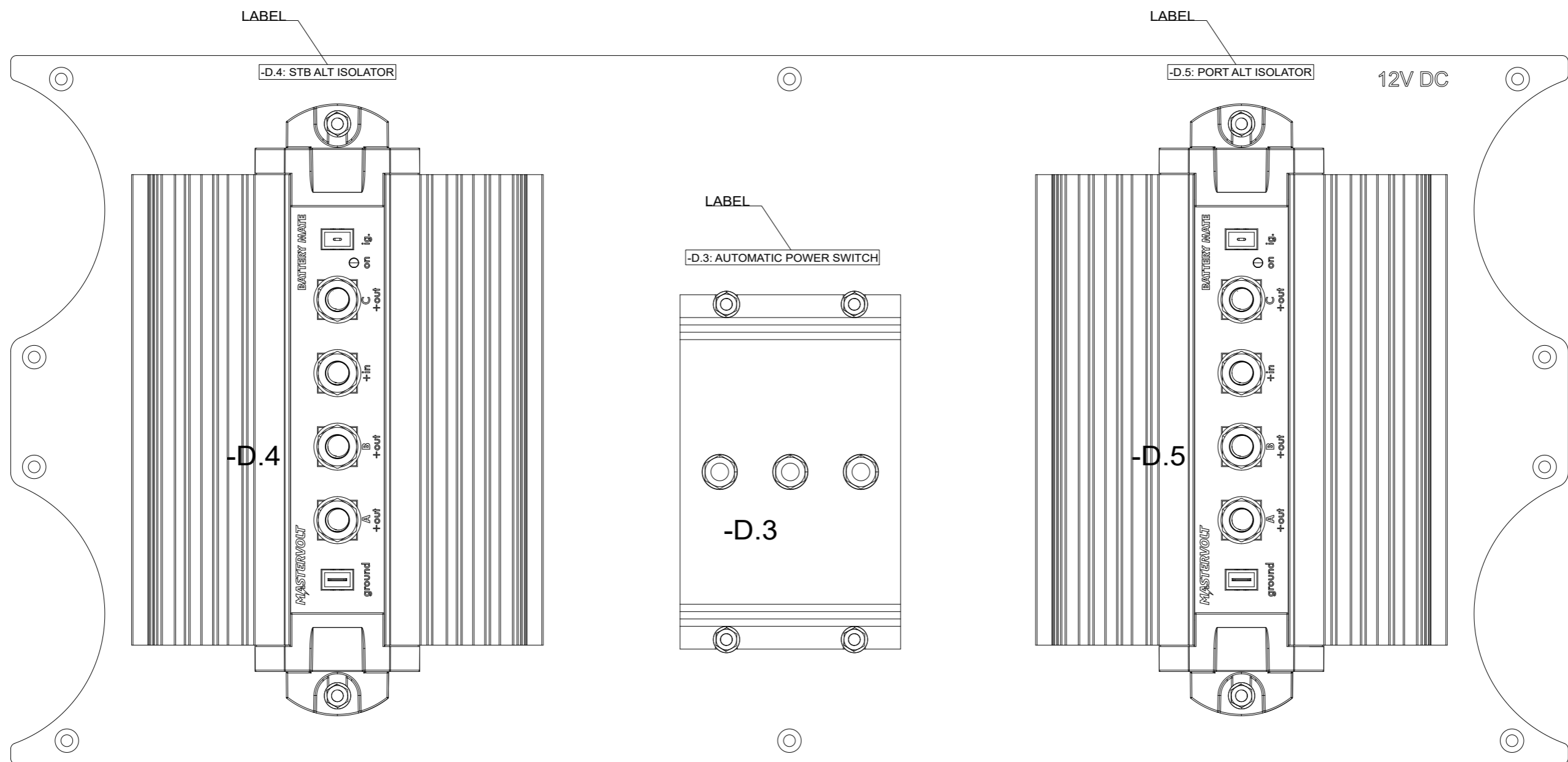

19.4.2024	PF	G5: 2005054; Not modified	Date	27.6.2019	 designed solutions Copyright by	Axopar	SEE EXP. VIEW	29618	Project ID
17.2.2023	RK	F4: NOT MODIFIED.	Drawing by	TuM		Boat	Sub-product code	Product code	
13.10.2023	PF	F5: 2004855; V10 update - isolators changed to Mastervolt	Sheet rev.	5	37 MY20	BATTERY BOX AFT WALL PANEL	HL	156 / 213	
Date of modification	Modified by	Description	Project rev.	G	Boat model		Title		Loc

GENERAL LAYOUT/ LABELS



19.4.2024	PF	G5: 2005054; Not modified	Date	27.6.2019		Axopar	SEE EXP. VIEW	29618	Project ID
17.2.2023	RK	F4: NOT MODIFIED.	Drawing by	TuM		Boat	Sub-product code	Product code	
13.10.2023	PF	F5: 2004855; V10 update - isolators changed to Mastervolt	Sheet rev.	5	Copyright by	37 MY20	BATTERY BOX	HL	157 / 213
Date of modification	Modified by	Description	Project rev.	G		Boat model	AFT WALL PANEL	Loc	

EXP VIEW

29618_AXOPAR_37_MY20_BATTERY_BOX_AFT_WALL_PANEL

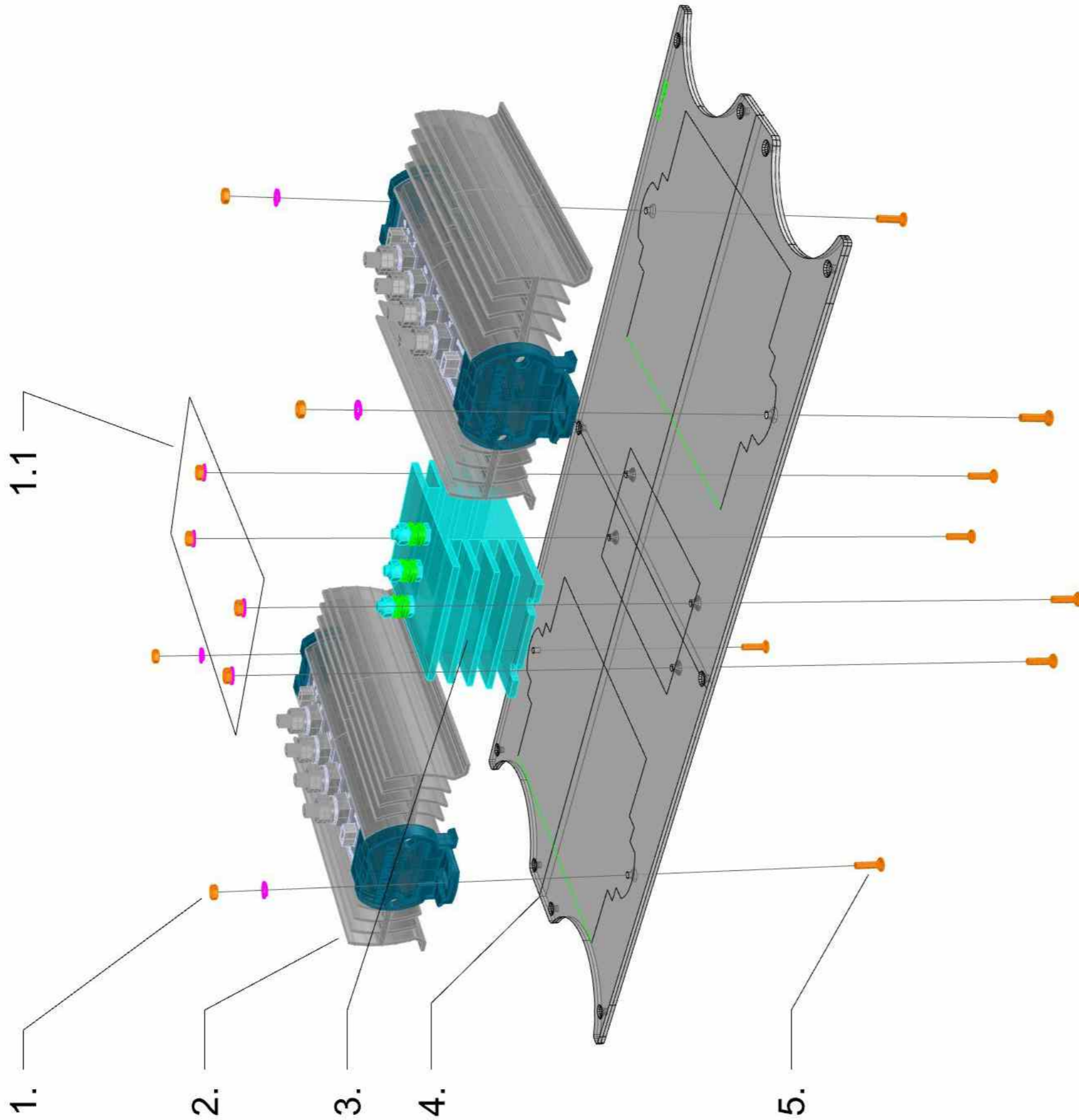

29618_AXOPAR_37_MY20_BATTERY_BOX_AFT_WALL_PANEL

- 1. 4 PCS M4 NUT A4
- 4 PCS M4 SPRING WASHER
- 4 PCS M4 WASHER
- 1.1 4 PCS M4 NUT A4
- 4 PCS M4 SPRING WASHER
- 4 PCS M4 WIDE WASHER
- 2. 2 PCS 38826 BATTERYMATE 2503 IG ISOLATOR 3-OUTPUT 200A
- 3. 1 PC 23655 VICTOR BCD 802 SOURCE COMBINER
- 4. 1 PC 29901_AXOPAR_37_MY20_BATTERY_BOX_AFT_WALL_PANEL_(WOC)_V4
- 5. 8 PCS M4L16 CS HEX BOLTS A4

TE 28.06.-19
TE 07.10.-19
MN 27.9.2023 (Project 2004855)

19.4.2024	PF	G5: 2005054; Not modified	Date	27.6.2019
17.2.2023	RK	F4: NOT MODIFIED.	Drawing by	TuM
13.10.2023	PF	F5: 2004855; V10 update - isolators changed to Mastervolt	Sheet rev.	5
Date of modification	Modified by	Description	Project rev.	G



Axopar
Boat
37 MY20
Boat model

SEE EXP. VIEW	29618	
Sub-product code	Product code	Project ID
BATTERY BOX	HL	158 / 213
AFT WALL PANEL	Loc	
Title		Sheet

NOTICE!
 VERIFY THAT ALL CABLES HAVE MARKINGS SHOWN IN EXAMPLE BELOW.
 EXEMPTION:
 ALL <500mm WIRES AND BLACK WIRES THIS MARKING IS NOT NEEDED.



CONNECTION TO HULL HARNESS

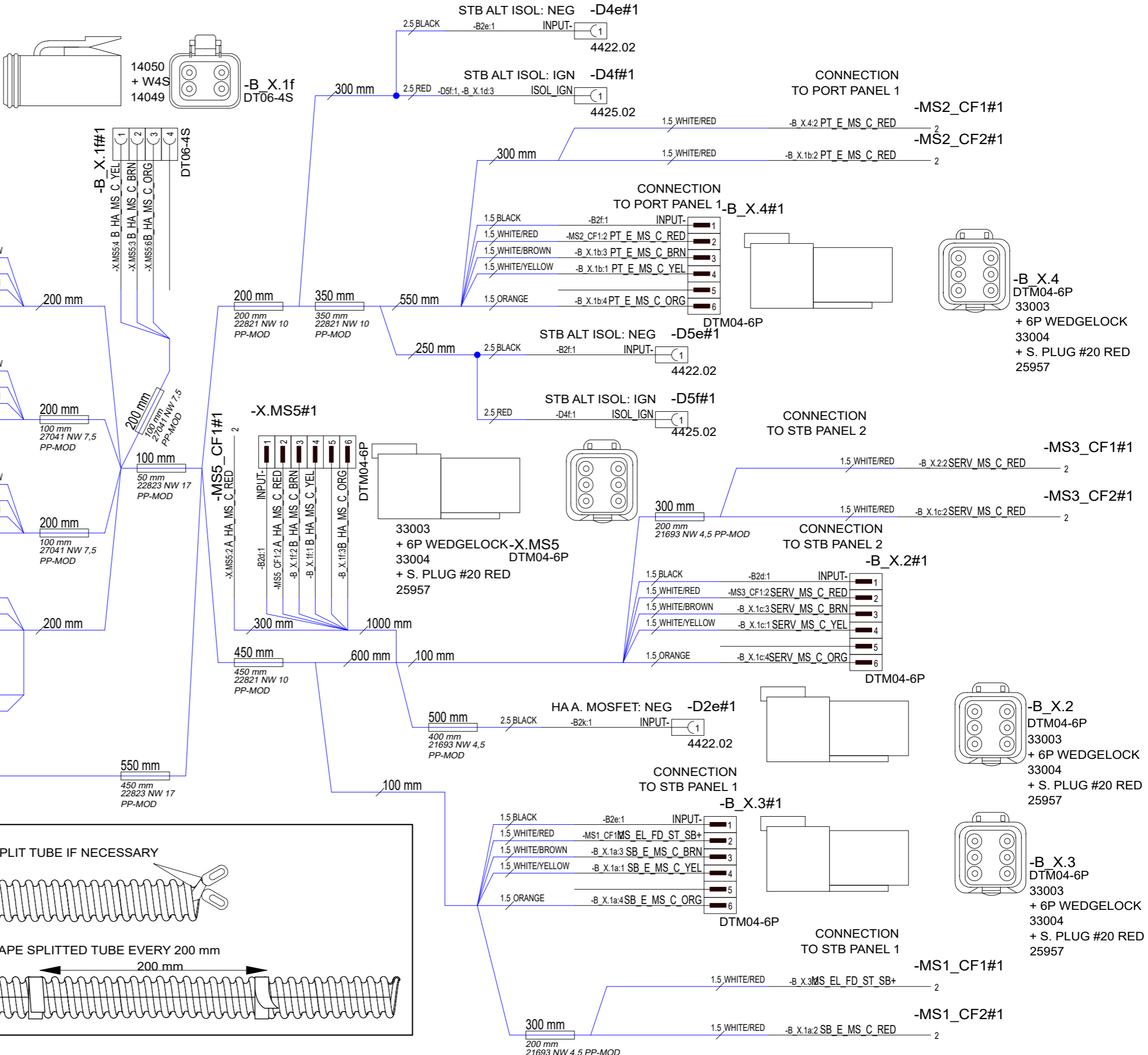
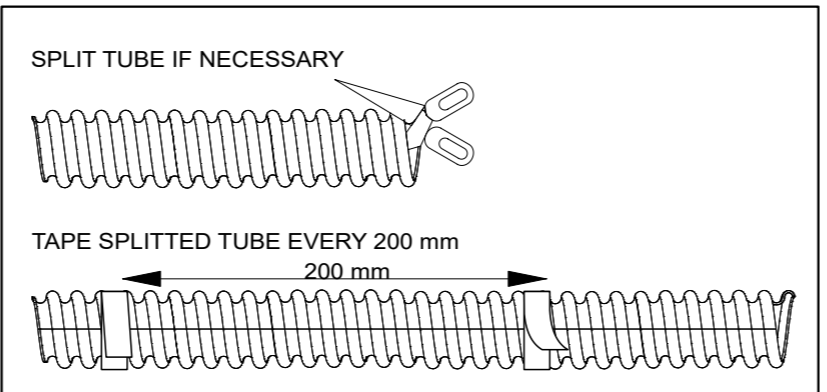
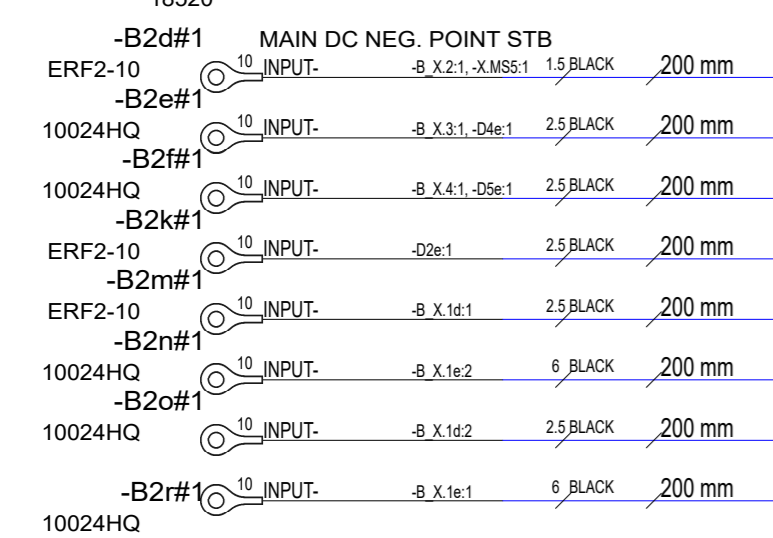
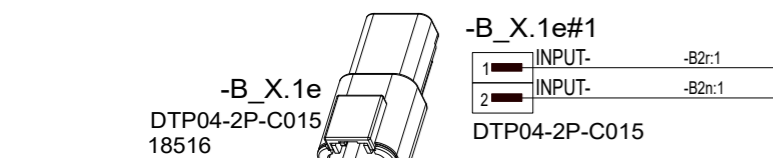
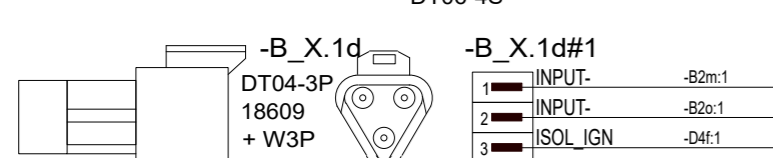
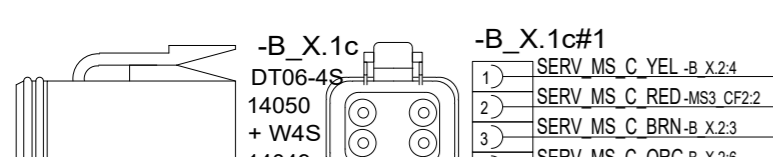
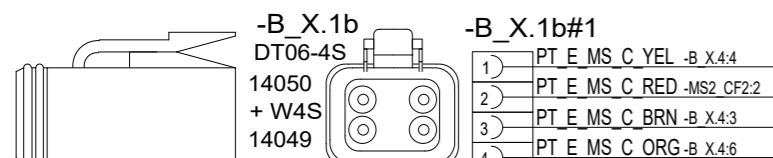
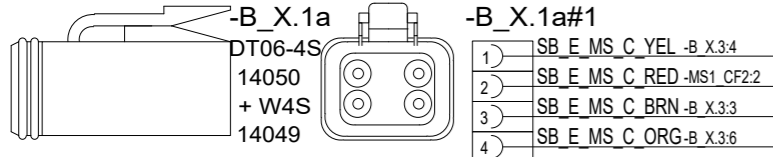

12.4.2024	PF	G8: 2005054; B_X1f & -X.MS5 added	Date	8.7.2019
22.9.2021	VV	E6: NOT MODIFIED / REVISION RETURNED TO REV. E.	Drawing by	TuM
17.2.2023	RK	F7: LENGTH MODIFICATIONS.	Sheet rev.	8
Date of modification	Modified by	Description	Project rev.	G



Axopar	Boat	37 MY20	Boat model	Sub-product code	29620	Product code	Project ID	159 / 213
BATTERY BOX HARNESS				HL	Loc		Sheet	

NOTICE!
 VERIFY THAT ALL CABLES HAVE MARKINGS
 SHOWN IN EXAMPLE BELOW.
 EXEMPTION:
 ALL <500mm WIRES AND BLACK WIRES
 THIS MARKING IS NOT NEEDED.

R2 ISO 6722 100V AWG16 +100 C
 EXAMPLE: RED 1,5mm² WIRE MARKINGS.

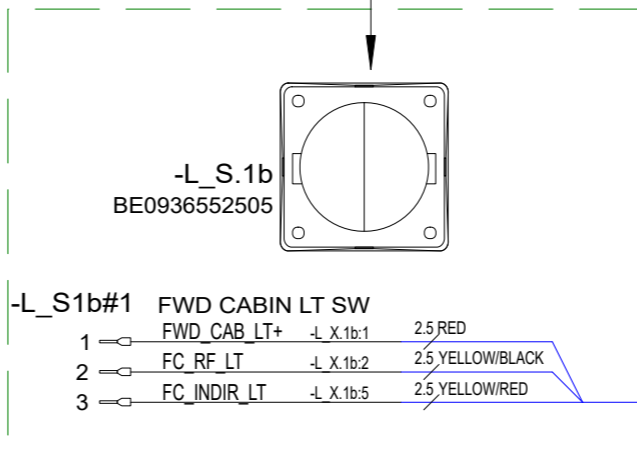
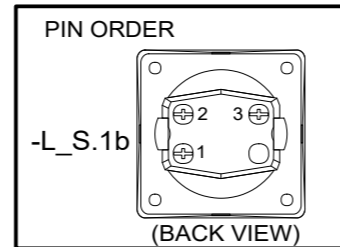
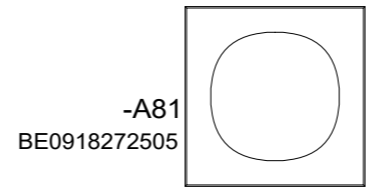
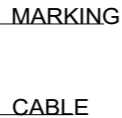

CONNECTION
 TO FWD CABIN HARNESS

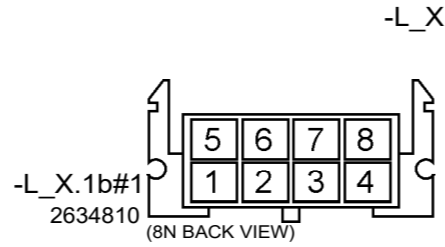

-L_X.1b#1			
1	FWD_CAB_LT+	-L_S1b:1	2.5 RED
2	FC_RF_LT	-L_S1b:2, -L_X.1b:3	2.5 YELLOW/BLACK
3	FC_RF_LT	-L_X.1b:2	2.5 YELLOW/BLACK
4	INPUT-	-L_X.1b:7	2.5 BLACK
5	FC_INDIR_LT	-L_S1b:3, -L_X.1b:6	2.5 YELLOW/RED
6	FC_INDIR_LT	-L_X.1b:5	2.5 YELLOW/RED
7	INPUT-	-L_X.1b:4, -L_X.1b:8	2.5 BLACK
8	INPUT-	-L_X.1b:7	2.5 BLACK

250 mm

4.4.2024	PF	G6: 2005054; Modified as option for light pack switch	Date	22.5.2019
22.9.2021	VV	E5: NOT MODIFIED / REVISION RETURNED TO REV. E.	Drawing by	TuM
17.2.2023	RK	F5: NOT MODIFIED.	Sheet rev.	6
Date of modification	Modified by	Description	Project rev.	G



Axopar	Boat	37 MY20	Boat model	FWD CABIN LIGHT SWITCH	HL	160 / 213
29635	Product code	29635	Product code	Project ID	Loc	Sheet

NOTICE!
 VERIFY THAT ALL CABLES HAVE MARKINGS
 SHOWN IN EXAMPLE BELOW.
 EXEMPTION:
 ALL <500mm WIRES AND BLACK WIRES
 THIS MARKING IS NOT NEEDED.

R2 ISO 6722 100V AWG16 +100 C
 EXAMPLE: RED 1,5mm² WIRE MARKINGS.

MARKING

CABLE

-A82
 BE0918272505

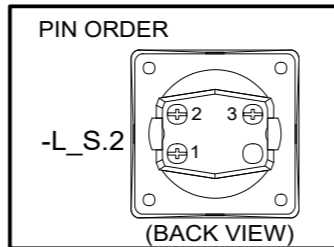
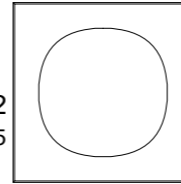

-L_S.2
 BE0936552505

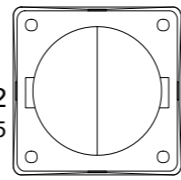

-L_S2#1 AFT CABIN LT SW

- 1 — AFT_CAB_LT+ -L_X.2:1 2,5 RED
- 2 — AC_RF_LT -L_X.2:2 2,5 YELLOW/BLACK
- 3 — AC_INDIR_LT -L_X.2:5 2,5 YELLOW/RED

CONNECTION
 TO AFT CABIN HARNESS

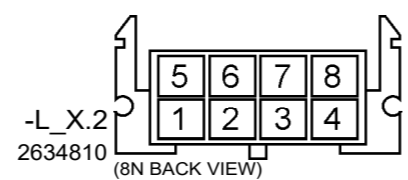

- 1 — AFT_CAB_LT+ -L_S2:1 2,5 RED
- 2 — AC_RF_LT -L_S2:2,-L_X.2:3 2,5 YELLOW/BLACK
- 3 — AC_RF_LT -L_X.2:2 2,5 YELLOW/BLACK
- 4 — INPUT- -L_X.2:7 2,5 BLACK
- 5 — AC_INDIR_LT -L_S2:3,-L_X.2:6 2,5 YELLOW/RED
- 6 — AC_INDIR_LT -L_X.2:5 2,5 YELLOW/RED
- 7 — INPUT- -L_X.2:8,-L_X.2:4 2,5 BLACK
- 8 — INPUT- -L_X.2:7 2,5 BLACK

250 mm

2634810

22.9.2021	VV	E3: NOT MODIFIED / REVISION RETURNED TO REV. E.
17.2.2023	RK	F3: NOT MODIFIED.
4.4.2024	PF	G4: 2005054; Modified as option for light pack switch
Date of modification	Modified by	Description

Date	22.5.2019
Drawing by	TuM
Sheet rev.	4
Project rev.	G



Axopar
Boat
37 MY20
Boat model

Sub-product code	29636	Product code	Project ID
AFT CABIN LIGHT SWITCH		HL	161/ 213
Title	Loc	Sheet	

NOTICE!
 BATTERY CABLES NEED TO ADD MARKINGS
 SHOWN IN EXAMPLE BELOW.
 EXEMPTION:
 ALL BLACK WIRES
 THIS MARKING IS NOT NEEDED.

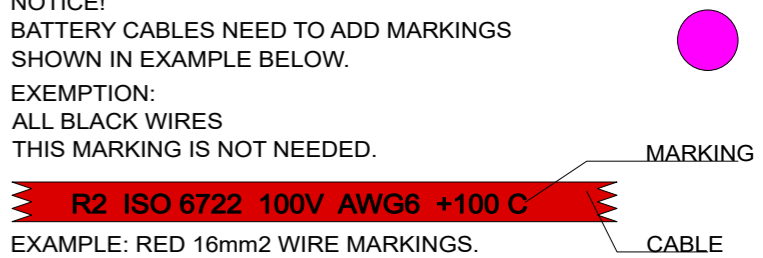

EXAMPLE: RED 16mm2 WIRE MARKINGS.

MARKING SHOWN ABOVE ONLY TO CABLES LISTED BELOW.

EQUIVALENCY:	
mm2	AWG
10 mm2	= AWG8
16 mm2	= AWG6
25 mm2	= AWG3
35 mm2	= AWG2

LOOK FOR EQUIVALENT AWG SIZE FOR mm2
 AND ADD THIS TO CABLE MARKINGS.

FOR EXAMPLE:
 CABLE SIZE IS 25mm2 --> MARKING AWG3.

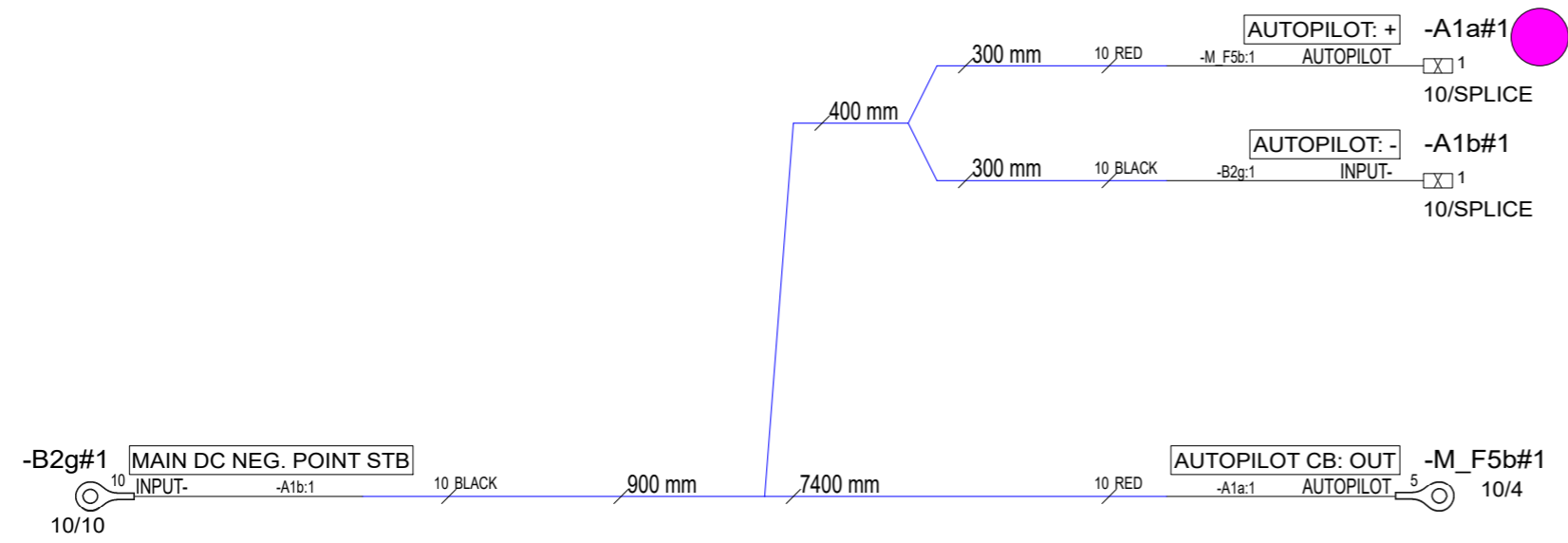

12.4.2024	PF	G3: 2005054; Not modified	Date	25.9.2019	 Copyright by	Axopar			
22.9.2021	VV	E3: NOT MODIFIED / REVISION RETURNED TO REV. E.	Drawing by	TuM		Boat		30736	
17.2.2023	RK	F3: NOT MODIFIED.	Sheet rev.	3		37 MY20	Sub-product code	Product code	Project ID
Date of modification	Modified by	Description	Project rev.	G		Boat model	AUTOPILOT HARNESS Title	HL	163 / 213
1	2	3	4	5	6	7	8	Sheet	

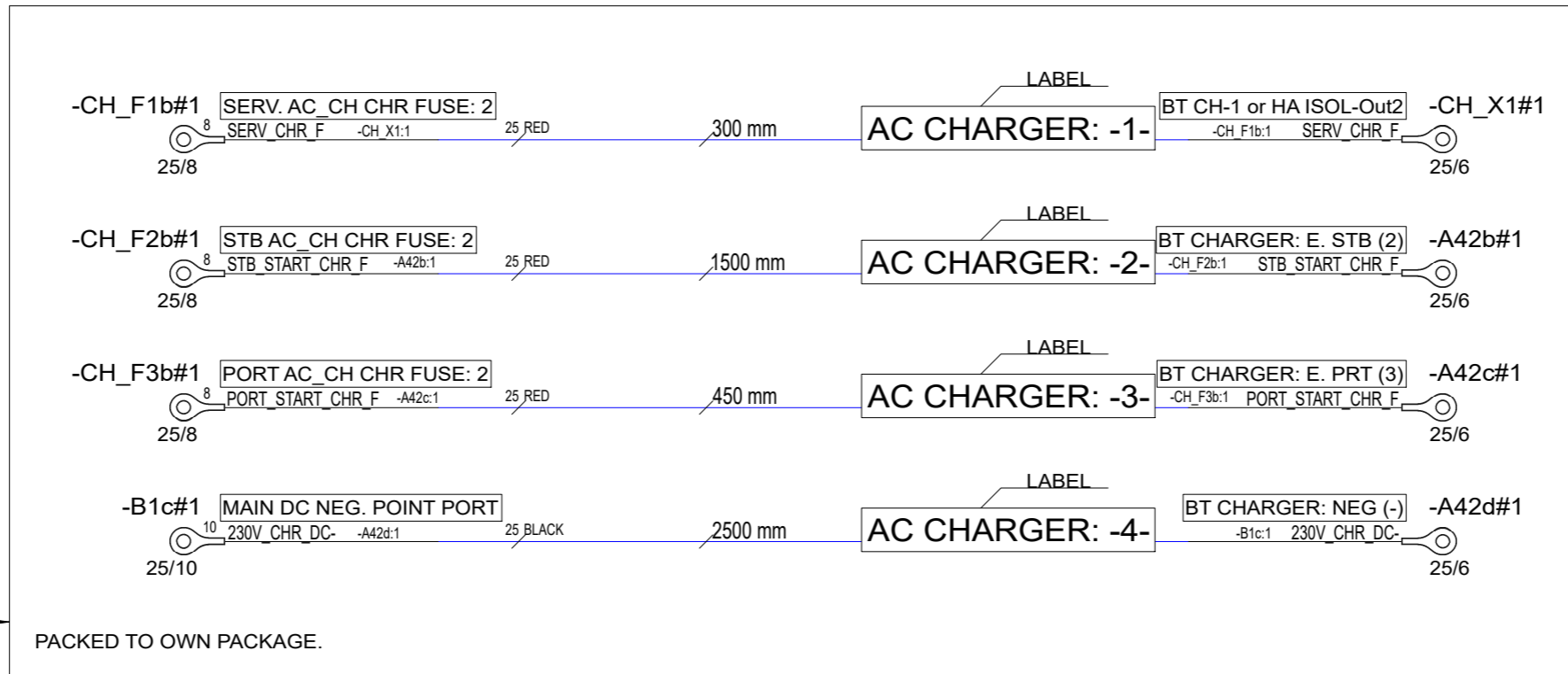
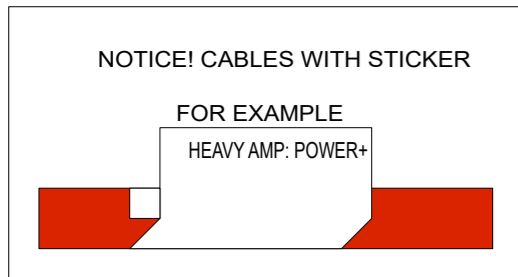

AC CHARGER CABLES

(TO TOP OF PACKAGE)

NOTICE!
BATTERY CABLES NEED TO ADD MARKINGS
SHOWN IN EXAMPLE BELOW.

EXEMPTION:
ALL BLACK WIRES
THIS MARKING IS NOT NEEDED.

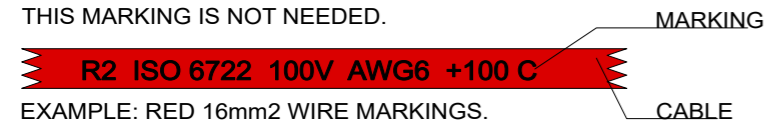

MARKING SHOWN ABOVE ONLY TO CABLES LISTED BELOW.

EQUIVALENCY:

mm ²	AWG
10 mm ²	= AWG8
16 mm ²	= AWG6
25 mm ²	= AWG3
35 mm ²	= AWG2

LOOK FOR EQUIVALENT AWG SIZE FOR mm²
AND ADD THIS TO CABLE MARKINGS.

FOR EXAMPLE:
CABLE SIZE IS 25mm² --> MARKING AWG3.

19.4.2024	PF	G4: 2005054; Not modified	Date	26.9.2019	NAVIX designed solutions	Axopar			
22.9.2021	VV	E4: NOT MODIFIED / REVISION RETURNED TO REV. E.	Drawing by	TuM		Boat	37 MY20	Sub-product code	30737
17.2.2023	RK	F4: NOT MODIFIED.	Sheet rev.	4	Copyright by		BATTERY BOX CHARGER CABLES	HL	Project ID
Date of modification	Modified by	Description	Project rev.	G		Boat model	Title	Loc	164 / 213 Sheet

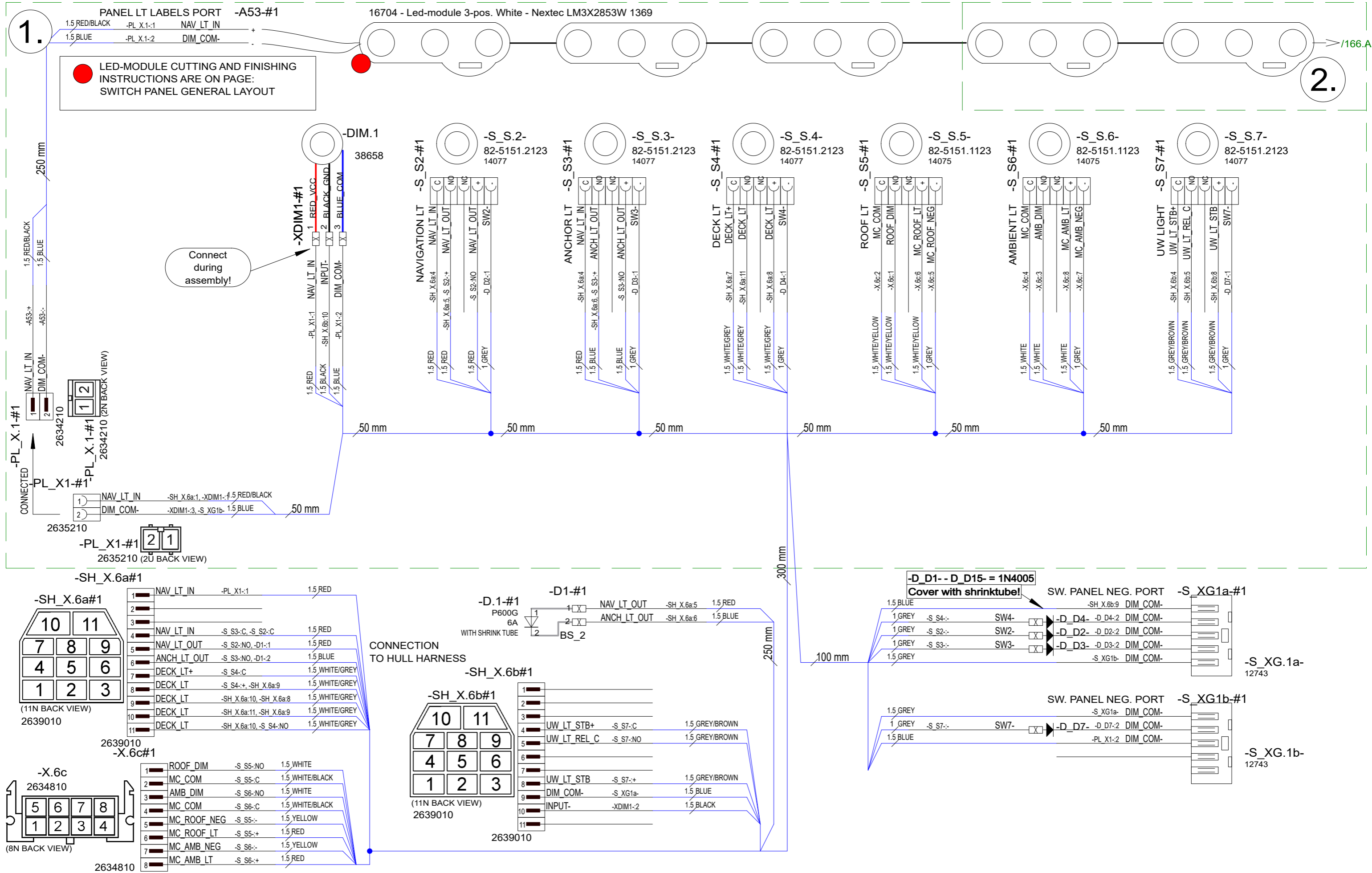

17.2.2023	RK	F8: NOT MODIFIED
16.10.2023	PF	F9: 2004916; Added dimming feature, F10: Bilge halo dimming removed
15.03.2024	PF	G11:2005054; Added s15, S1 replaced with dimmer, test insntruction update
Date of modification	Modified by	Description

Date	6.11.2019
Drawing by	TuM
Sheet rev.	11
Project rev.	G



Axopar	SEE EXP VIEW	30810	Project ID
Boat	Sub-product code	Product code	
37 MY20 SHADOW	SWITCH PANEL	HL	165 / 213
Boat model	Title	Loc	

2.

LED-MODULE CUTTING AND FINISHING INSTRUCTIONS ARE ON PAGE: SWITCH PANEL GENERAL LAYOUT

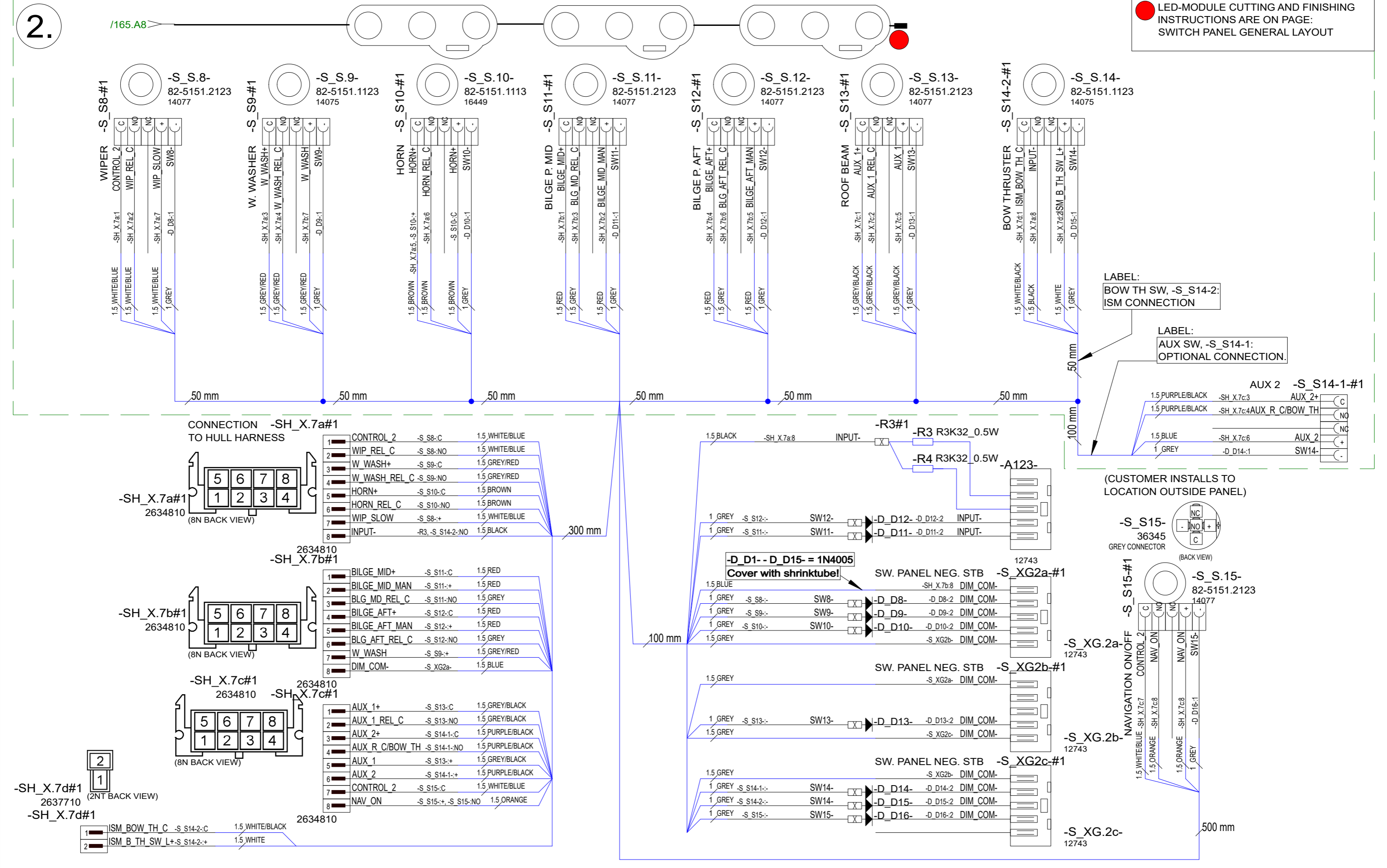

17.2.2023	RK	F8: NOT MODIFIED
16.10.2023	PF	F9: 2004916; Added dimming feature, F10: Bilge halo dimming removed
15.03.2024	PF	G11:2005054; Added s15, S1 replaced with dimmer, test insruction update
Date of modification	Modified by	Description

Date	6.11.2019
Drawing by	TuM
Sheet rev.	11
Project rev.	G



Axopar
Boat
37 MY20 SHADOW
Boat model

SEE EXP VIEW	30810	Project ID
Sub-product code	Product code	
SWITCH PANEL	HL	166 / 213
Title	Loc	

SWITCH PANEL GENERAL LAYOUT / LED MODULE CUTTING & FINISHING

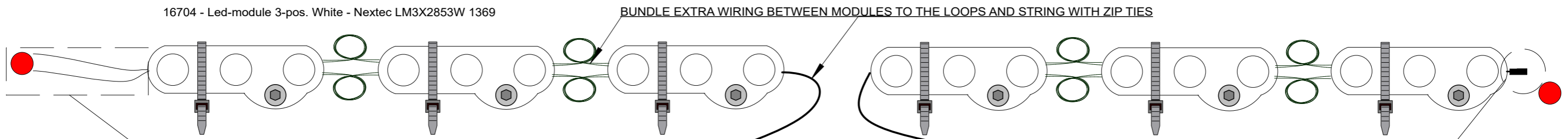
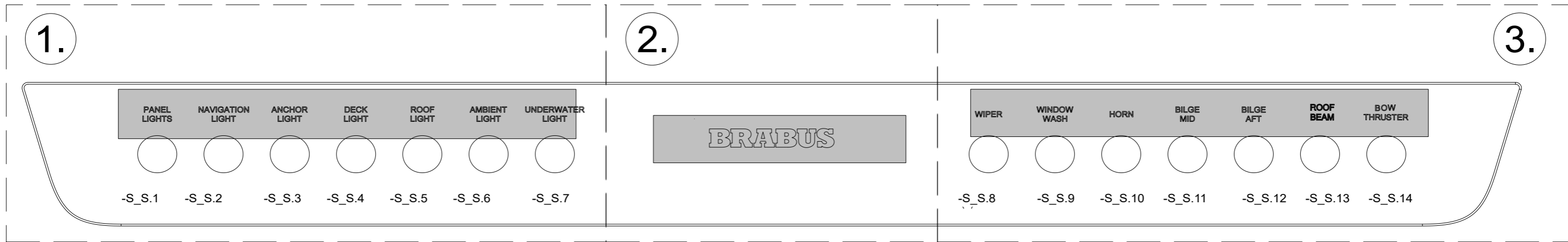

16704 - Led-module 3-pos. White - Nextec LM3X2853W 1369

BUNDLE EXTRA WIRING BETWEEN MODULES TO THE LOOPS AND STRING WITH ZIP TIES

CUT LED MODULES INPUT SIDE OF THE WIRES APPROX. 60mm LENGTH (SHOULD BE ABOUT THE CENTER POS. BETWEEN 2 MODULES)
STRIP WIRE ENDS APPROX. 7mm AND CRIMP WIRES TO THE BUTT SPLICE CONNECTORS -A53.

1. CUT THE WIRES APPROX. 40mm. (JUST CUT, DO NOT STRIP!)
2. BEND THE WIRES TO THE SHAPE OF "U".
3. ADD APPROX. 20mm OF HEAT SHRINK TUBE "17418" OVER THE BENDED WIRES.

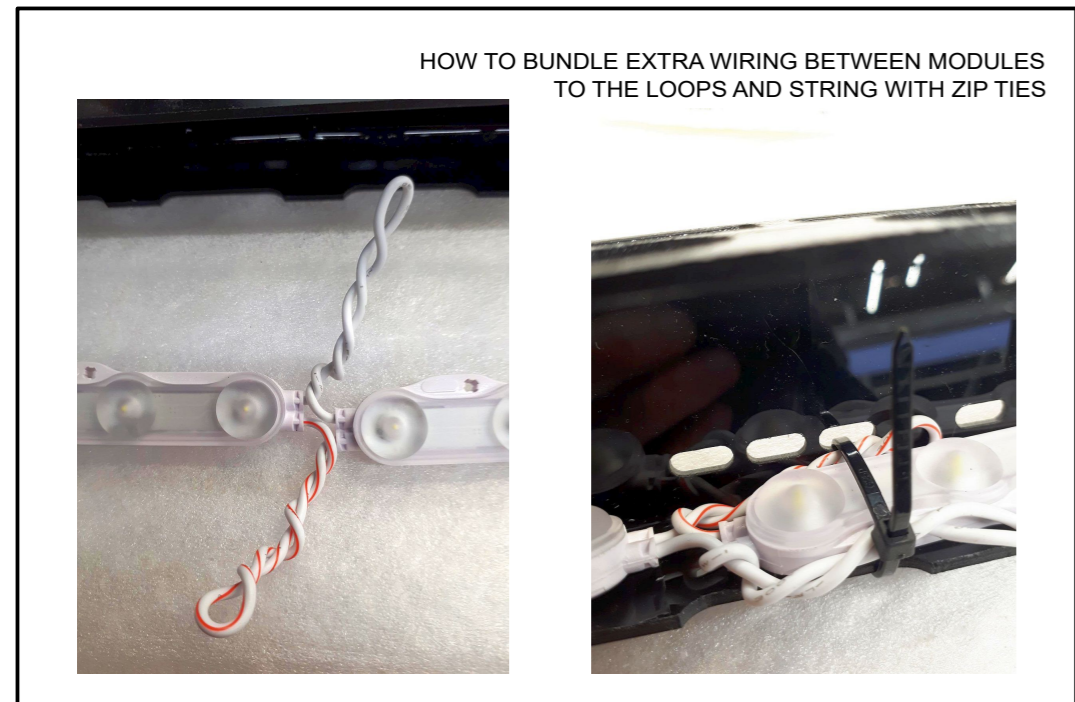
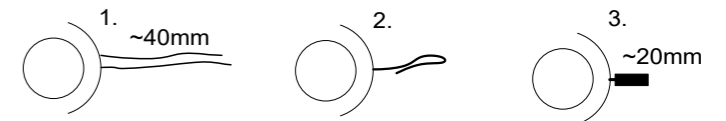

HOW TO BUNDLE EXTRA WIRING BETWEEN MODULES TO THE LOOPS AND STRING WITH ZIP TIES

ATTACH ALL LED MODULES TO THE BRACKET 36371 WITH M3X12 BH HEX BOLT A4, NUT M3 AND 2-SIDED TAPE. ADD CABLE TIE. SEE ALSO EXP. VIEW
TURN THE ENDS OF CABLE TIES TOWARDS TO THE PANEL!

NOTICE!
VERIFY THAT ALL CABLES HAVE MARKINGS SHOWN IN EXAMPLE BELOW.
EXEMPTION:
ALL <500mm WIRES AND BLACK WIRES THIS MARKING IS NOT NEEDED.

EXAMPLE: RED 1,5mm² WIRE MARKINGS.

17.2.2023	RK	F8: NOT MODIFIED	Date	6.11.2019	NAVIX designed solutions	Axopar	SEE EXP VIEW	30810	Project ID
16.10.2023	PF	F9: 2004916; Added dimming feature, F10: Bilge halo dimming removed	Drawing by	TuM		Boat	Sub-product code	Product code	
15.03.2024	PF	G11:2005054; Added s15, S1 replaced with dimmer, test insruction update	Sheet rev.	11	Copyright by	37 MY20 SHADOW	SWITCH PANEL	HL	167 / 213 Sheet
Date of modification	Modified by	Description	Project rev.	G	Boat model	Title	Loc		

30810_AXOPAR_37_MY_20_SHADOW_SWITCH_PANEL

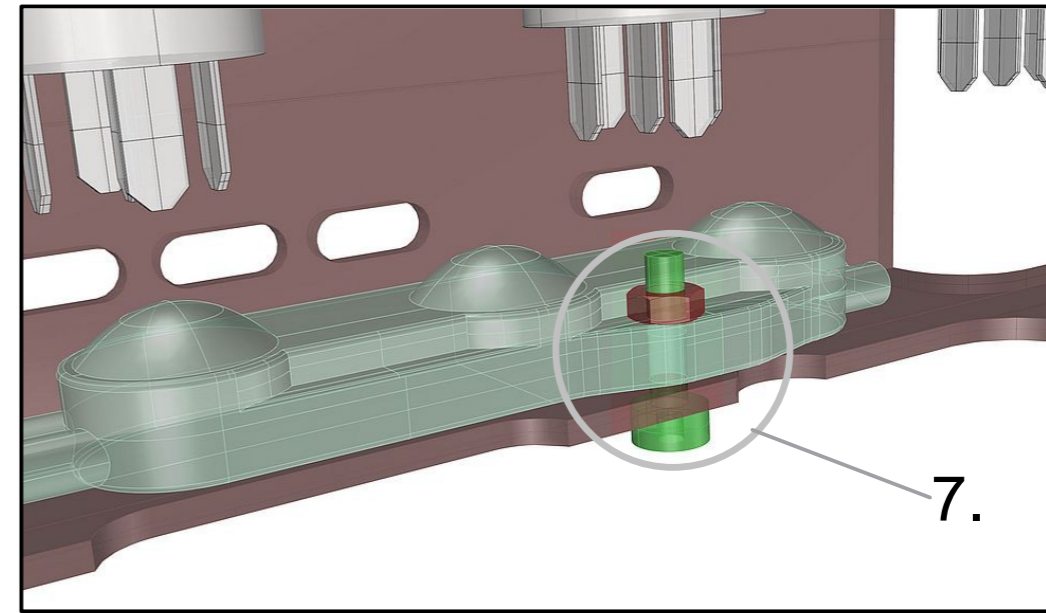
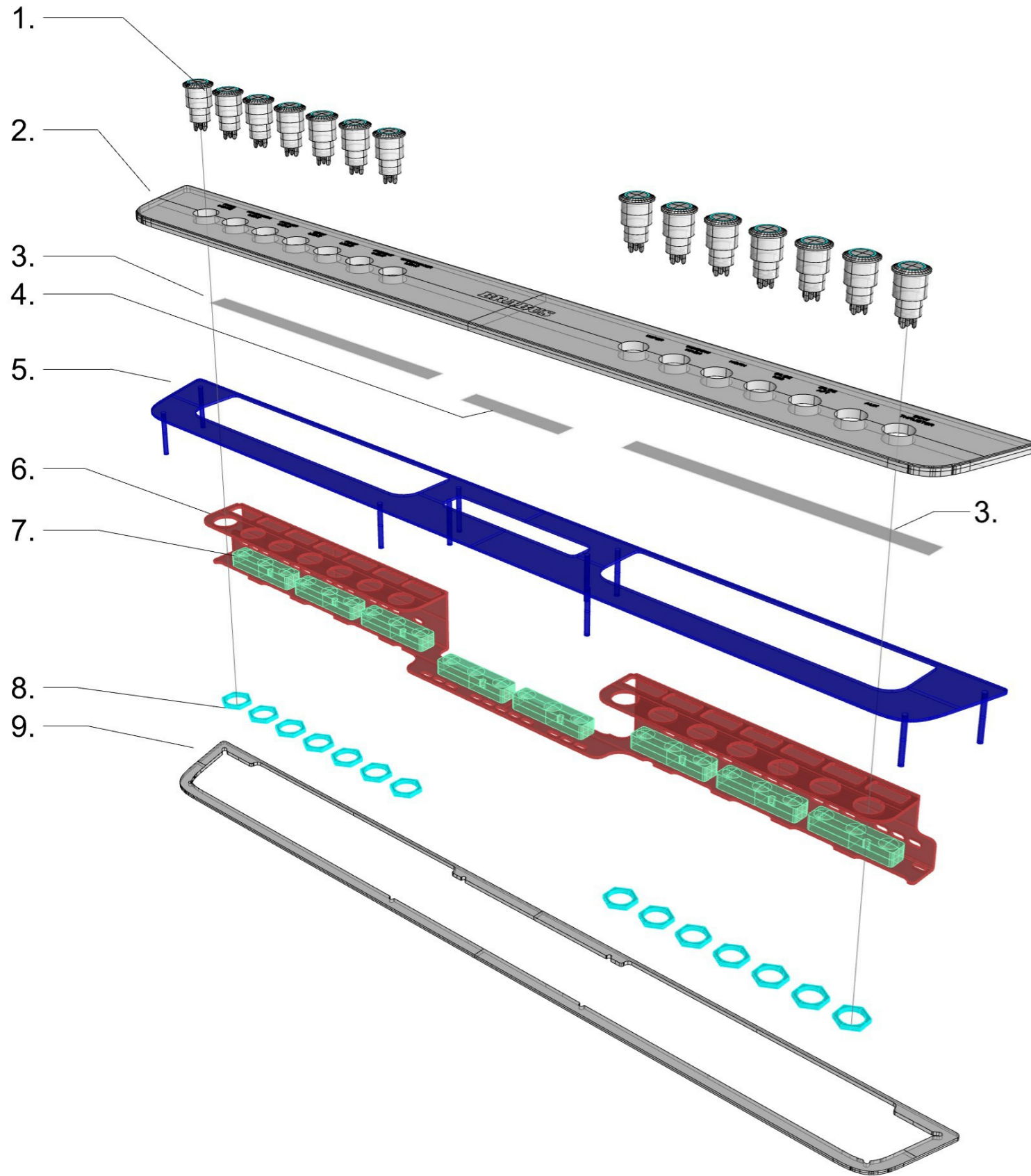

30810_AXOPAR_37_MY_20_SHADOW_SWITCH_PANEL

1. 14PCS HALO SWITCH (AS IN DIAGRAM)
2. 1PC 31118_AXOPAR_37_MY_20_SHADOW_ACRYL_SWITCH_PANEL_(WOC)
3. 2PCS 29771_AXOPAR_37_MY20_SWITCH_PANEL_TEXT_STICKER
(PLACE BEHIND THE TEXT AREA IN 31118)
4. 1PC 28309_AXOPAR_37_SHADOW_SWITCH_PANEL_LOGO_STICKER
(PLACE BEHIND THE TEXT AREA IN 31118)
5. 1PC 29768_AXOPAR_37_MY20_SWITCH_PANEL_METAL_BACK_FRAME
ATTACH TO 31118 WITH BLACK MS-POLYMER GLUE
6. 1PC 36371_AXOPAR_SWITCH_PANEL_LED_MODULE_BRACKET_(WOC)
7. 8PCS 16704 LED MODULE WHITE ATTATCH TO 36371 WITH M3X12 BH HEX BOLT A4 AND NUT
ATTACH TO BRACKET WITH CABLE TIES AND 2-SIDED TAPE
8. 14PCS HALO SWITCH NUT
9. 1PCS 29769_AXOPAR_37_MY20_SWITCH_PANEL_GASKET_(WOC)
GLUE WITH 2-SIDED TAPE TO THE BACKSIDE OF 29768

TE 30.10.2019
 MN 18.11.2019
 TE 11.01.2021
 HL 11.03.2022

EXP VIEW

17.2.2023	RK	F8: NOT MODIFIED	Date	6.11.2019
16.10.2023	PF	F9: 2004916; Added dimming feature, F10: Bilge halo dimming removed	Drawing by	TuM
15.03.2024	PF	G11:2005054; Added s15, S1 replaced with dimmer, test insntruction update	Sheet rev.	11
Date of modification	Modified by	Description	Project rev.	G



Axopar	SEE EXP VIEW	30810	Project ID
Boat	Sub-product code	Product code	
37 MY20 SHADOW	SWITCH PANEL	HL	168 / 213 Sheet
Boat model	Title	Loc	

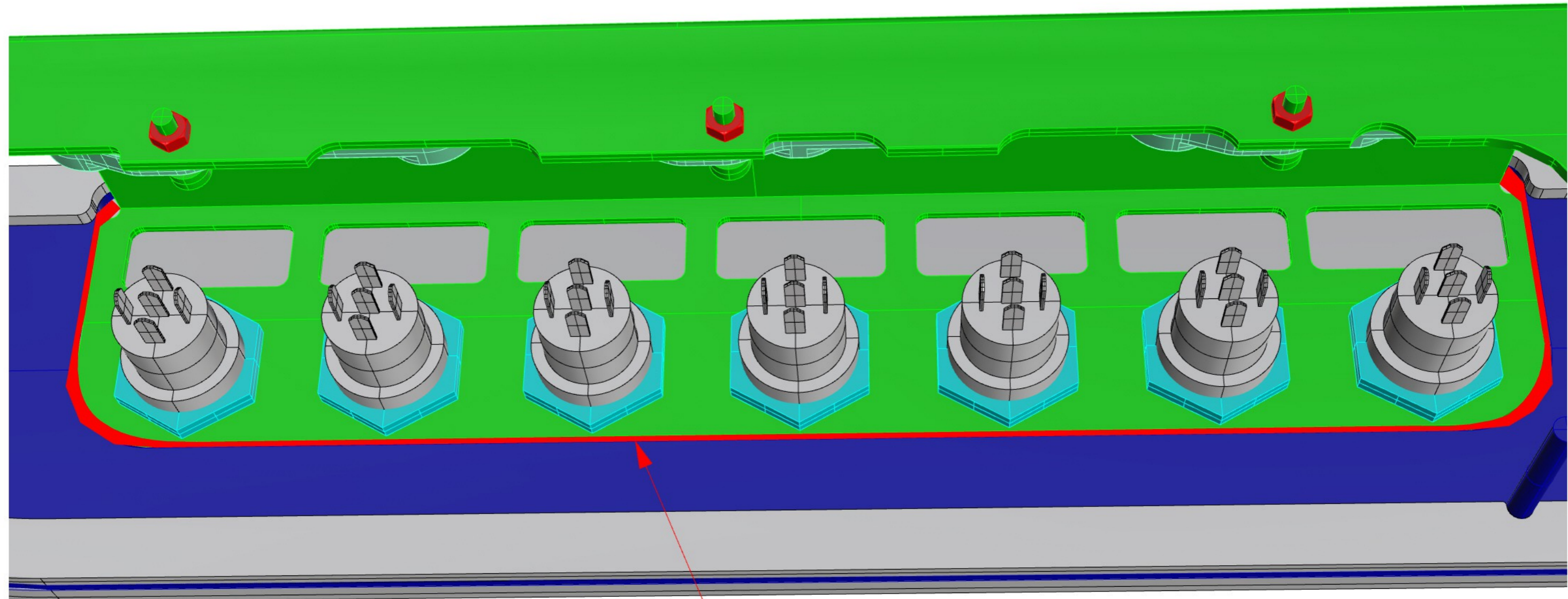

FILL THE GAP BETWEEN
 METAL FRAME AND LED BRACKET
 WITH 21119 MS-POLYMER BLACK GLUE
 GLUE MUST BE FLUSH WITH PANELS

17.2.2023	RK	F8: NOT MODIFIED.
16.10.2023	PF	F9: 2004916; Added dimming feature, F10: Bilge halo dimming removed
15.03.2024	PF	G11:2005054; Added s15, S1 replaced with dimmer, test insruction update
Date of modification	Modified by	Description

Date	6.11.2019
Drawing by	TuM
Sheet rev.	11
Project rev.	G



Axopar
Boat
37 MY20 SHADOW
Boat model

SEE EXP. VIEW
Sub-product code
SWITCH PANEL
Title

30810
Product code
HL
Loc

Project ID
169 / 213
Sheet

Axopar 37 MY20 SWITCH PANEL 30810 INSPECTION SHEET

PRUDUCT LABEL

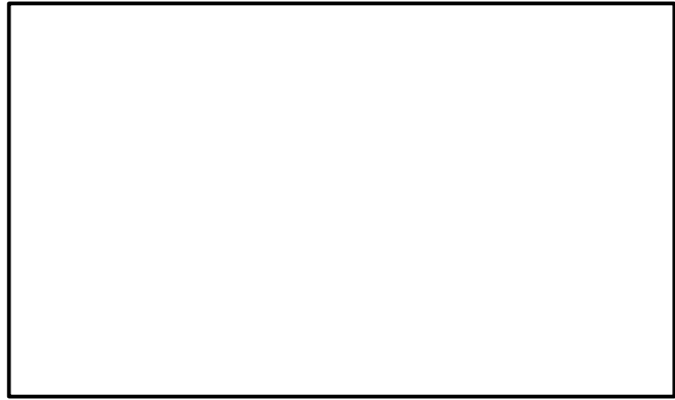

TEST

- 1) S2, S3, S4 should be pressed. No other buttons may be pressed during entire test. Power source off.
- 2) Connect -X.6b/9 and -X.7b/8 with a wire.
- 3) Connect positive (+12V) to connectors listed below
- 4) Connect negative (-) to -X.6b/10 and -X.7a/8. Turn power on.
- 5) Observe, change brightness and turn on/off by pressing DIM1. Panel lights and switch halos must illuminate. S11 and S12 should illuminate constantly with full brightness, S5 and S6 should not illuminate at all. All other lights should turn on/off/dim from DIM1.

Connect positive (+)
 SH_X.6a/1
 SH_X.6a/4
 SH_X.6a/7
 SH_X.6b/8
 SH_X.7a/7
 SH_X.7b/7
 SH_X.7a/5
 SH_X.7b/2
 SH_X.7b/5
 SH_X.7c/5
 SH_X.7c/6
 SH_X.7d/4

Connect negative (-)
 SH_X.6b/10
 SH_X.7a/8

PASS / FAIL

DATE

TESTED BY

TEST INSTRUCTIONS

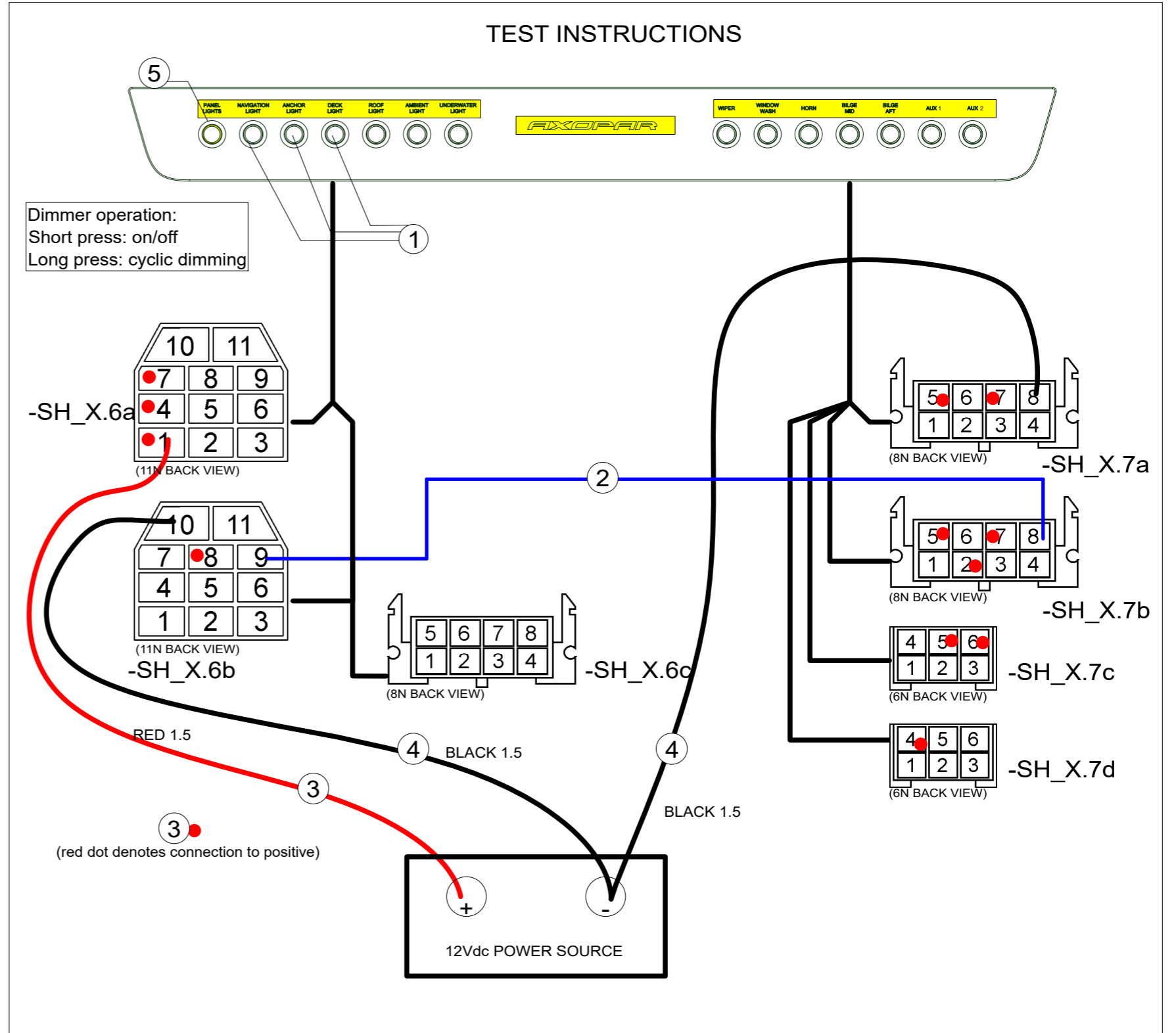

17.2.2023	RK	F8: NOT MODIFIED
16.10.2023	PF	F9: 2004916; Added dimming feature, F10: Bilge halo dimming removed
15.03.2024	PF	G11:2005054; Added s15, S1 replaced with dimmer, test insntruction update
Date of modification	Modified by	Description

Date	6.11.2019
Drawing by	TuM
Sheet rev.	11
Project rev.	G



Axopar
Boat
37 MY20 SHADOW
Boat model

SEE EXP VIEW
Sub-product code
SWITCH PANEL
Title

30810
Product code
HL
Loc

Project ID
170 / 213
Sheet

1.

-F_X1
MAIN SUPPLY CONNECTION

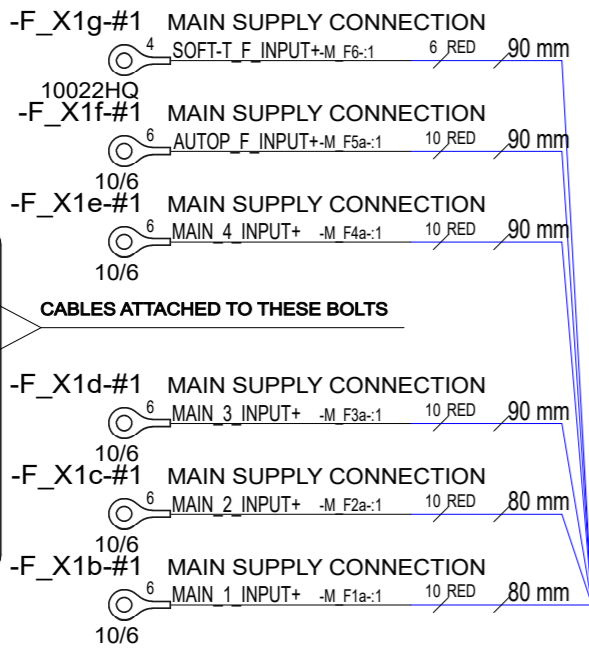
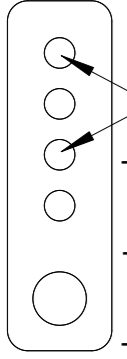

CABLES ATTACHED TO THESE BOLTS

-F_X2
DIRECT SUPPLY CONNECTION

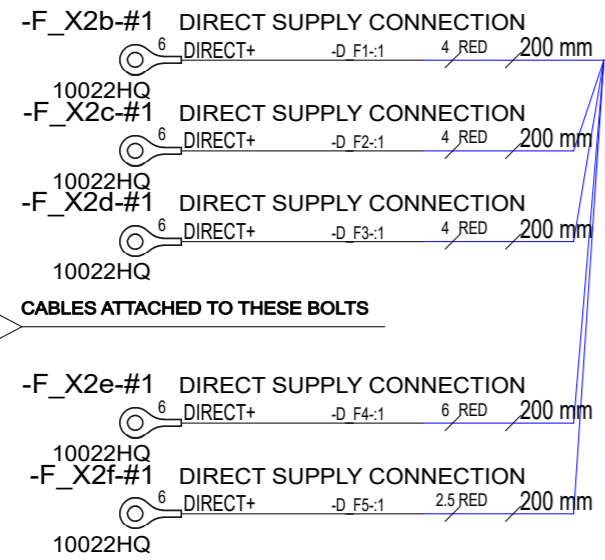
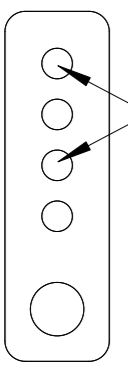

CABLES ATTACHED TO THESE BOLTS

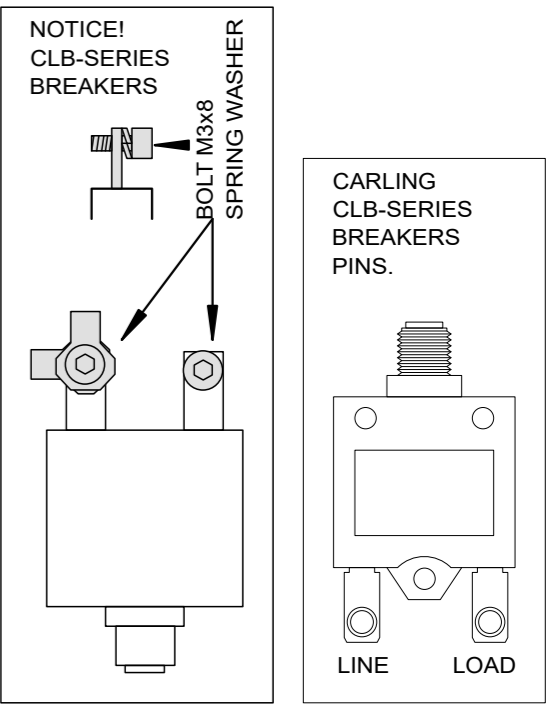

23.11.2023	PF	F10: 2004954; Changed livewell fuse to 3A	Date	24.4.2020
13.4.2024	PF	G11: 2005054; F47 10A->16A	Drawing by	TuM
17.2.2023	RK	F9: -F18 NOW USED FOR WETBAR LT	Sheet rev.	11
Date of modification	Modified by	Description	Project rev.	G



Axopar	SEE EXP VIEW	30811	Project ID
Boat	Sub-product code	Product code	
37 MY20 SHADOW	FUSE UNIT	HL	171/ 213
Boat model	Title	Loc	

2.



23.11.2023	PF	F10: 2004954; Changed livewell fuse to 3A
13.4.2024	PF	G11: 2005054; F47 10A->16A
17.2.2023	RK	F9: -F18 NOW USED FOR WETBAR LT
Date of modification	Modified by	Description

Date	24.4.2020
Drawing by	TuM
Sheet rev.	11
Project rev.	G



Axopar
Boat
37 MY20 SHADOW
Boat model

SEE EXP VIEW	30811	Project ID
Sub-product code	Product code	
FUSE UNIT	HL	172 / 213 Sheet
Title	Loc	

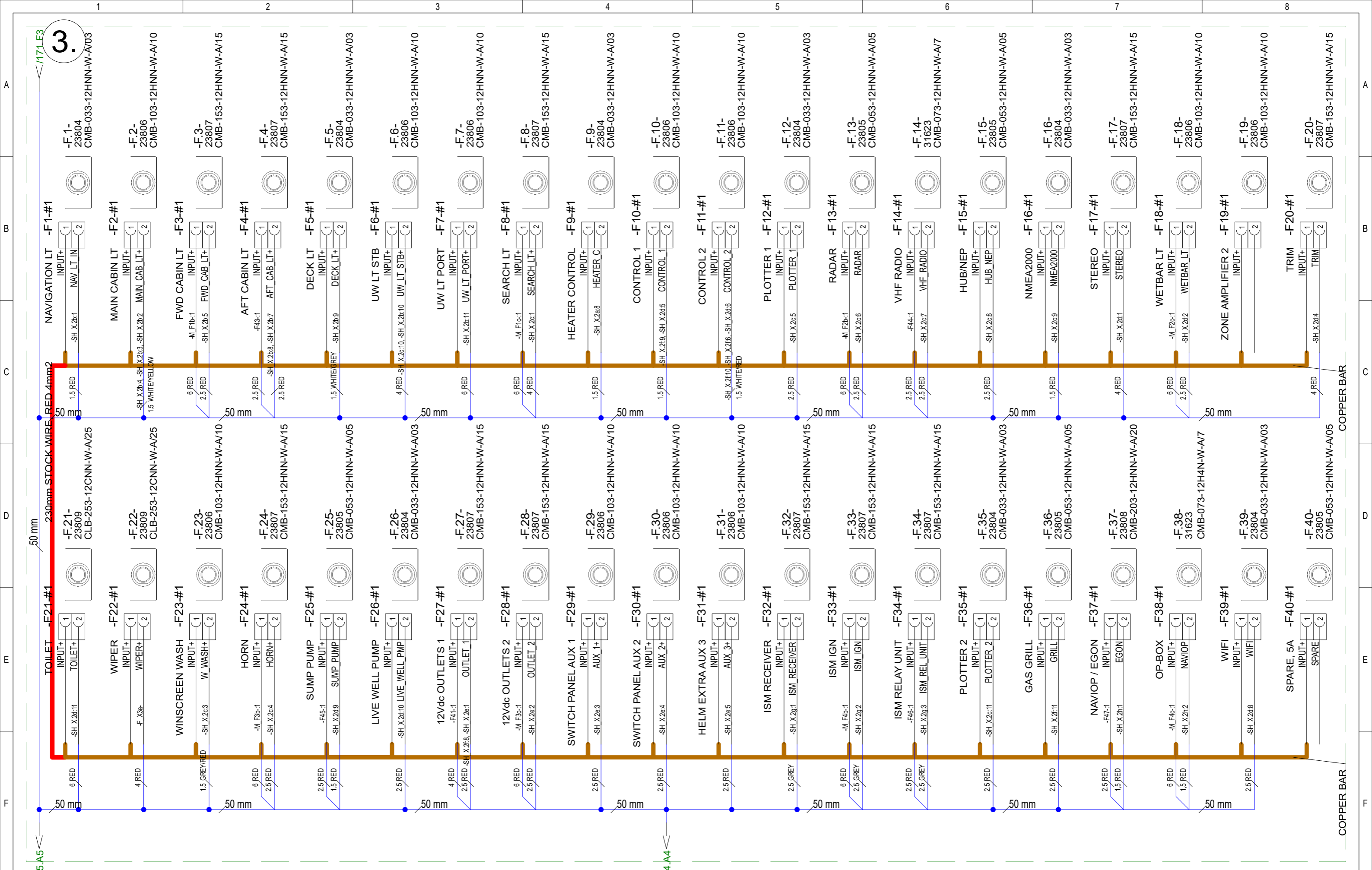

23.11.2023	PF	F10: 2004954; Changed livewell fuse to 3A	Date	24.4.2020
13.4.2024	PF	G11: 2005054; F47 10A->16A	Drawing by	TuM
17.2.2023	RK	F9: -F18 NOW USED FOR WETBAR LT	Sheet rev.	11
Date of modification	Modified by	Description	Project rev.	G



Axopar
Boat
37 MY20 SHADOW
Boat model

SEE EXP VIEW	30811	Project ID
Sub-product code	Product code	
FUSE UNIT	HL	173 / 213
Title	Loc	

4.

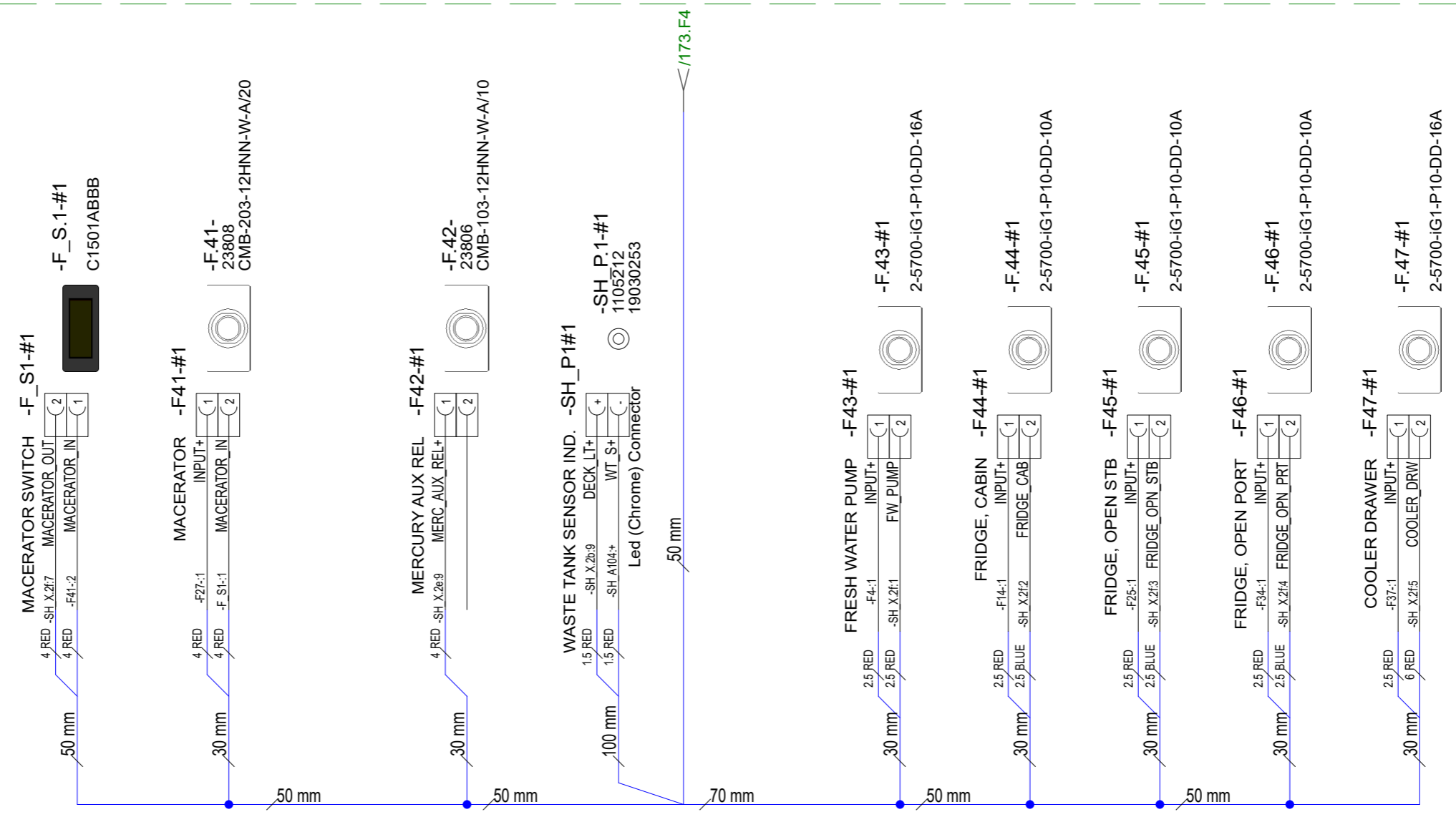

23.11.2023	PF	F10: 2004954; Changed livewell fuse to 3A
13.4.2024	PF	G11: 2005054; F47 10A->16A
17.2.2023	RK	F9: -F18 NOW USED FOR WETBAR LT
Date of modification	Modified by	Description

Date	24.4.2020
Drawing by	TuM
Sheet rev.	11
Project rev.	G



Axopar
Boat
37 MY20 SHADOW
Boat model

SEE EXP VIEW	30811	Project ID
Sub-product code	Product code	
FUSE UNIT	HL	174 / 213
Title	Loc	

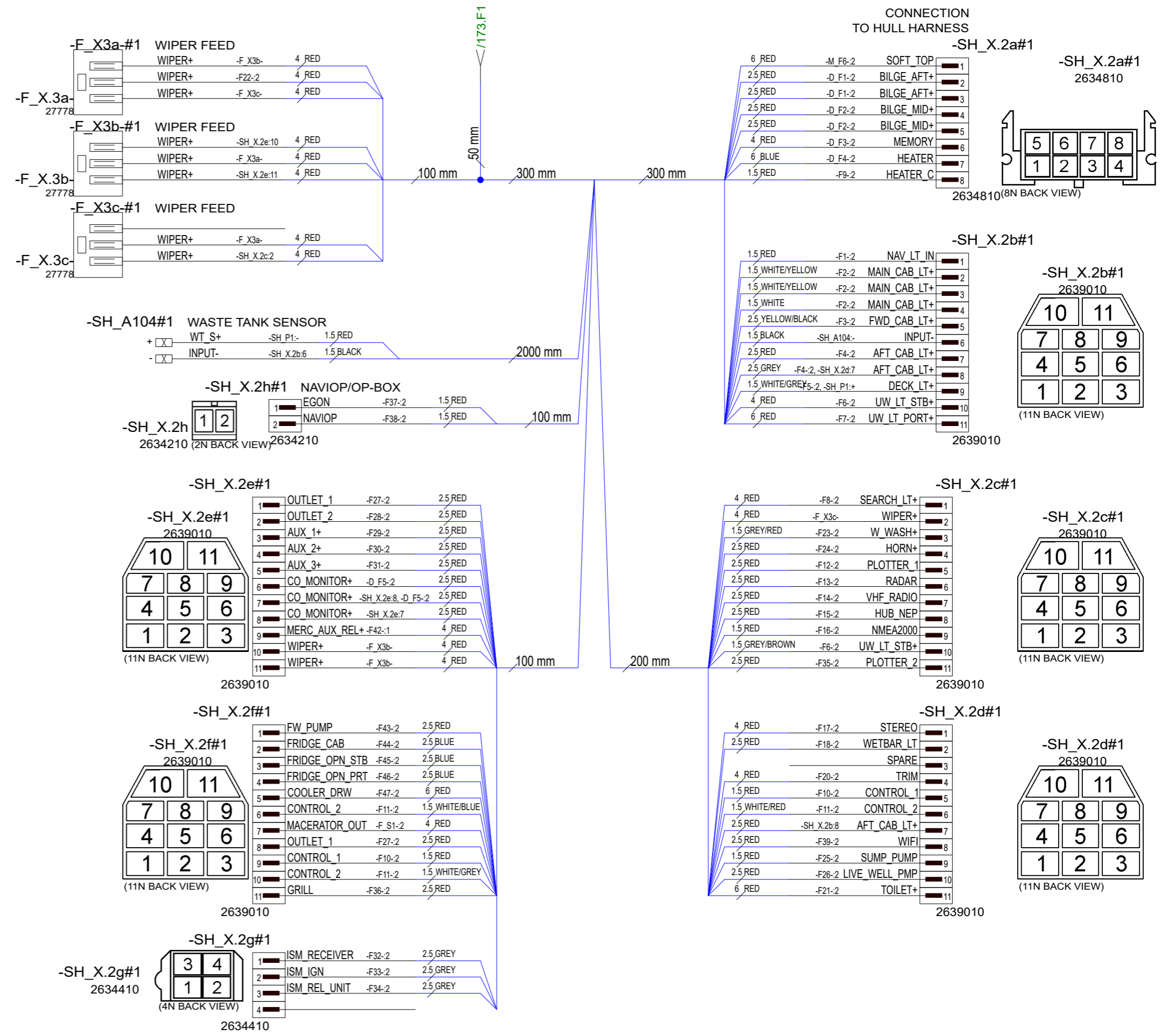

NOTICE!
 VERIFY THAT ALL CABLES HAVE MARKINGS SHOWN IN EXAMPLE BELOW.
 EXEMPTION:
 ALL <500mm WIRES AND BLACK WIRES THIS MARKING IS NOT NEEDED.

EXAMPLE: RED 1,5mm² WIRE MARKINGS.

23.11.2023	PF	F10: 2004954; Changed livewell fuse to 3A	Date	24.4.2020		Axopar	SEE EXP VIEW	30811	Project ID			
13.4.2024	PF	G11: 2005054; F47 10A->16A	Drawing by	TuM		Boat				37 MY20 SHADOW	FUSE UNIT	HL
17.2.2023	RK	F9: -F18 NOW USED FOR WETBAR LT	Sheet rev.	11		Boat model					Title	Loc
Date of modification	Modified by	Description	Project rev.	G	Copyright by				Sheet			

FUSE PANEL GENERAL LAYOUT/ LABELS

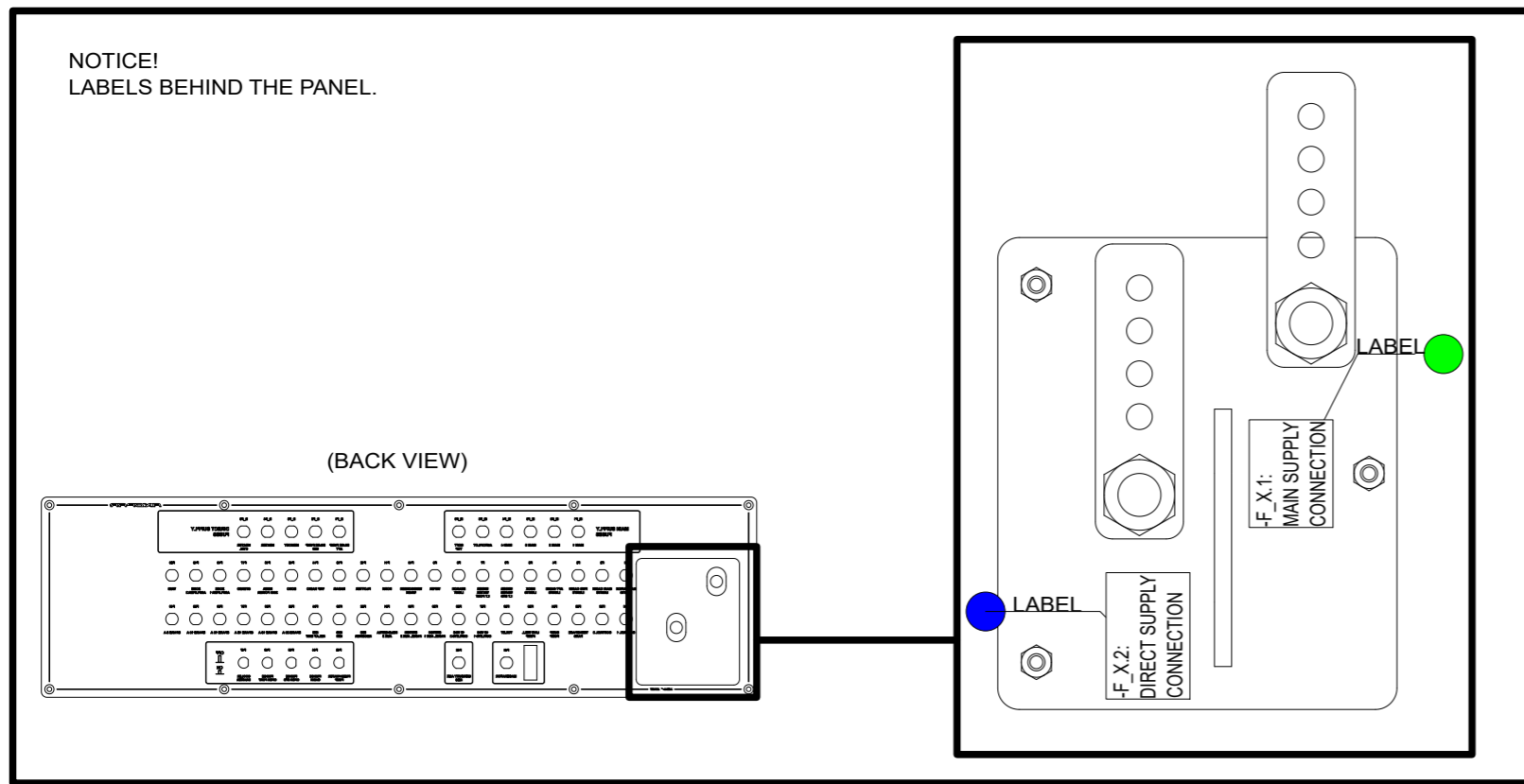
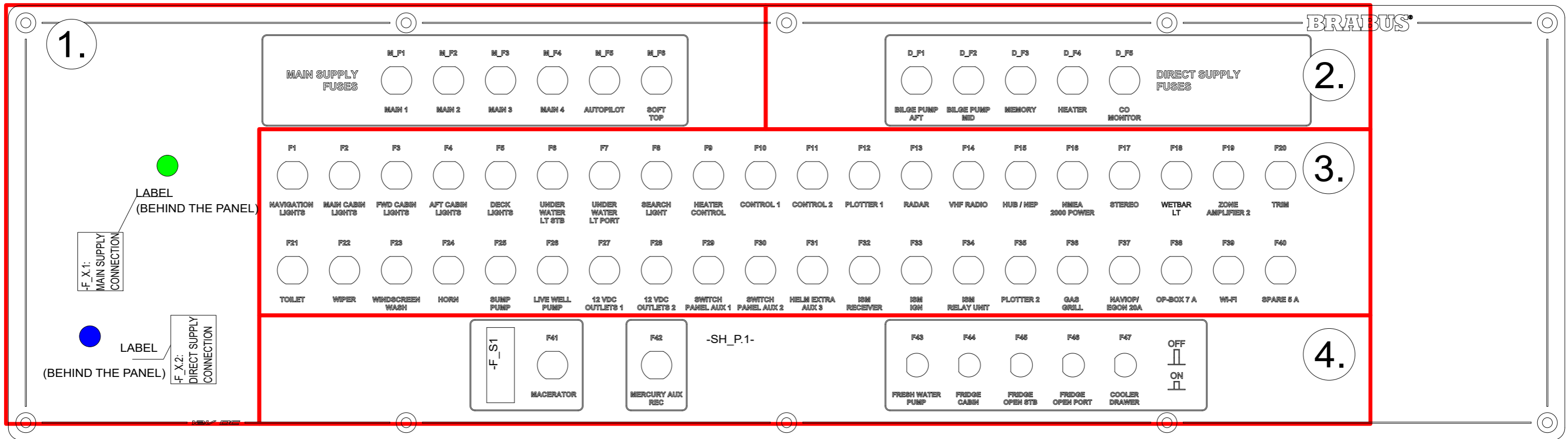

23.11.2023	PF	F10: 2004954; Changed livewell fuse to 3A	Date	24.4.2020	NAVIX designed solutions	Axopar	SEE EXP VIEW	30811	Project ID
13.4.2024	PF	G11: 2005054; F47 10A->16A	Drawing by	TuM		Boat	Sub-product code	Product code	
17.2.2023	RK	F9: -F18 NOW USED FOR WETBAR LT	Sheet rev.	11	Copyright by	37 MY20 SHADOW	FUSE UNIT	HL	176 / 213 Sheet
Date of modification	Modified by	Description	Project rev.	G	Boat model	Title	Loc		

30811_AXOPAR_37_MY_20_SHADOW_FUSE_UNIT

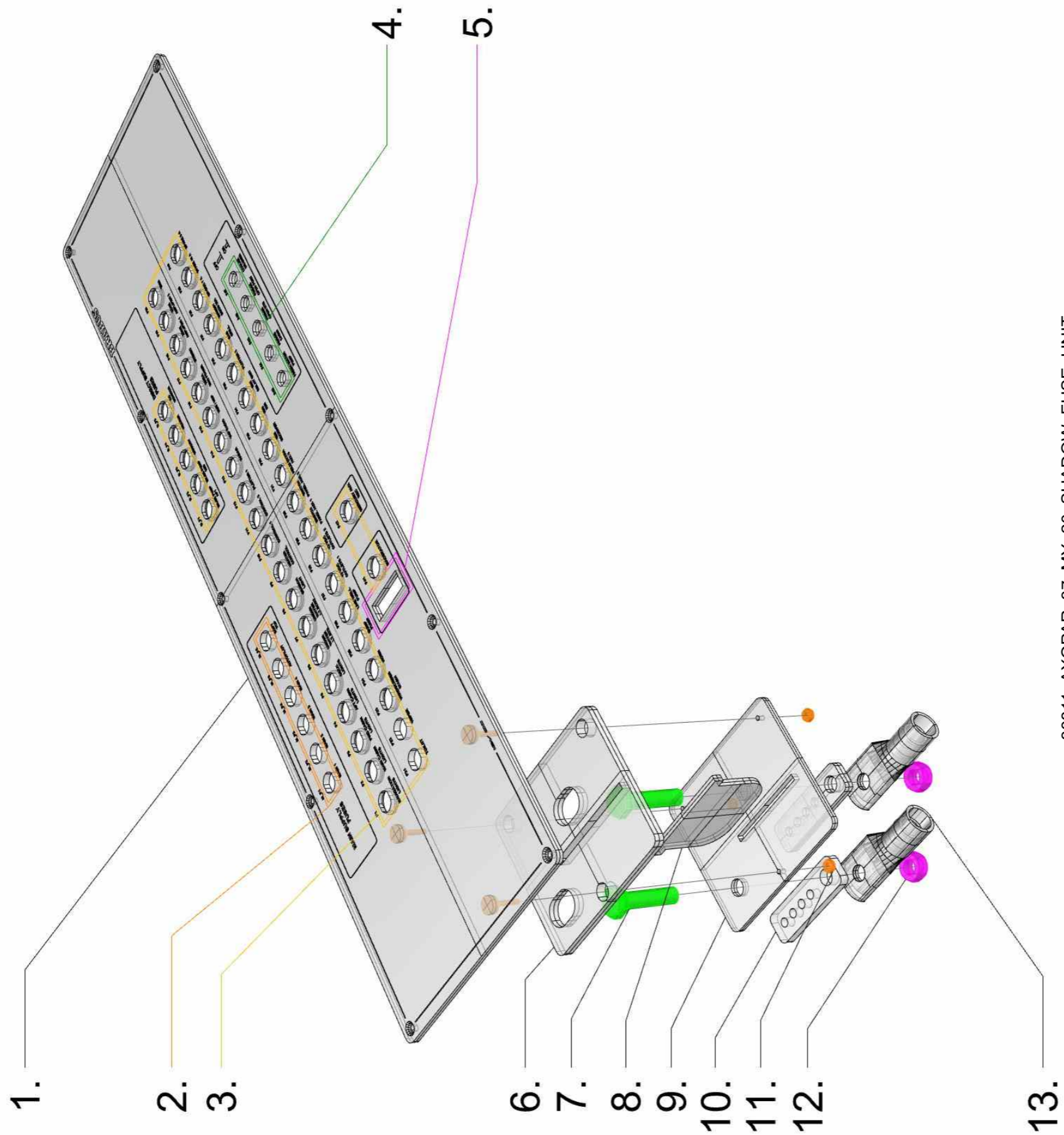

30811_AXOPAR_37_MY_20_SHADOW_FUSE_UNIT

- 1. 1PC 31116_AXOPAR_37_MY_20_SHADOW_FUSE_UNIT_PANEL_(WOC)_V5
- 2. 6PCS KUOYUH_98H_SERIES
- 3. 47PCS KUOYUH_98_SERIES
- 4. 5PCS ETA 1140 FUSE
- 5. 1PC ARCOLECTRIC_15...B_33.4X14.0
- 6. 1PC 29918_AXOPAR_37_MY20_FUSE_UNIT_MS_DC_BTM_PANEL_(WOC)
- 7. 2PCS M10 L40
- 8. 1PC 29920_AXOPAR_37_MY20_FUSE_UNIT_MS_DC_SPACER_PANEL_(WOC)
- 9. 1PC 29919_AXOPAR_37_MY20_FUSE_UNIT_MS_DC_TOP_PANEL_(WOC)
- 10. 2PCS 30167_NAVIX_LINE_VIRTAKISKO_FOUR_SPOT_SMALL
- 11. 3PCS M4 NUT A4
- 12. 2PCS M10 SPRING WASHER
2PCS M10 NUT A4
- 13. 2PCS CABLE SHOES (AS IN DIAGRAM)

TE 30.10.2019
TS 21.06.2021

EXP VIEW

23.11.2023	PF	F10: 2004954; Changed livewell fuse to 3A	Date	24.4.2020		Axopar	SEE EXP VIEW	30811	Project ID
13.4.2024	PF	G11: 2005054; F47 10A->16A	Drawing by	TuM		Boat	Sub-product code	Product code	
17.2.2023	RK	F9: -F18 NOW USED FOR WETBAR LT	Sheet rev.	11		37 MY20 SHADOW	FUSE UNIT	HL	177 / 213 Sheet
Date of modification	Modified by	Description	Project rev.	G	Boat model	Title	Loc		

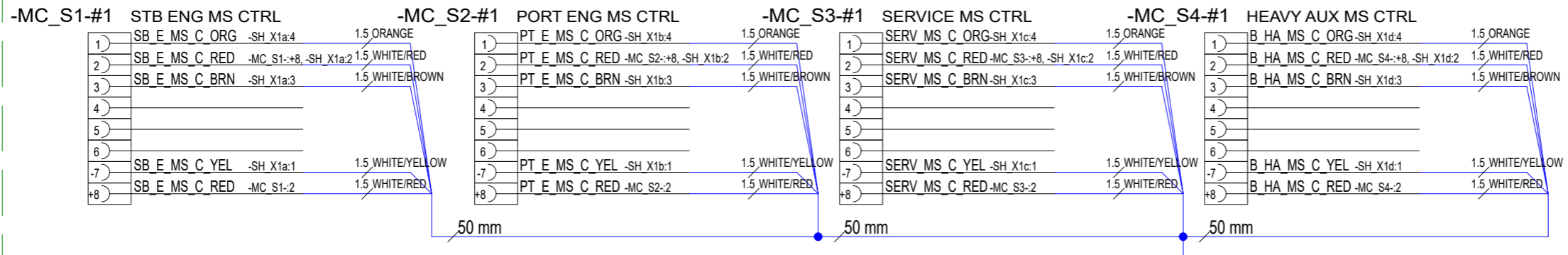
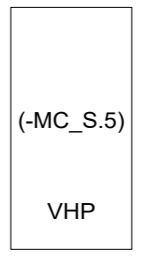
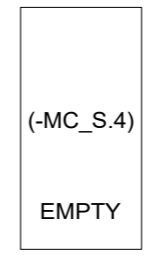
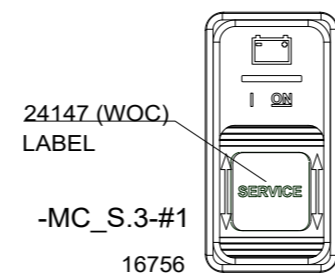
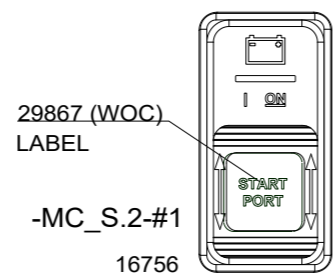
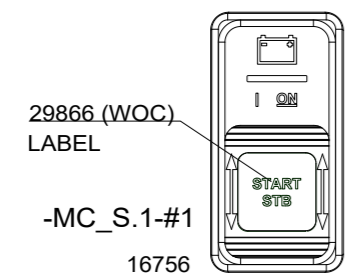
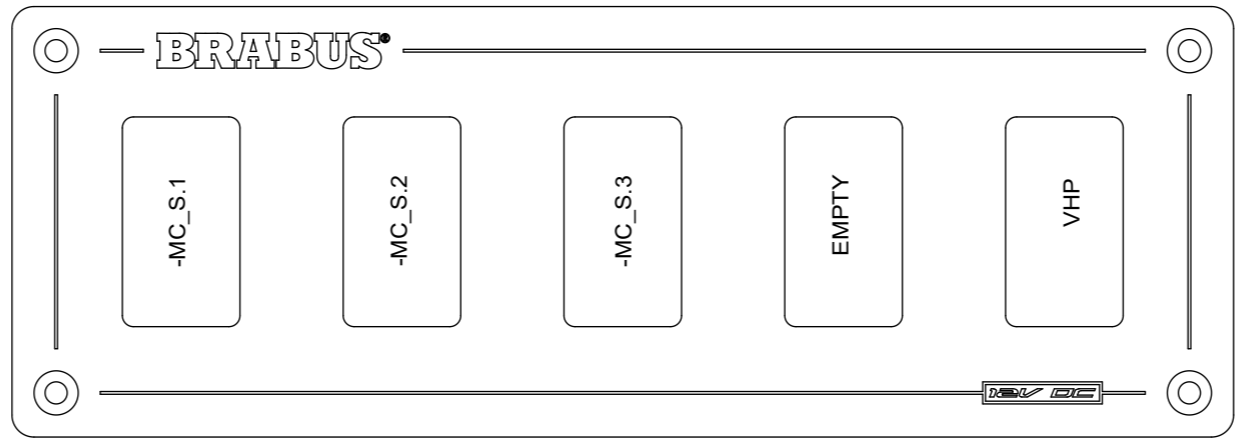

CONNECTION TO DECK HARNESS: X.1 CONNECTORS

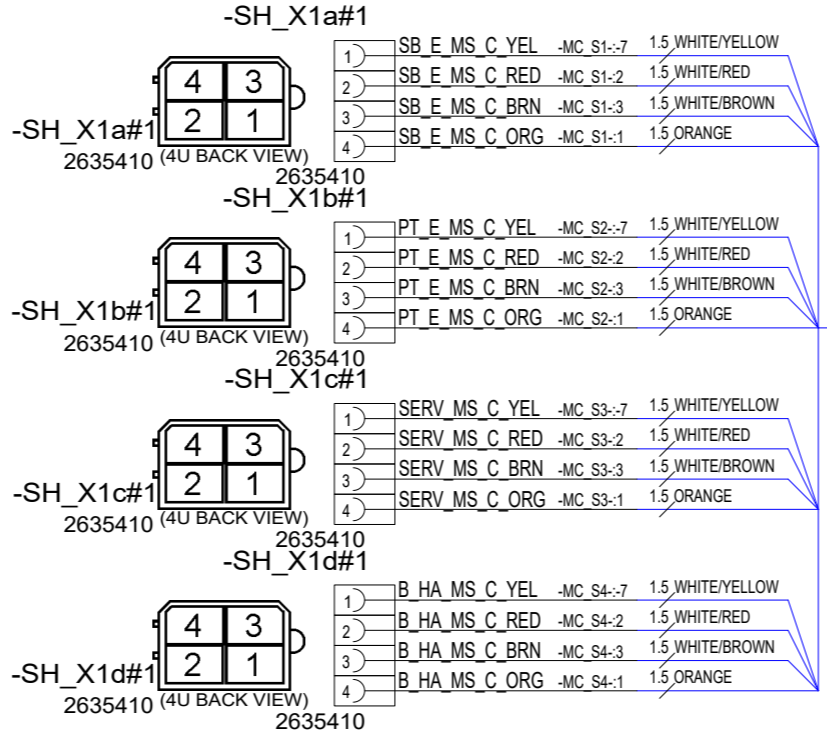

NOTICE!
 VERIFY THAT ALL CABLES HAVE MARKINGS SHOWN IN EXAMPLE BELOW.
 EXEMPTION:
 ALL <500mm WIRES AND BLACK WIRES THIS MARKING IS NOT NEEDED.

EXAMPLE: RED 1,5mm² WIRE MARKINGS.

19.4.2024	PF	G4: 2005054; Not modified	Date	6.11.2019		Axopar	31120	30812	Project ID HL Loc	178 / 213 Sheet
22.9.2021	VV	E4: NOT MODIFIED / REVISION RETURNED TO REV. E.	Drawing by	TuM		Boat	Sub-product code	Product code		
17.2.2023	RK	F4: NOT MODIFIED.	Sheet rev.	4		37 MY20 SHADOW	MAIN SWITCH CONTROL PANEL			
Date of modification	Modified by	Description	Project rev.	G		Boat model	Title			

NOTICE! CABLES WITH STICKER

FOR EXAMPLE
HEAVY AMP: POWER+



LABEL
POWER STEER 1. CABLES

(TO TOP OF PACKAGE)

OPTION 1.
-TWIN ENGINE ONE STEERING PUMP

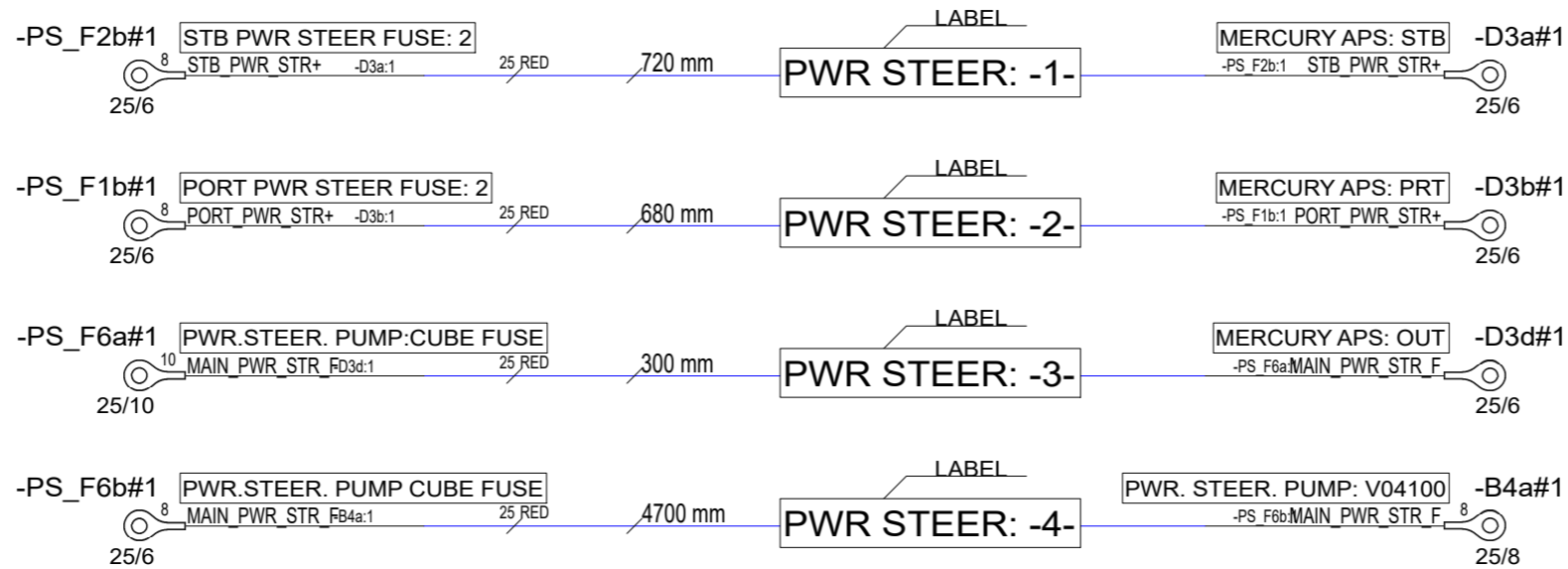

PACKED TO OWN PACKAGE.

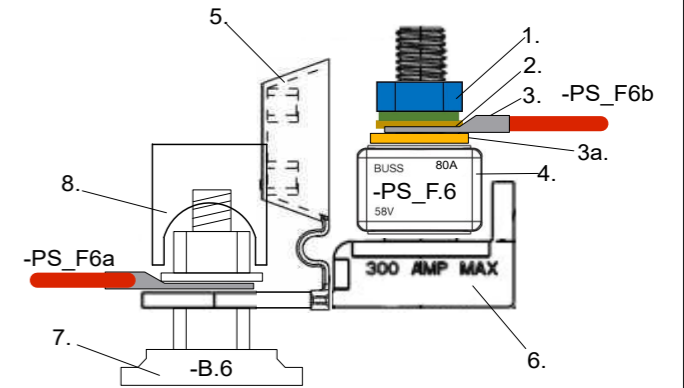

TERMINAL FUSE BLOCK

1. VMI36860 HEX NUT 1/4" "UNC A4
2. VMI31830 SPRING LOCK WASHER M6 DIN127
3. VMI31831 FLAT WASHER FOR hex BOLTS AND NUTS M6 DIN125A
- 3a. VMI36859 WIDE FLAT WASHER FOR HEX BOLT AND NUTS M6 A4 DIN9021
4. 34640 -PS_F.6 CUBE FUSE MRFB-080 80A
5. 34641 -B.6 CFCOVER-1R SINGLE STUD/RED
6. 34642 CFBAR1-250SP SINGLE STUD
7. 36213 POWER DISTRIBUTION STUD IS-10mm-1R
8. 31588 INSULATED COVER POSITIVE RED ISC-10R

NOTICE!
BATTERY CABLES NEED TO ADD MARKINGS SHOWN IN EXAMPLE BELOW.

EXEMPTION:
ALL BLACK WIRES
THIS MARKING IS NOT NEEDED.

R2 ISO 6722 100V AWG6 +100 C

EXAMPLE: RED 16mm2 WIRE MARKINGS.

MARKING SHOWN ABOVE ONLY TO CABLES LISTED BELOW.

EQUIVALENCY:

mm2	=	AWG
10 mm2	=	AWG8
16 mm2	=	AWG6
25 mm2	=	AWG3
35 mm2	=	AWG2

LOOK FOR EQUIVALENT AWG SIZE FOR mm2 AND ADD THIS TO CABLE MARKINGS.

FOR EXAMPLE:
CABLE SIZE IS 25mm2 --> MARKING AWG3.

17.2.2023	RK	F3: NOT MODIFIED.	Date	5.7.2019
19.4.2024	PF	G3: 2005054; Not modified	Drawing by	TuM
1.12.2021	PN	E3: ADDED -PS_F.6, B.6, FUSE HOLDER & CABLE -PS_F6a_-D3d	Sheet rev.	3
Date of modification	Modified by	Description	Project rev.	G

NAVIX
designed solutions

Copyright by

Axopar

Boat
37 MY20

Boat model

Sub-product code
**POWER STEERING
CABLES 1xPUMP**
Title

30880
Product code

HL
Loc

Project ID

179 / 213
Sheet

NOTICE! CABLES WITH STICKER

FOR EXAMPLE
HEAVY AMP: POWER+



OPTION 2.
-TWIN EMGINE, TWIN STEERING PUMP

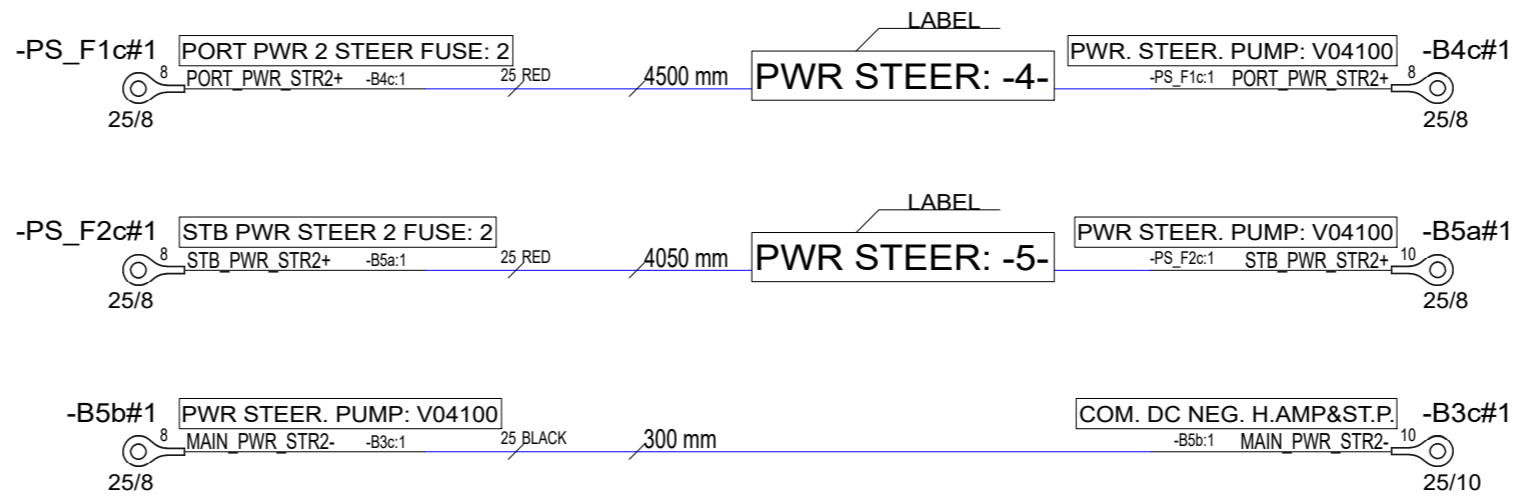

LABEL
POWER STEER 2. CABLES
(TO TOP OF PACKAGE)

INCLUDED

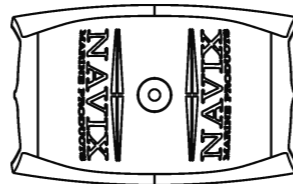

-B.5#1
V4100

PACKED TO OWN PACKAGE.

NOTICE!
BATTERY CABLES NEED TO ADD MARKINGS
SHOWN IN EXAMPLE BELOW.

EXEMPTION:
ALL BLACK WIRES
THIS MARKING IS NOT NEEDED.

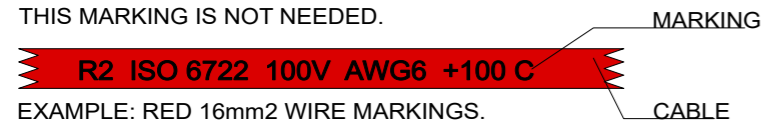

EXAMPLE: RED 16mm2 WIRE MARKINGS.

MARKING SHOWN ABOVE ONLY TO CABLES LISTED BELOW.

EQUIVALENCY:

mm2	=	AWG
10 mm2	=	AWG8
16 mm2	=	AWG6
25 mm2	=	AWG3
35 mm2	=	AWG2

LOOK FOR EQUIVALENT AWG SIZE FOR mm2
AND ADD THIS TO CABLE MARKINGS.

FOR EXAMPLE:
CABLE SIZE IS 25mm2 --> MARKING AWG3.

19.4.2024	PF	G3: 2005054; Not modified	Date	5.7.2019		Axopar			
22.9.2021	VV	E3: NOT MODIFIED / REVISION RETURNED TO REV. E.	Drawing by	TuM		Boat		30881	
17.2.2023	RK	F3: NOT MODIFIED.	Sheet rev.	3		37 MY20	Sub-product code	Product code	Project ID
Date of modification	Modified by	Description	Project rev.	G		Boat model	POWER STEERING CABLES 2xPUMP	HL	180 / 213
						Title	Loc	Sheet	

NOTICE!
 VERIFY THAT ALL CABLES HAVE MARKINGS
 SHOWN IN EXAMPLE BELOW.
 EXEMPTION:
 ALL <500mm WIRES AND BLACK WIRES
 THIS MARKING IS NOT NEEDED.

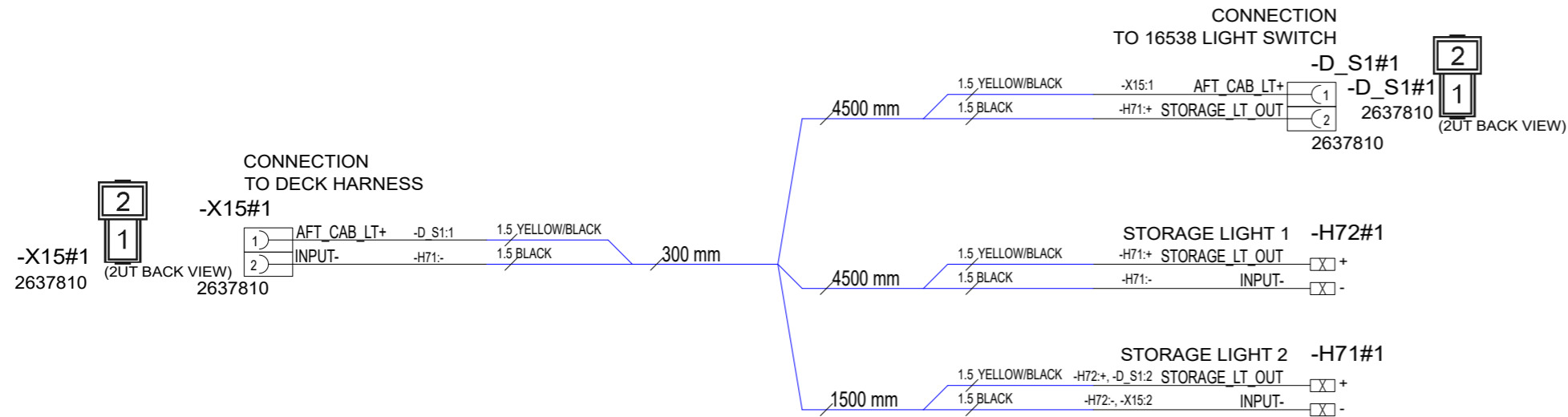
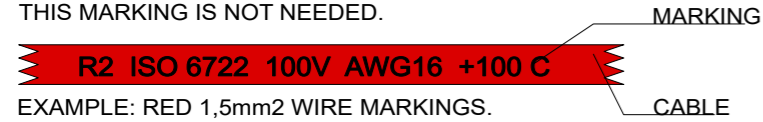

22.9.2021	VV	E2: NOT MODIFIED / REVISION RETURNED TO REV. E.	Date	2.4.2020		Axopar			
17.2.2023	RK	F2: NOT MODIFIED.	Drawing by	TuM		Boat		32118	
19.4.2024	PF	G2: 2005054; Not modified	Sheet rev.	2		37 MY20	MULTISTORAGE LT HARNESS	HL	181/ 213
Date of modification	Modified by	Description	Project rev.	G		Boat model	Title	Loc	Sheet

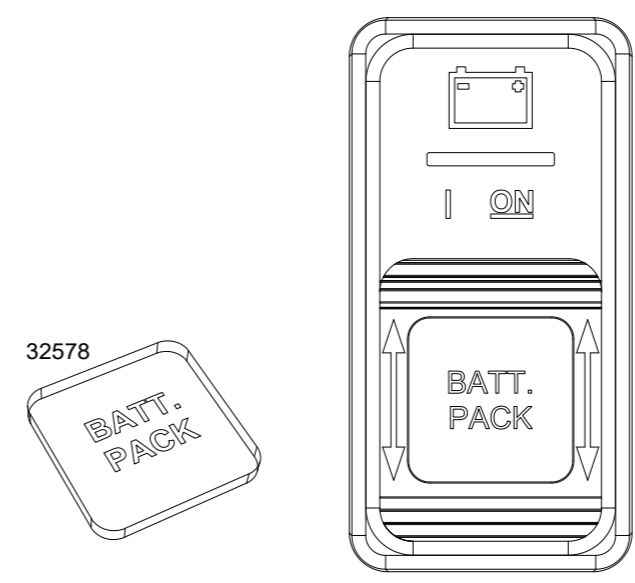

32578 NAVIX LINE BATT.BACK LABEL FOR 16756 SPDT V1
16756 Switch Contura SPDT (ON)OFF(OFF) RG Blue Sea 2145B

NOTICE! WITHOUT THE WIRING HARNESS!



22.9.2021	VV	E3: NOT MODIFIED / REVISION RETURNED TO REV. E.	Date	15.04.2021	NAVIX designed solutions	Axopar	32578	32529	
17.2.2023	RK	F3: NOT MODIFIED.	Drawing by	AR	Boat	37 MY20 SHADOW	Sub-product code	Product code	Project ID
19.4.2024	PF	G3: 2005054; Not modified	Sheet rev.	3	Boat model		BATT.PACK MAIN SWITCH PANEL		HL
Date of modification	Modified by	Description	Project rev.	G					Loc

NOTICE!
BATTERY CABLES NEED TO ADD MARKINGS
SHOWN IN EXAMPLE BELOW.

EXEMPTION:
ALL BLACK WIRES
THIS MARKING IS NOT NEEDED.

R2 ISO 6722 100V AWG6 +100 C
EXAMPLE: RED 16mm2 WIRE MARKINGS.

MARKING SHOWN ABOVE ONLY TO CABLES LISTED BELOW.

LOOK FOR EQUIVALENT AWG SIZE FOR mm2
AND ADD THIS TO CABLE MARKINGS.

FOR EXAMPLE:
CABLE SIZE IS 25mm2 --> MARKING AWG3.

EQUIVALENCY:	
mm2	AWG
10 mm2	= AWG8
16 mm2	= AWG6
25 mm2	= AWG3
35 mm2	= AWG2

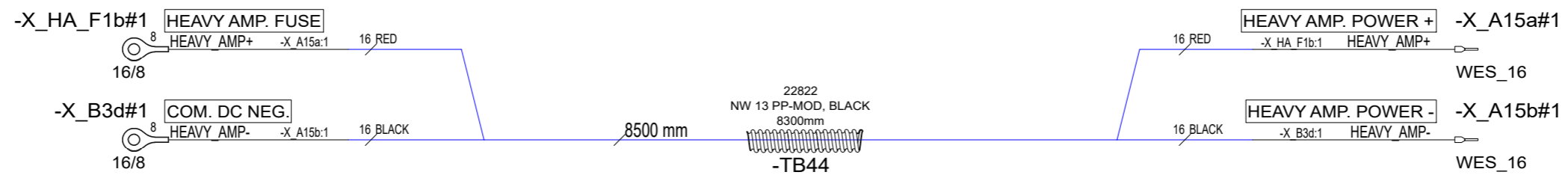
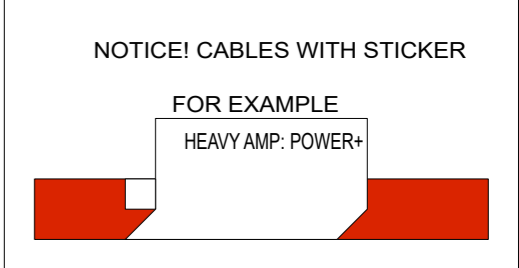

17.2.2023	RK	F2: NOT MODIFIED.
19.4.2024	PF	G2: 2005054; Not modified
22.9.2021	VV	E2: NOT MODIFIED / REVISION RETURNED TO REV. E.
Date of modification	Modified by	Description

Date	5.11.2020
Drawing by	TT
Sheet rev.	2
Project rev.	G



Axopar	33378	Project ID
Boat	Sub-product code	Product code
37 MY20	AMPLIFER POWER CABLE	HL
Boat model	Title	Loc
		183 / 213 Sheet

NOTICE!
 VERIFY THAT ALL CABLES HAVE MARKINGS
 SHOWN IN EXAMPLE BELOW.
 EXEMPTION:
 ALL <500mm WIRES AND BLACK WIRES
 THIS MARKING IS NOT NEEDED.

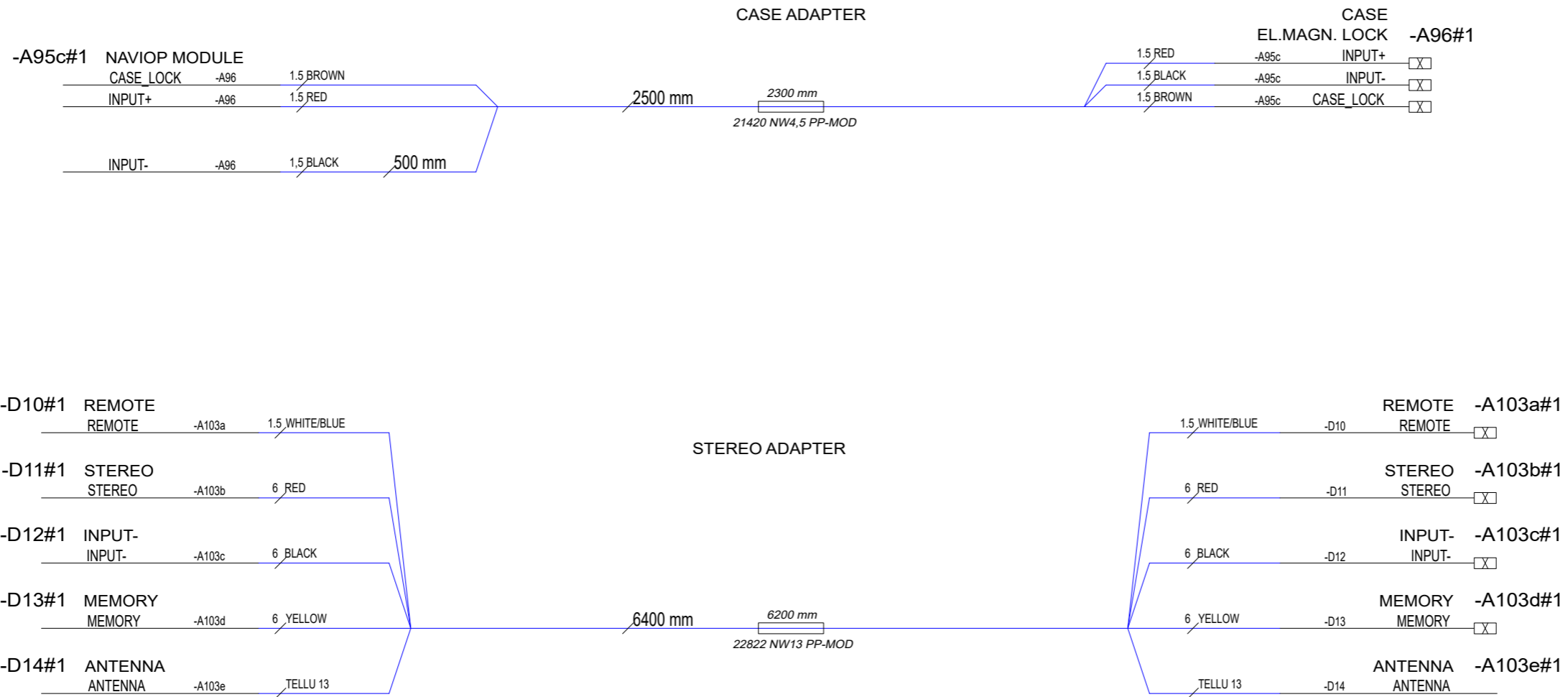
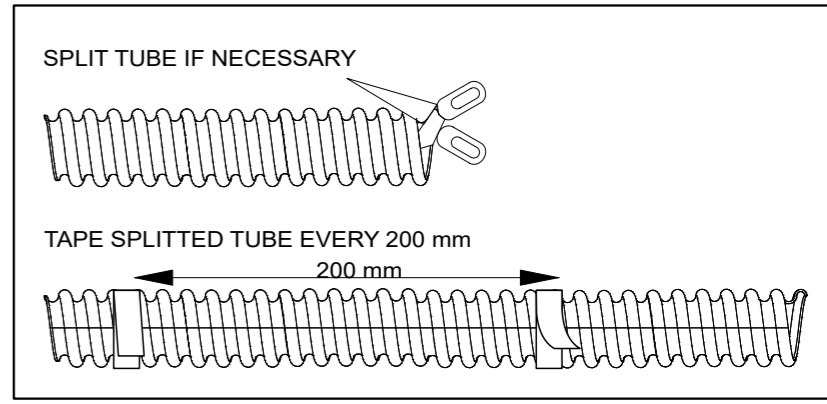

17.2.2023	RK	F2: NOT MODIFIED.	Date	5.11.2020		Axopar		33379	
19.4.2024	PF	G2: 2005054; Not modified	Drawing by	TT		Boat		Product code	Project ID
22.9.2021	VV	E2: NOT MODIFIED / REVISION RETURNED TO REV. E.	Sheet rev.	2		37 MY20 SHADOW	CASE+STEREO+FR CAB. FL LT	HL	184 / 213
Date of modification	Modified by	Description	Project rev.	G		Boat model	Title	Loc	Sheet

NOTICE!
 VERIFY THAT ALL CABLES HAVE MARKINGS
 SHOWN IN EXAMPLE BELOW.
 EXEMPTION:
 ALL <500mm WIRES AND BLACK WIRES
 THIS MARKING IS NOT NEEDED.

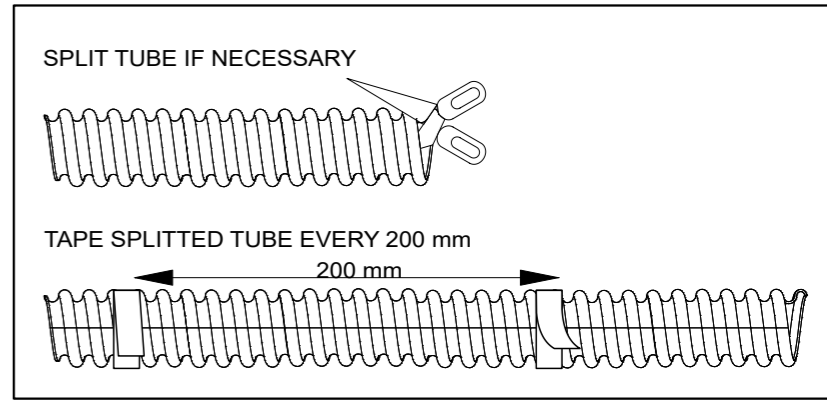

TO DISTRIBUTION

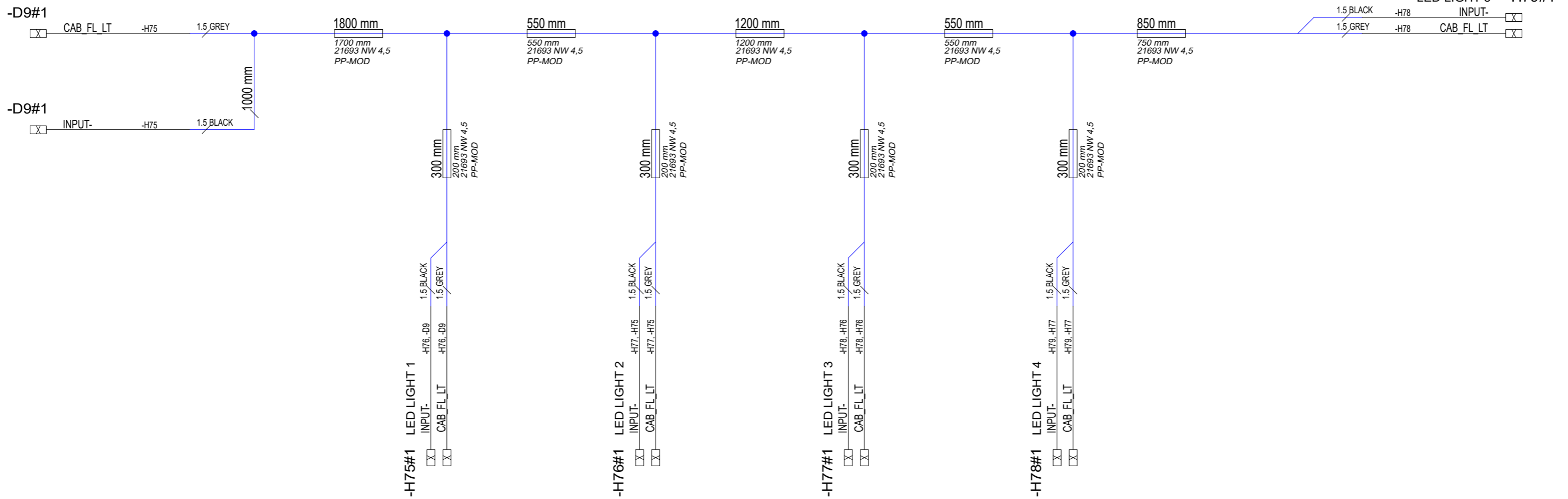

17.2.2023	RK	F2: NOT MODIFIED.	Date	5.11.2020
19.4.2024	PF	G2: 2005054; Not modified	Drawing by	TT
22.9.2021	VV	E2: NOT MODIFIED / REVISION RETURNED TO REV. E.	Sheet rev.	2
Date of modification	Modified by	Description	Project rev.	G



Axopar	33379	Project ID
Boat	Sub-product code	Product code
37 MY20 SHADOW	CASE+STEREO+FR CAB. FL LT	HL
Boat model	Title	Loc
		185 / 213 Sheet

1.

-F_X1
MAIN SUPPLY CONNECTION
COPPER BAR

-F_X2
DIRECT SUPPLY CONNECTION
COPPER BAR

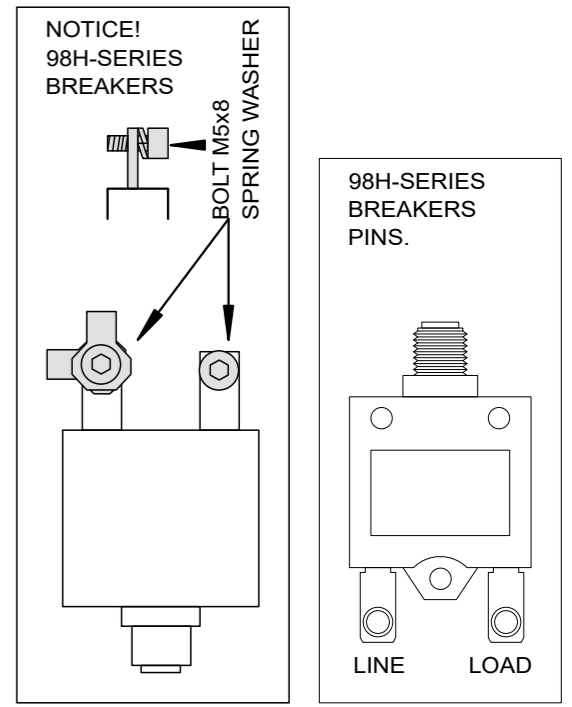
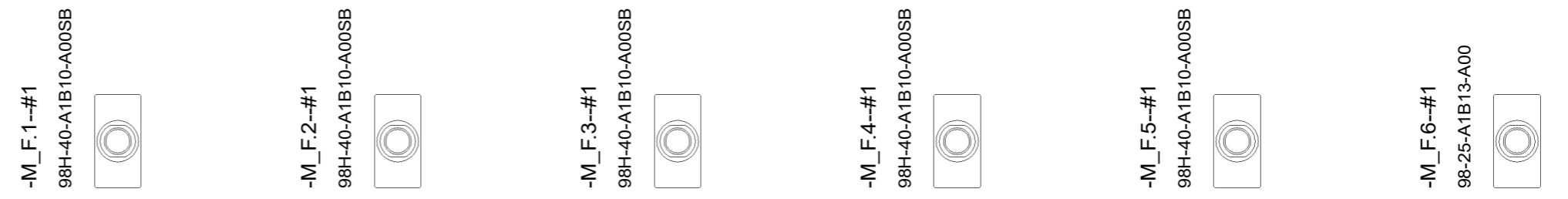
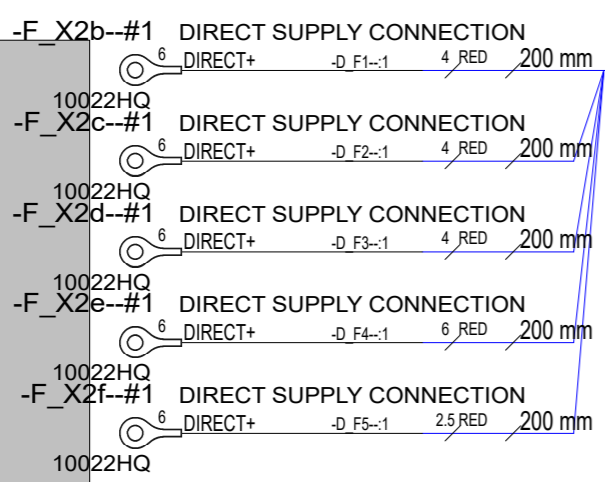
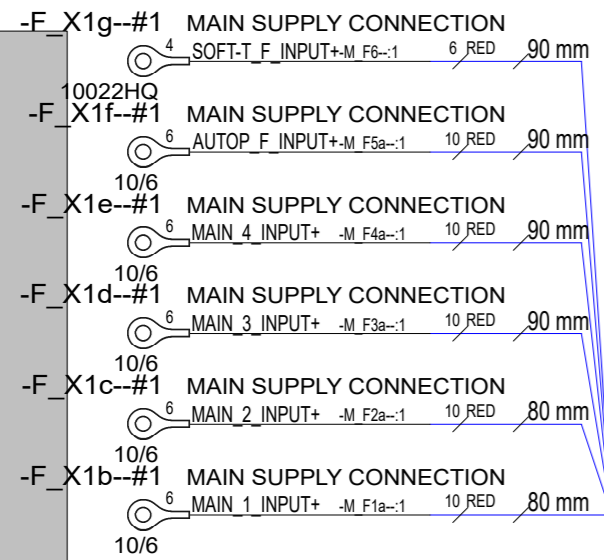

17.2.2023	RK	F3: -F18 IS NOW IN USE FOR WETBAR LT	Date	21.05.2021
23.11.2023	PF	F4: 2004954; Changed livewell fuse to 3A	Drawing by	TT
13.4.2024	PF	G5: 2005054; F47 10A->16A	Sheet rev.	5
Date of modification	Modified by	Description	Project rev.	G



Axopar
Boat
37 MY20 SHADOW
Boat model

SEE EXP VIEW	34828	Project ID
Sub-product code	Product code	
FUSE UNIT EU	HL	186 / 213
Title	Loc	

2.

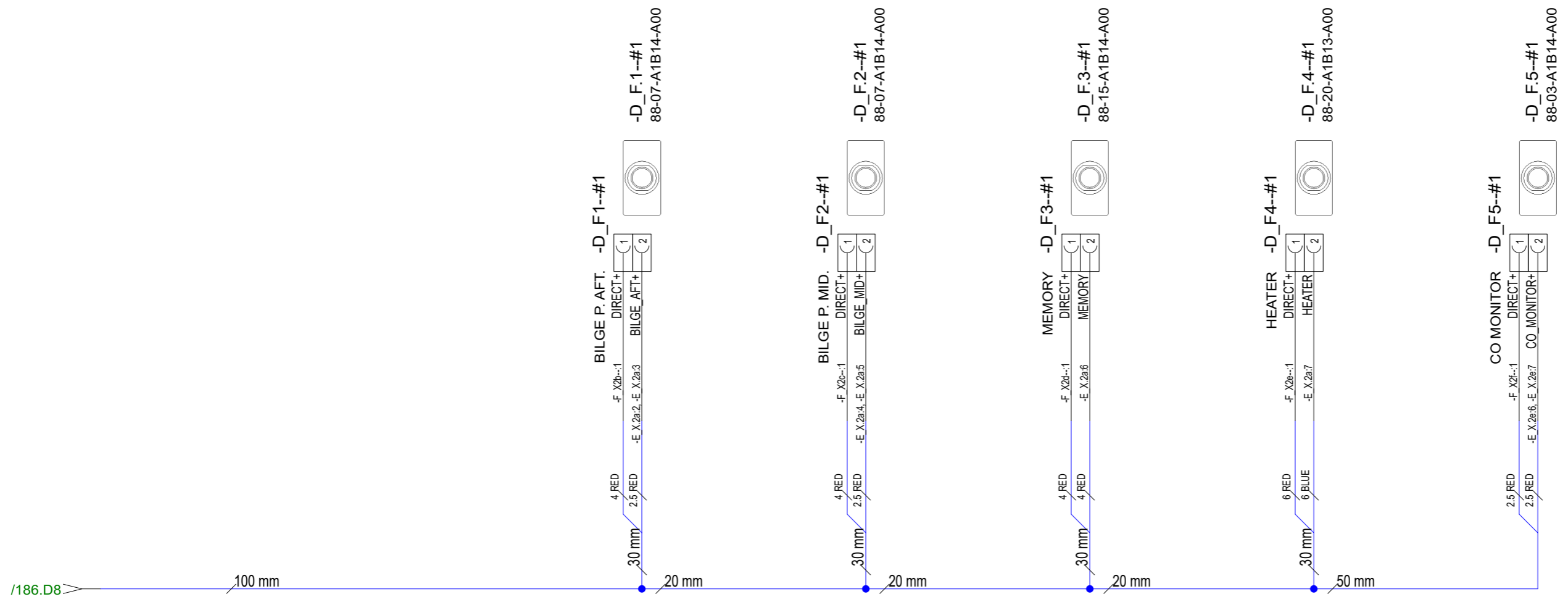

17.2.2023	RK	F3: -F18 IS NOW IN USE FOR WETBAR LT	Date	21.05.2021		Axopar	SEE EXP VIEW	34828	Project ID
23.11.2023	PF	F4: 2004954; Changed livewell fuse to 3A	Drawing by	TT		Boat	Sub-product code	Product code	
13.4.2024	PF	G5: 2005054; F47 10A->16A	Sheet rev.	5	37 MY20 SHADOW	FUSE UNIT EU	HL	187 / 213	
Date of modification	Modified by	Description	Project rev.	G	Boat model	Title	Loc		Sheet

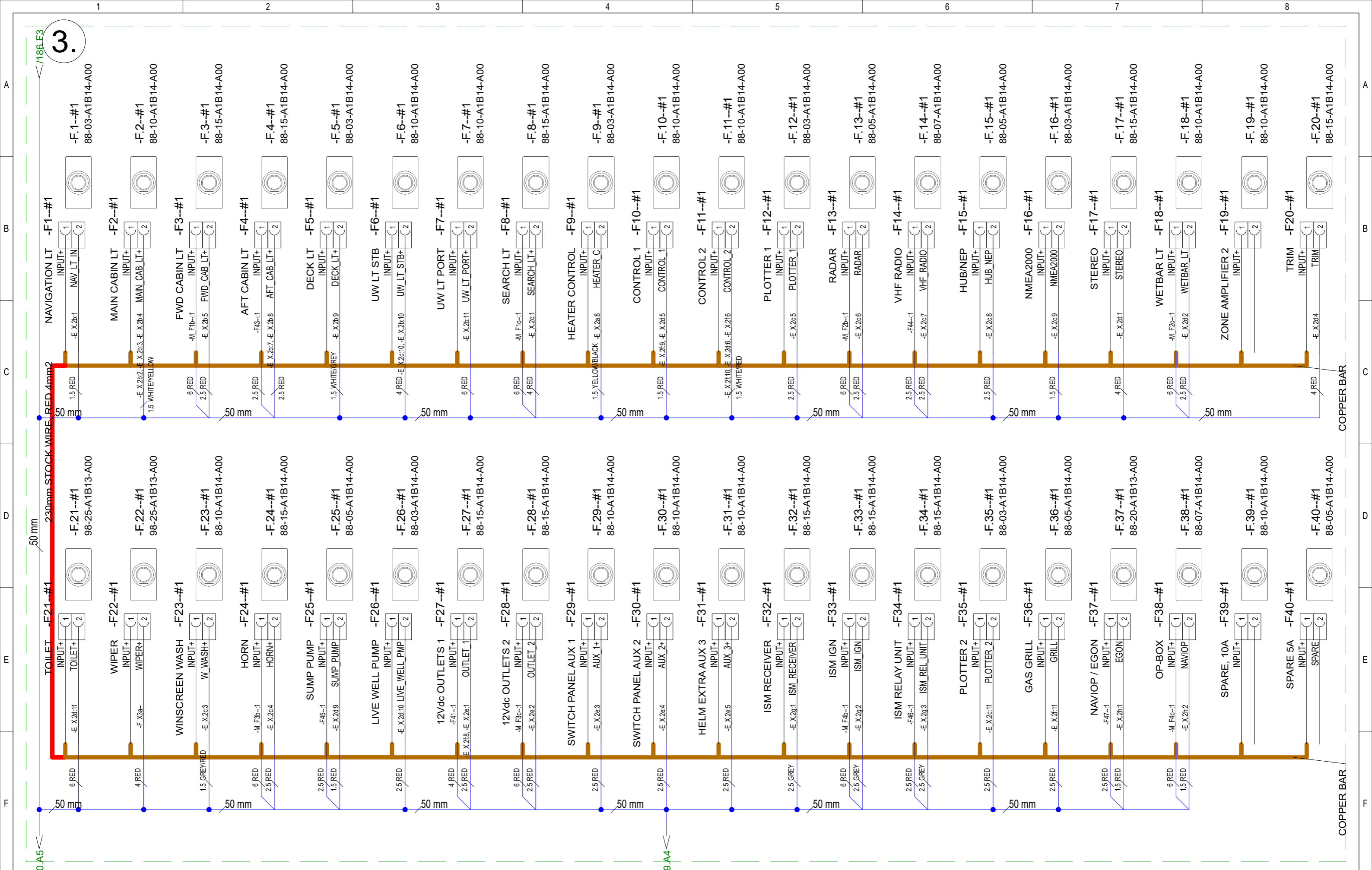

17.2.2023	RK	F3: -F18 IS NOW IN USE FOR WETBAR LT	Date	21.05.2021
23.11.2023	PF	F4: 2004954; Changed livewell fuse to 3A	Drawing by	TT
13.4.2024	PF	G5: 2005054; F47 10A->16A	Sheet rev.	5
Date of modification	Modified by	Description	Project rev.	G



Axopar
Boat
37 MY20 SHADOW
Boat model

SEE EXP VIEW	34828	Project ID
Sub-product code	Product code	
FUSE UNIT EU	HL	188 / 213
Title	Loc	

4.

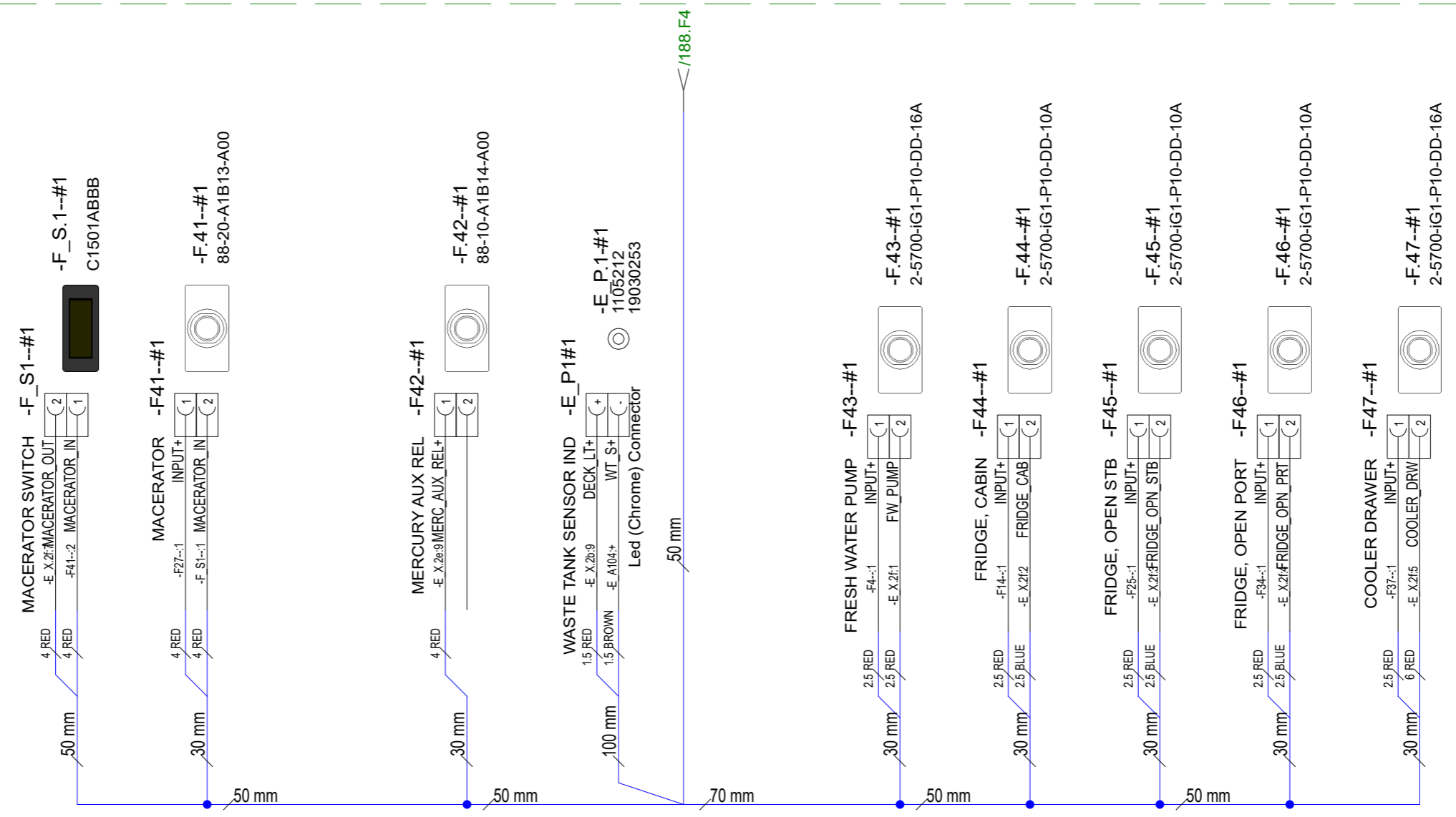

17.2.2023	RK	F3: -F18 IS NOW IN USE FOR WETBAR LT
23.11.2023	PF	F4: 2004954; Changed livewell fuse to 3A
13.4.2024	PF	G5: 2005054; F47 10A->16A
Date of modification	Modified by	Description

Date	21.05.2021
Drawing by	TT
Sheet rev.	5
Project rev.	G



Axopar
Boat
37 MY20 SHADOW
Boat model

SEE EXP VIEW	34828	Project ID
Sub-product code	Product code	
FUSE UNIT EU	HL	189 / 213
Title	Loc	

FUSE PANEL GENERAL LAYOUT/ LABELS

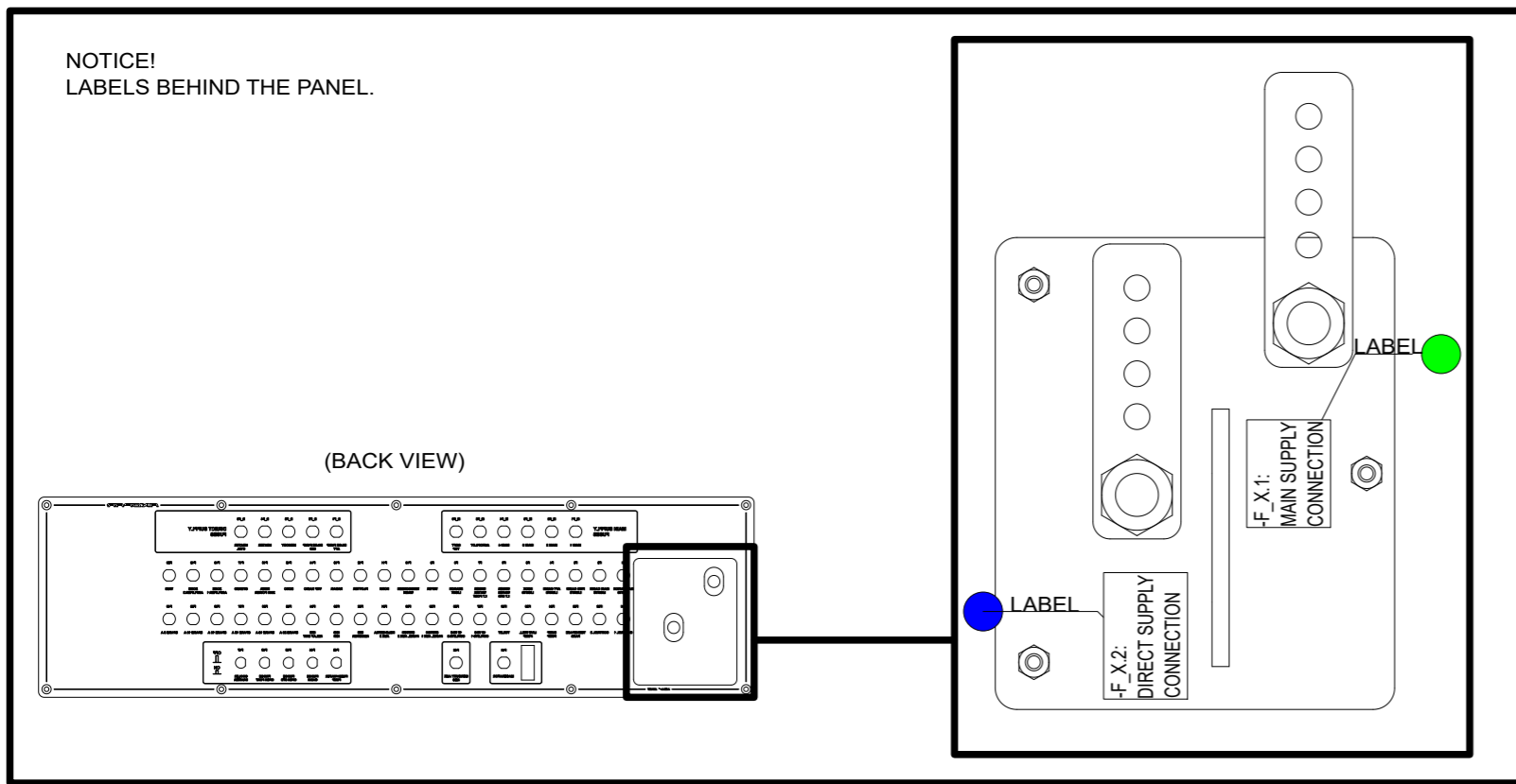
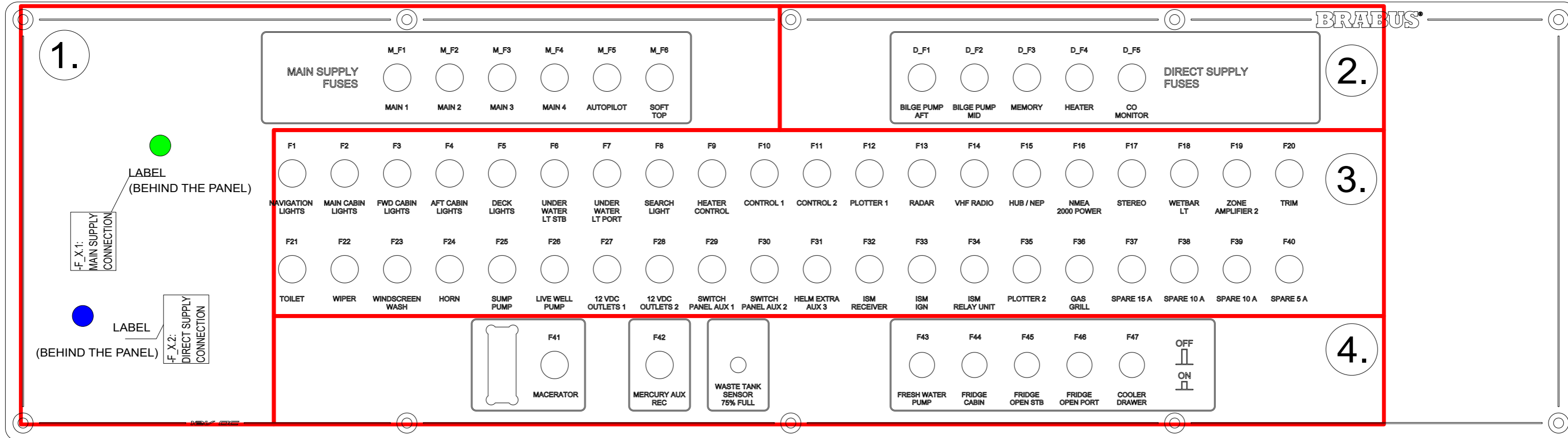

17.2.2023	RK	F3: -F18 IS NOW IN USE FOR WETBAR LT	Date	21.05.2021	NAVIX designed solutions	Axopar	SEE EXP VIEW	34828	Project ID
23.11.2023	PF	F4: 2004954; Changed livewell fuse to 3A	Drawing by	TT		Boat	Sub-product code	Product code	
13.4.2024	PF	G5: 2005054; F47 10A->16A	Sheet rev.	5	Copyright by	37 MY20 SHADOW	FUSE UNIT EU	HL	191/ 213 Sheet
Date of modification	Modified by	Description	Project rev.	G	Boat model	Title	Loc		

34828_AXOPAR_37_SHADOW_FUSE_UNIT_EU

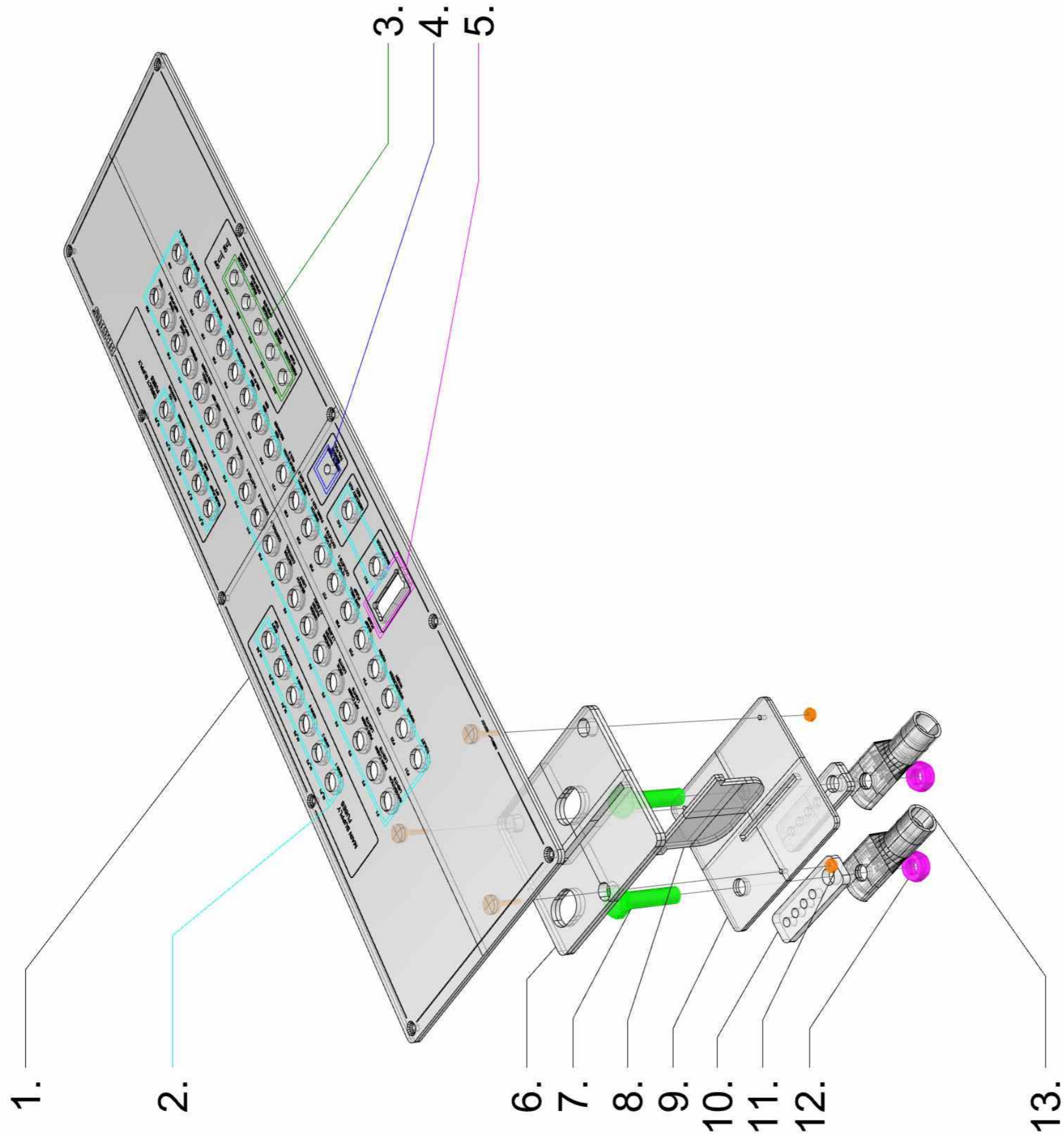

34828_AXOPAR_37_SHADOW_FUSE_UNIT_EU

- 1. 1PC 35001_AXOPAR_37_SHADOW_FUSE_UNIT_EU_PANEL_(WOC)
- 2. 53PCS KUOYUH_98H_SERIES (as in diagram)
- 3. 5PCS ETA 1140 FUSE
- 4. 1PC 19030253 LED PANEL MOUNT INDICATOR, SATIN CHROME BEZEL. RED. 12 VDC, 6mm 20mA, 13MCD, IP40
- 5. 1PC ARCOLLECTRIC_15..B_33.4X14.0
- 6. 1PC 29918_AXOPAR_37_MY20_FUSE_UNIT_MS_DC_BTM_PANEL_(WOC)
- 7. 2PCS M10 L40
- 8. 1PC 29920_AXOPAR_37_MY20_FUSE_UNIT_MS_DC_SPACER_PANEL_(WOC)
- 9. 1PC 29919_AXOPAR_37_MY20_FUSE_UNIT_MS_DC_TOP_PANEL_(WOC)
- 10. 2PCS 30167_NAVIX_LINE_VIRTAKISKO_FOUR_SPOT_SMALL
- 11. 3PCS M4 NUT A4
- 12. 2PCS M10 SPRING WASHER
2PCS M10 NUT A4
- 13. 2PCS CABLE SHOES (AS IN DIAGRAM)

EXP VIEW

TE 19.05.2021

17.2.2023	RK	F3: -F18 IS NOW IN USE FOR WETBAR LT	Date	21.05.2021
23.11.2023	PF	F4: 2004954; Changed livewell fuse to 3A	Drawing by	TT
13.4.2024	PF	G5: 2005054; F47 10A->16A	Sheet rev.	5
Date of modification	Modified by	Description	Project rev.	G



Axopar	SEE EXP VIEW	34828	Project ID
Boat	Sub-product code	Product code	
37 MY20 SHADOW	FUSE UNIT EU	HL	192 / 213 Sheet
Boat model	Title	Loc	

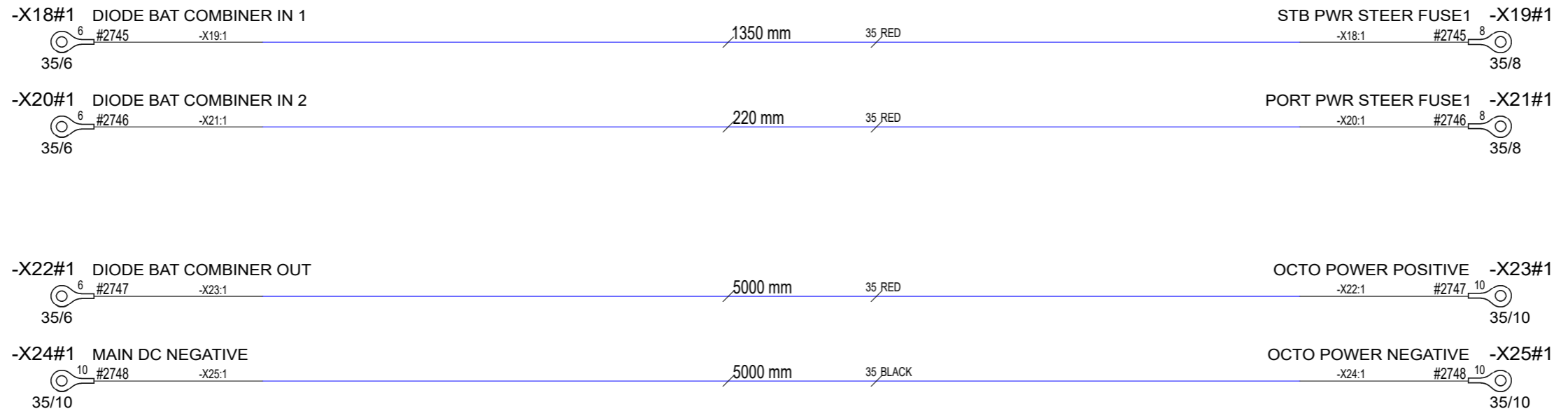
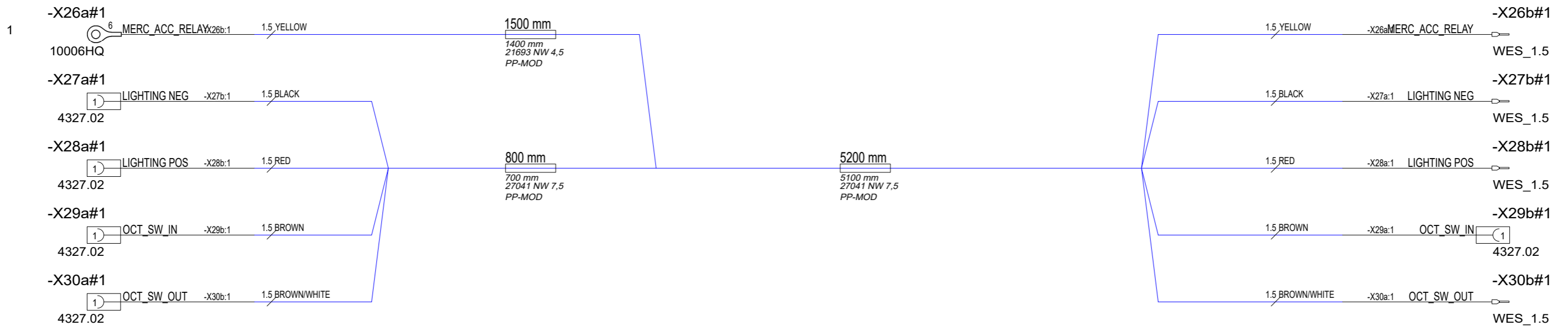

17.2.2023	RK	F1: INTRODUCED DRAWING	Date	13.2.2023		Axopar				
19.4.2024	PF	G1: 2005054; Not modified	Drawing by	RK		Boat	37 MY20 SHADOW	Sub-product code	38424	Project ID
			Sheet rev.	1		Boat model		OCTO POWER HARNESS	HL	193 / 213
Date of modification	Modified by	Description	Project rev.	G	Copyright by		Title	Loc	Sheet	

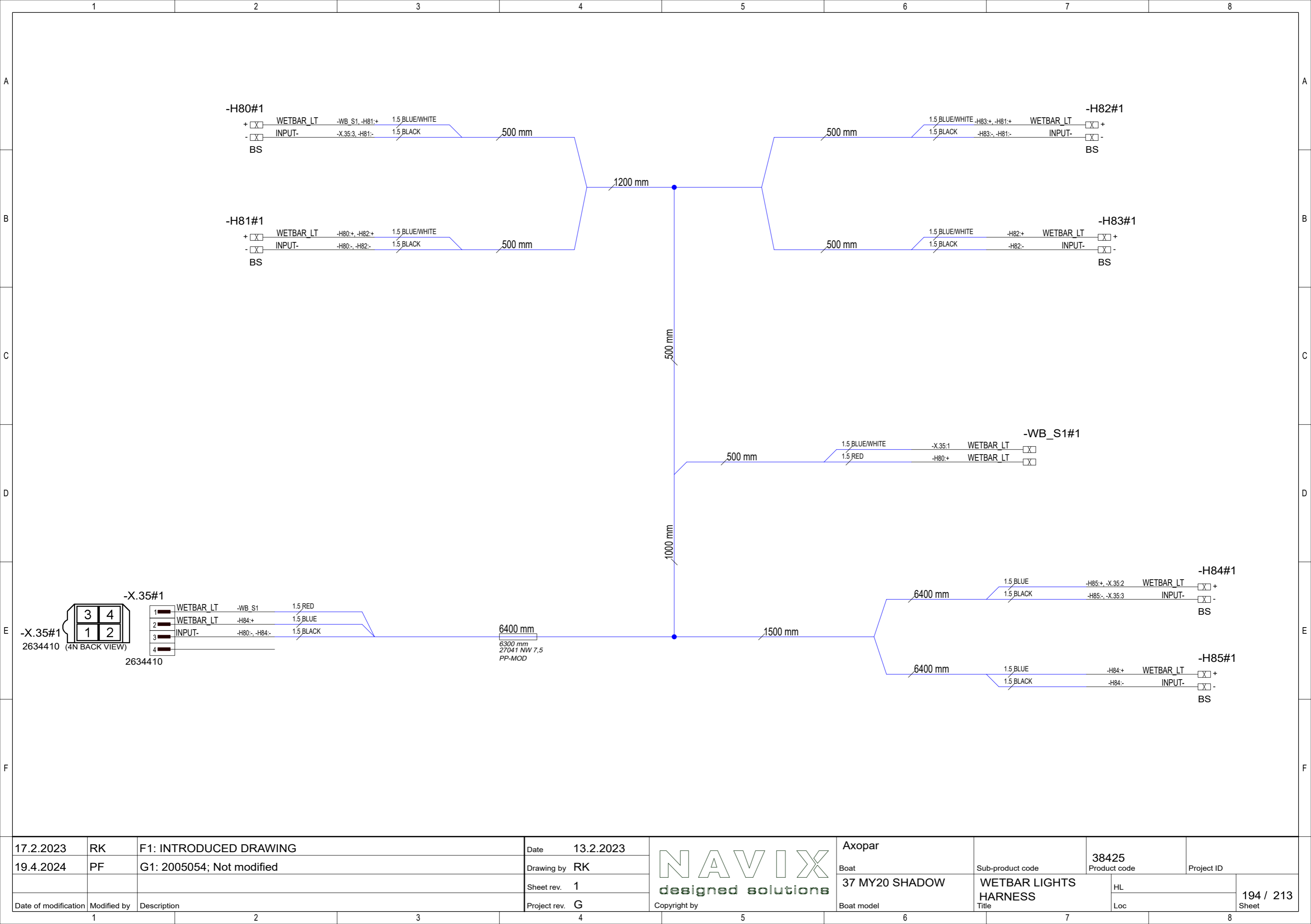

17.2.2023	RK	F1: INTRODUCED DRAWING	Date	13.2.2023
19.4.2024	PF	G1: 2005054; Not modified	Drawing by	RK
			Sheet rev.	1
Date of modification	Modified by	Description	Project rev.	G



Axopar			
Boat	37 MY20 SHADOW	Sub-product code	38425
Boat model		Product code	
		Title	WETBAR LIGHTS HARNESS
		HL	
		Loc	
			194 / 213
			Sheet

NOTICE!
BATTERY CABLES NEED TO ADD MARKINGS
SHOWN IN EXAMPLE BELOW.

EXEMPTION:
ALL BLACK WIRES
THIS MARKING IS NOT NEEDED.

EXAMPLE: RED 50mm² WIRE MARKINGS.

MARKING SHOWN ABOVE ONLY TO CABLES LISTED BELOW.

EQUIVALENCY:	
mm ²	AWG
25 mm ²	= AWG3
35 mm ²	= AWG2
50 mm ²	= AWG0
70 mm ²	= AWG2/0
95 mm ²	= AWG3/0
120 mm ²	= 250 kcmil

LOOK FOR EQUIVALENT AWG SIZE FOR mm²
AND ADD THIS TO CABLE MARKINGS.

FOR EXAMPLE:
CABLE SIZE IS 70mm² --> MARKING AWG2/0.

NOTICE! CABLES WITH STICKER

FOR EXAMPLE
HEAVY AMP: POWER+

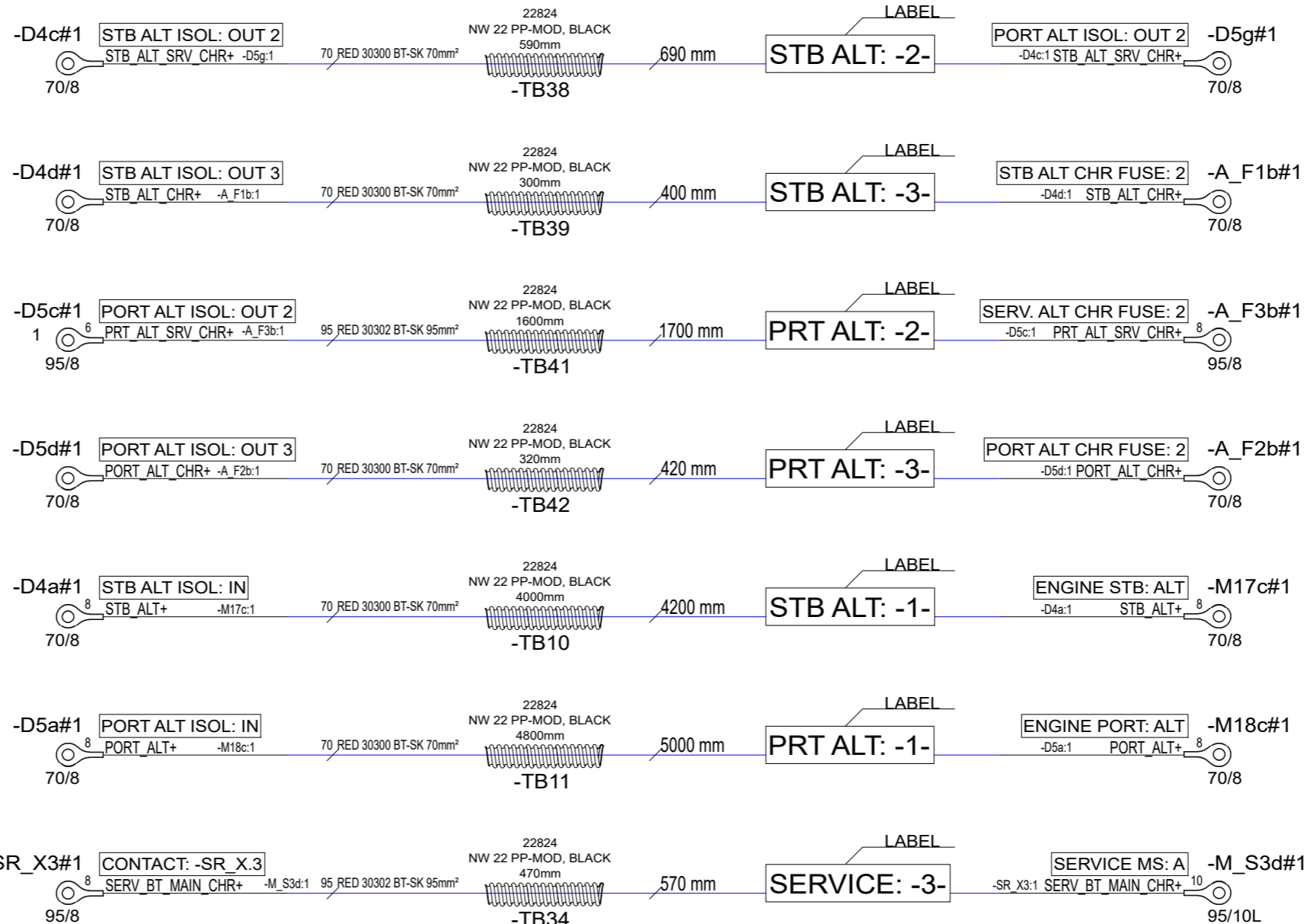

Packed as separate sets and included

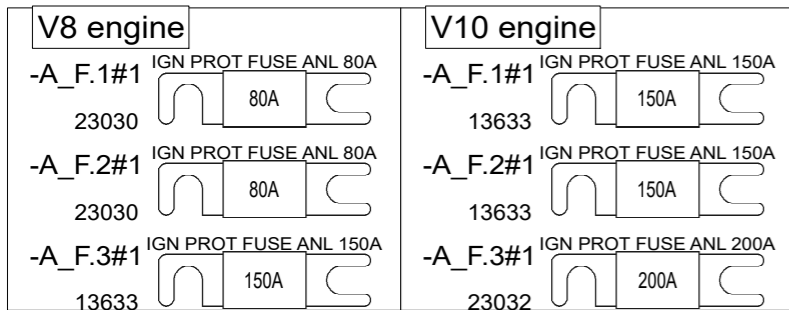

Customer installs correct fuses to
battery box according to engine type

26.9.2023	PF	E1: 2004855: Introduced drawing (Based on 29600)	Date	22.5.2019		Axopar			
13.10.2023	PF	F1: Import to F-revision	Drawing by	TuM		Boat		39902	
19.4.2024	PF	G1: 2005054; Not modified	Sheet rev.	1		37 MY20	Sub-product code	Product code	Project ID
Date of modification	Modified by	Description	Project rev.	G	Copyright by	Boat model	ALTERNATOR CABLES	HL	195 / 213
							V10	Loc	Sheet

NOTICE!
 BATTERY CABLES NEED TO ADD MARKINGS SHOWN IN EXAMPLE BELOW.
 EXEMPTION:
 ALL BLACK WIRES
 THIS MARKING IS NOT NEEDED.



MARKING SHOWN ABOVE ONLY TO CABLES LISTED BELOW.

EQUIVALENCY:	
mm2	AWG
50 mm2	= AWG0
70 mm2	= AWG2/0
95 mm2	= AWG3/0
120 mm2	= 250 kcmil

LOOK FOR EQUIVALENT AWG SIZE FOR mm2 AND ADD THIS TO CABLE MARKINGS.
 FOR EXAMPLE:
 CABLE SIZE IS 70mm2 --> MARKING AWG2/0.

NOTICE!
 BATTERY CABLES NEED TO ADD MARKINGS SHOWN IN EXAMPLE BELOW.
 EXEMPTION:
 ALL BLACK WIRES
 THIS MARKING IS NOT NEEDED.

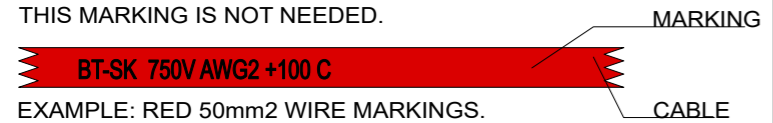

MARKING SHOWN ABOVE ONLY TO CABLES LISTED BELOW.

EQUIVALENCY:	
mm2	AWG
25 mm2	= AWG3
35 mm2	= AWG2
50 mm2	= AWG0
70 mm2	= AWG2/0
95 mm2	= AWG3/0
120 mm2	= 250 kcmil

LOOK FOR EQUIVALENT AWG SIZE FOR mm2 AND ADD THIS TO CABLE MARKINGS.
 FOR EXAMPLE:
 CABLE SIZE IS 70mm2 --> MARKING AWG2/0.

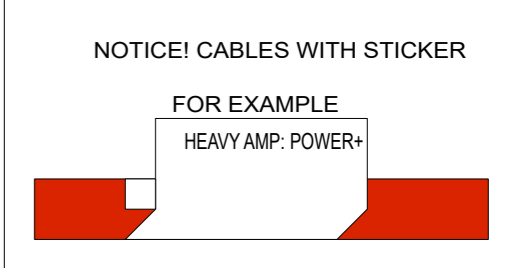
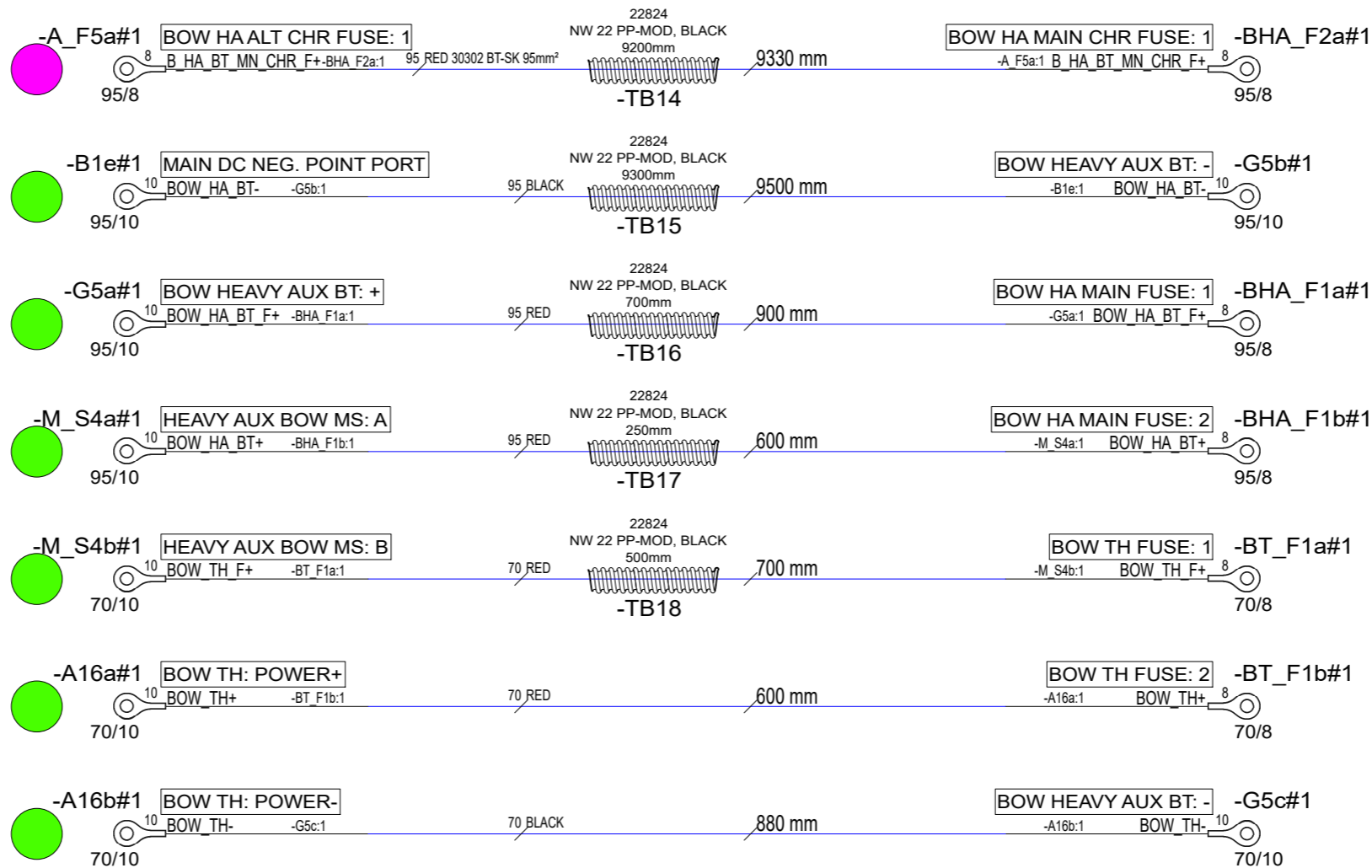

Packed as separately and included

V8 engine	V10 engine
-A_F.5#1 IGN PROT FUSE ANL 150A 13633	-A_F.5#1 IGN PROT FUSE ANL 250A 20011

INCLUDED

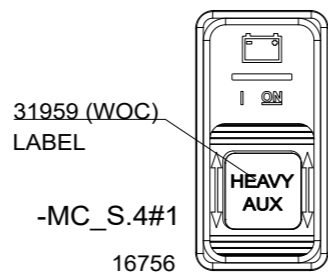

-MC_S.4#1
16756
HA MS CTRL SWITCH

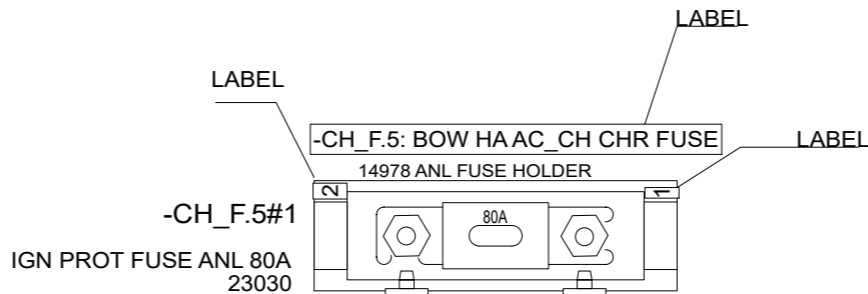

-CH_F.5#1
IGN PROT FUSE ANL 80A
23030

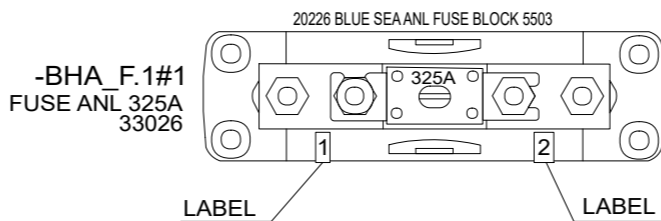

-BHA_F.1#1
FUSE ANL 325A
33026

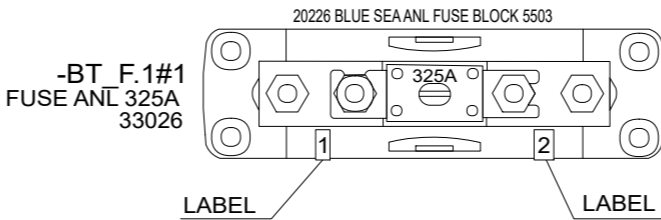

-BT_F.1#1
FUSE ANL 325A
33026

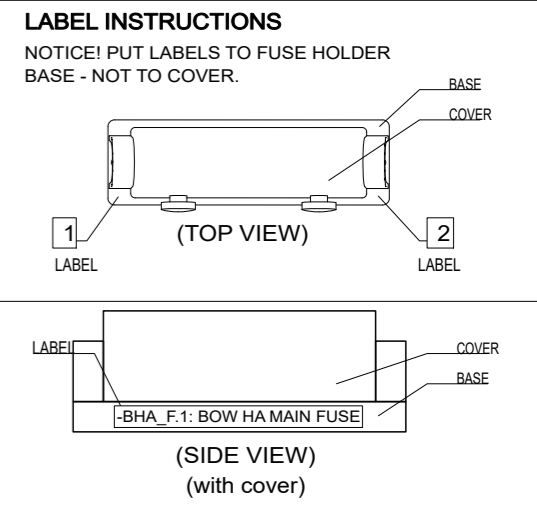

Customer installs correct fuses to battery box according to engine type

26.9.2023	PF	E1: 2004855: Introduced drawing (Based on 29602)	Date	22.5.2019	NAVIX designed solutions	Axopar	28584	39903	Project ID
13.10.2023	PF	F1: Import to F-revision	Drawing by	TuM		Boat	Sub-product code	Product code	
11.4.2024	PF	G2: 2005054; Isol. link rem, CH_F5 & cables added, MC_S4 label, lengths	Sheet rev.	2	Copyright by	37 MY20	BOW THRUSTER CABLE SET V10	Title	HL
Date of modification	Modified by	Description	Project rev.	G		Boat model			Loc

NOTICE! CABLES WITH STICKER

FOR EXAMPLE
HEAVY AMP: POWER+

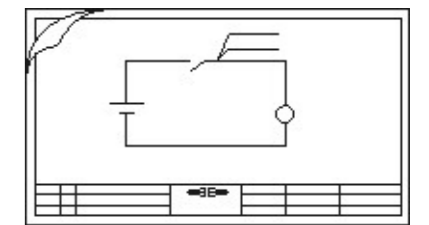

DOCUMENTS INCLUDED:
29602 BOW THRUSTER CABLE SET

LABEL
BOW HA CHR CABLES

(TO TOP OF PACKAGE)

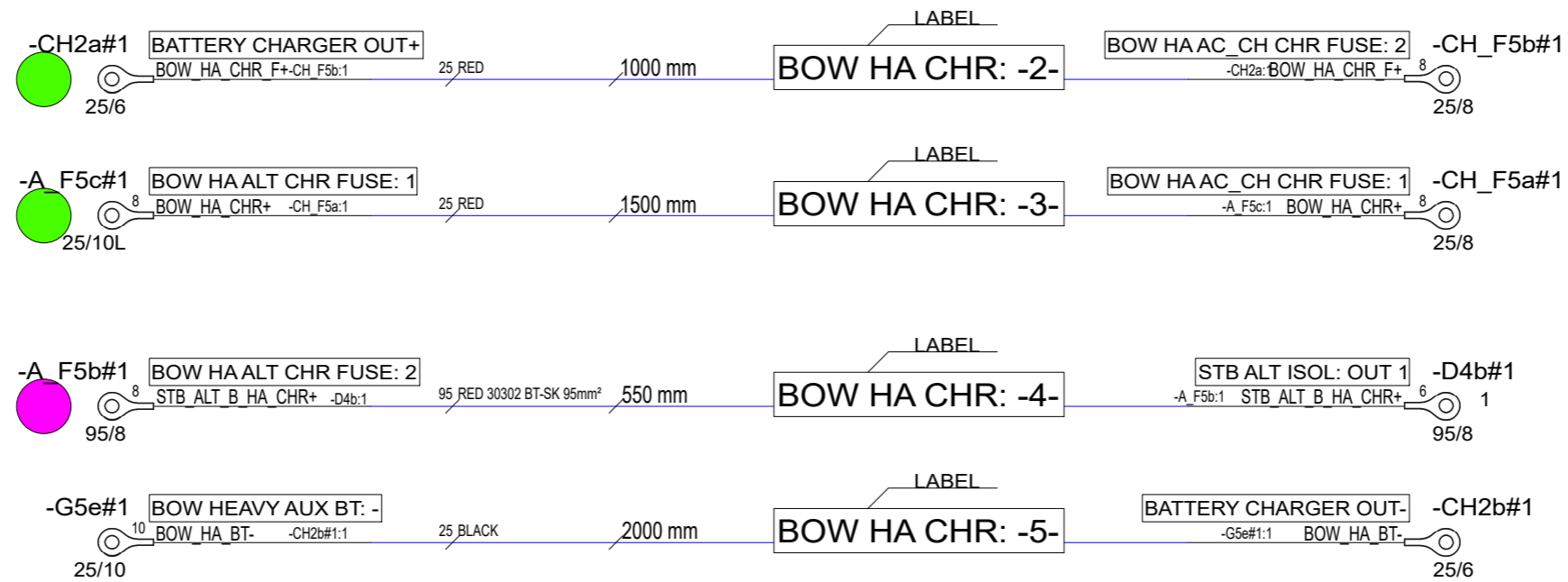

PACKED TO OWN PACKAGE.

NOTICE!
BATTERY CABLES NEED TO ADD MARKINGS
SHOWN IN EXAMPLE BELOW.

EXEMPTION:
ALL BLACK WIRES
THIS MARKING IS NOT NEEDED.

EXAMPLE: RED 50mm² WIRE MARKINGS.

MARKING SHOWN ABOVE ONLY TO CABLES LISTED BELOW.

LOOK FOR EQUIVALENT AWG SIZE FOR mm²
AND ADD THIS TO CABLE MARKINGS.

FOR EXAMPLE:
CABLE SIZE IS 70mm² --> MARKING AWG2/0.

EQUIVALENCY:	
mm ²	AWG
25 mm ²	= AWG3
35 mm ²	= AWG2
50 mm ²	= AWG0
70 mm ²	= AWG2/0
95 mm ²	= AWG3/0
120 mm ²	= 250 kcmil

NOTICE!
BATTERY CABLES NEED TO ADD MARKINGS
SHOWN IN EXAMPLE BELOW.

EXEMPTION:
ALL BLACK WIRES
THIS MARKING IS NOT NEEDED.

EXAMPLE: RED 16mm² WIRE MARKINGS.

MARKING SHOWN ABOVE ONLY TO CABLES LISTED BELOW.

LOOK FOR EQUIVALENT AWG SIZE FOR mm²
AND ADD THIS TO CABLE MARKINGS.

FOR EXAMPLE:
CABLE SIZE IS 25mm² --> MARKING AWG3.

EQUIVALENCY:	
mm ²	AWG
10 mm ²	= AWG8
16 mm ²	= AWG6
25 mm ²	= AWG3
35 mm ²	= AWG2

Date of modification	Modified by	Description
26.9.2023	PF	E1: 2004855: Introduced drawing (Based on 29602)
13.10.2023	PF	F1: Import to F-revision
11.4.2024	PF	G2: 2005054; Isol. link rem, CH_F5 & cables added, MC_S4 label, lengths

Date	6.7.2019
Drawing by	TuM
Sheet rev.	2
Project rev.	G

NAVIX
designed solutions
Copyright by

Axopar	39903	Project ID
Boat	37 MY20	Sub-product code
Boat model	BOW THRUSTER CABLE SET V10	Product code
	HL	197 / 213
	Loc	Sheet

CUSTOMER: INSTALLED AS PER AXOPAR INSTRUCTIONS

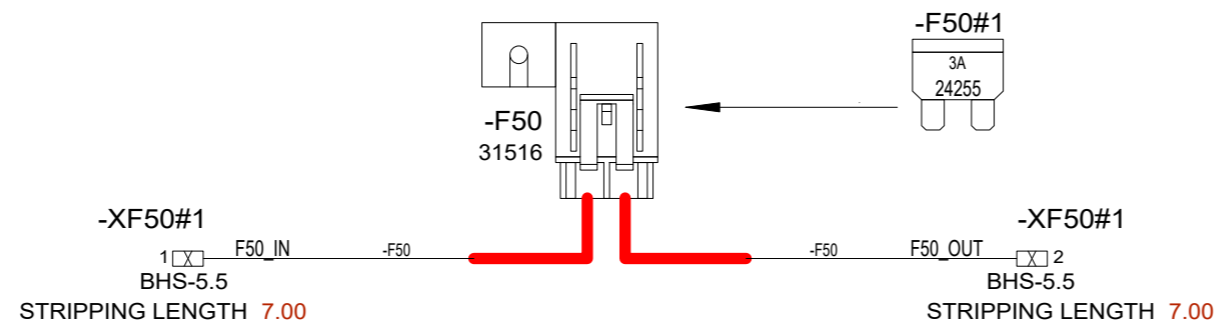

27.11.2023	PF	2004954; New item
Date of modification	Modified by	Description

Date	27.11.2023
Drawing by	TuM
Sheet rev.	1
Project rev.	G



Axopar
Boat
37 MY20
Boat model

Sub-product code	40334
LIVEWELL FUSE RETROFIT KIT	HL
Title	Loc

Product code	40334	Project ID
		198 / 213
		Sheet

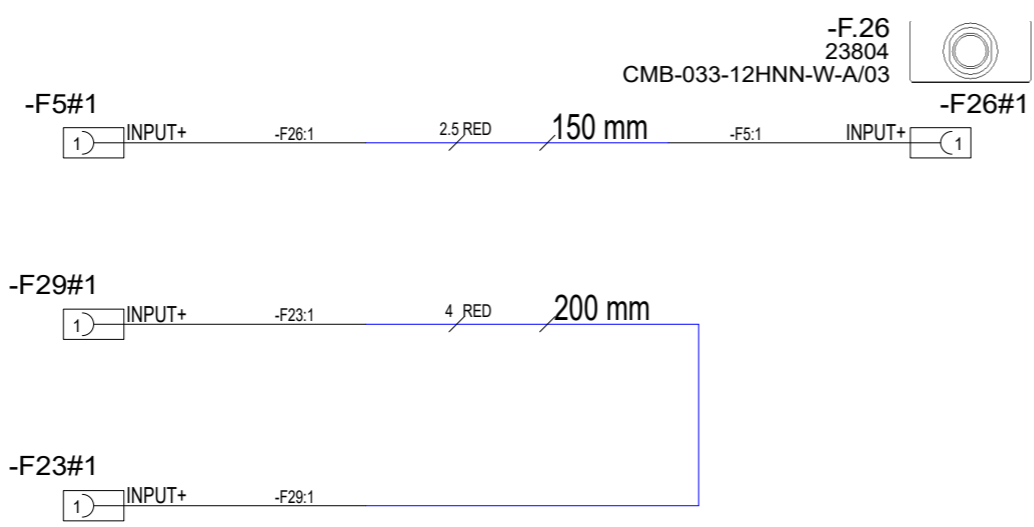

			Date	30.11.2023	Axopar					
			Drawing by	TuM	Boat		Sub-product code		40394	
			Sheet rev.	1	37 MY20		LIVEWELL CIRCUIT		HL	
Date of modification	Modified by	Description	Project rev.	G	Boat model		BREAKER RETROFIT		Loc	
1	2	3	4	5	6	7	8	199 / 213		Sheet



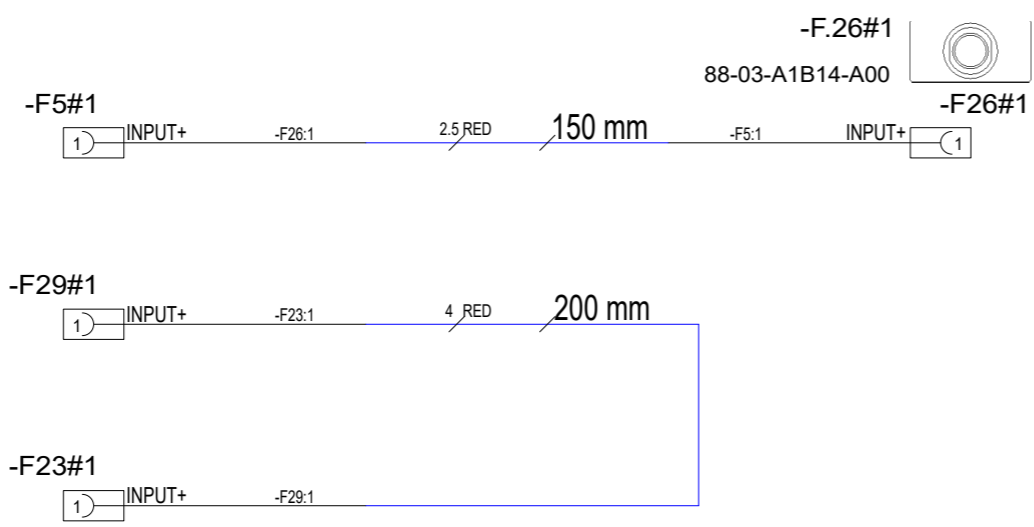

			Date	30.11.2023	Axopar					
			Drawing by	TuM	Boat		Sub-product code		Product code	
			Sheet rev.	1	37 MY20		LIVEWELL CIRCUIT		40405	
Date of modification			Modified by		Boat model		BREAKER RETROFIT		Project ID	
Description			Project rev.	G			HL		200 / 213	
							Loc		Sheet	
1	2	3	4	5	6	7	8			

NOTICE!
 VERIFY THAT ALL CABLES HAVE MARKINGS
 SHOWN IN EXAMPLE BELOW.
 EXEMPTION:
 ALL <500mm WIRES AND BLACK WIRES
 THIS MARKING IS NOT NEEDED.

R2 ISO 6722 100V AWG16 +100 C
 EXAMPLE: RED 1,5mm² WIRE MARKINGS.

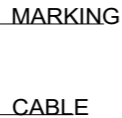

CUSTOMER: When no light
 pack is selected, install FOUR
 (4) pieces to main cabin

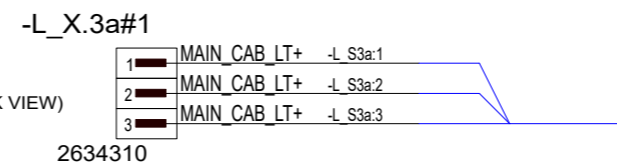
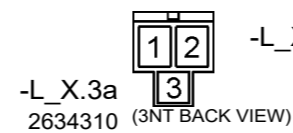
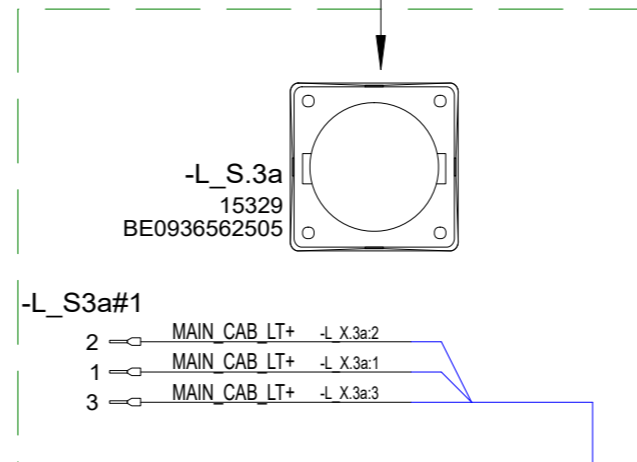
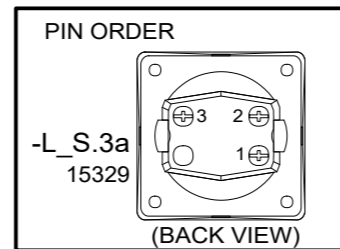
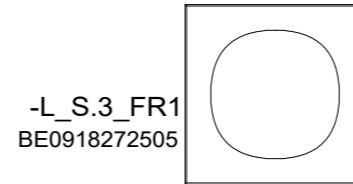

250 mm

8.4.2024	PF	G1: 2005054; New product	Date	12.3.2024	NAVIX	Axopar			
			Drawing by	PF	designed solutions	Boat	Sub-product code	41158	Product code
			Sheet rev.	1	Copyright by	37 MY25	BASIC LIGHT SWITCH	HL	Project ID
Date of modification	Modified by	Description	Project rev.	G		Boat model	Title	Loc	201/ 213 Sheet

NOTICE!
 VERIFY THAT ALL CABLES HAVE MARKINGS
 SHOWN IN EXAMPLE BELOW.
 EXEMPTION:
 ALL <500mm WIRES AND BLACK WIRES
 THIS MARKING IS NOT NEEDED.

R2 ISO 6722 100V AWG16 +100 C
 EXAMPLE: RED 1,5mm² WIRE MARKINGS.

MARKING

CABLE

CUSTOMER: When no light
 pack is selected, install TWO
 (2) pieces to main cabin

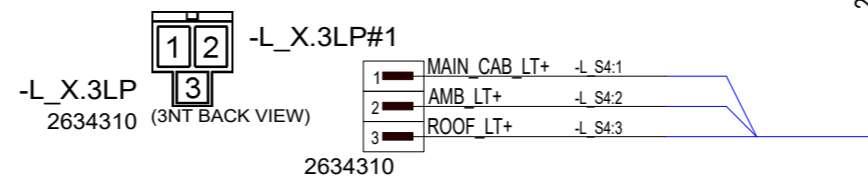
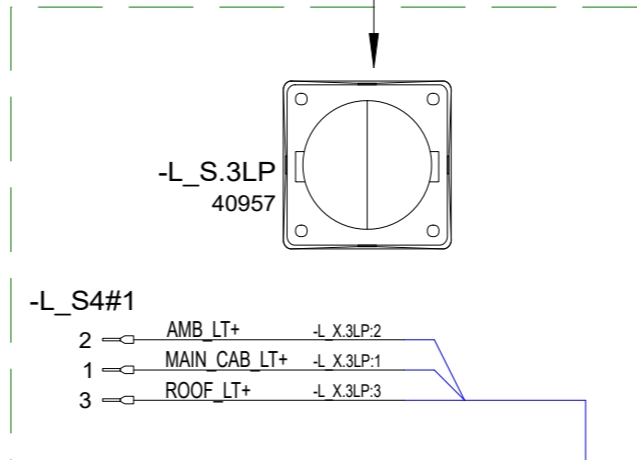
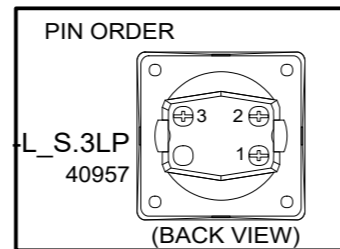
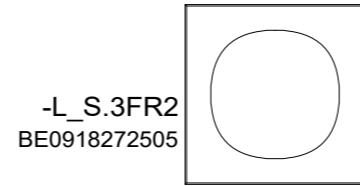

8.4.2024	PF	G1: 2005054; New product	Date	15.3.2024	NAVIX designed solutions	Axopar			
			Drawing by	PF	Copyright by	Boat	Sub-product code	41159	Product code
			Sheet rev.	1		37 MY25	LIGHT PACK SWITCH	HL	Project ID
Date of modification	Modified by	Description	Project rev.	G		Boat model	Title	Loc	202 / 213 Sheet

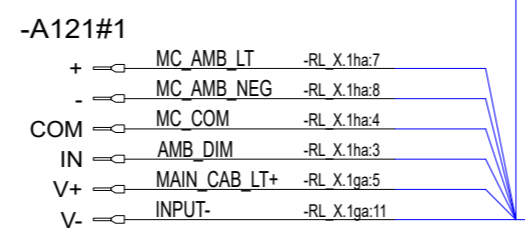
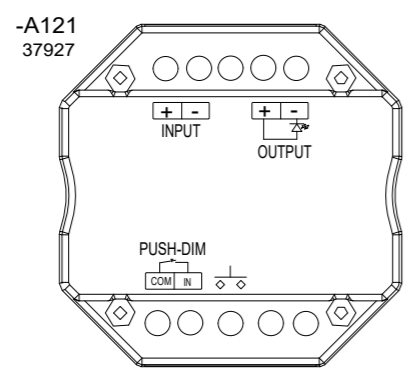
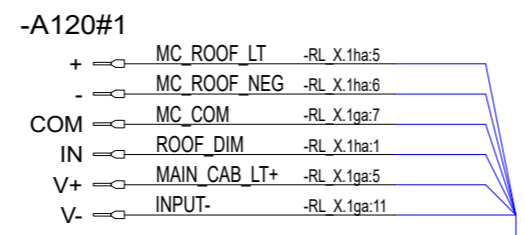
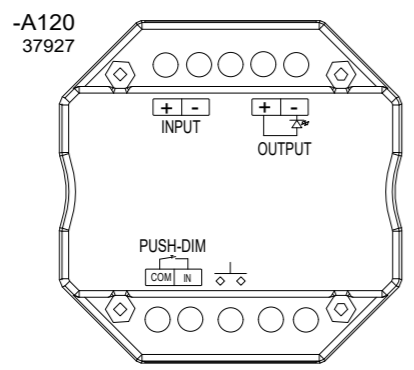

CUSTOMER: CONNECT BOTH CONNECTORS TO HULL HARNESS NEAR RELAY UNIT
 NOTICE! FROM RELAY UNIT LEAVE RL_X.1g UNCONNECTED

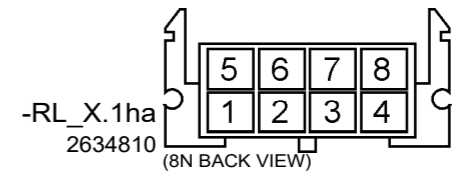
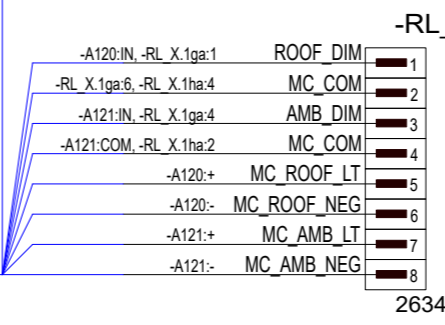
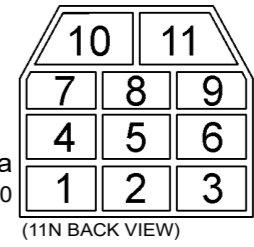
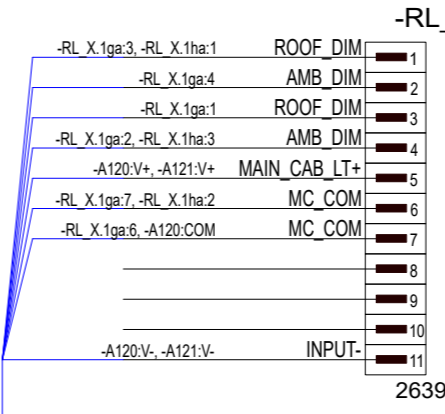
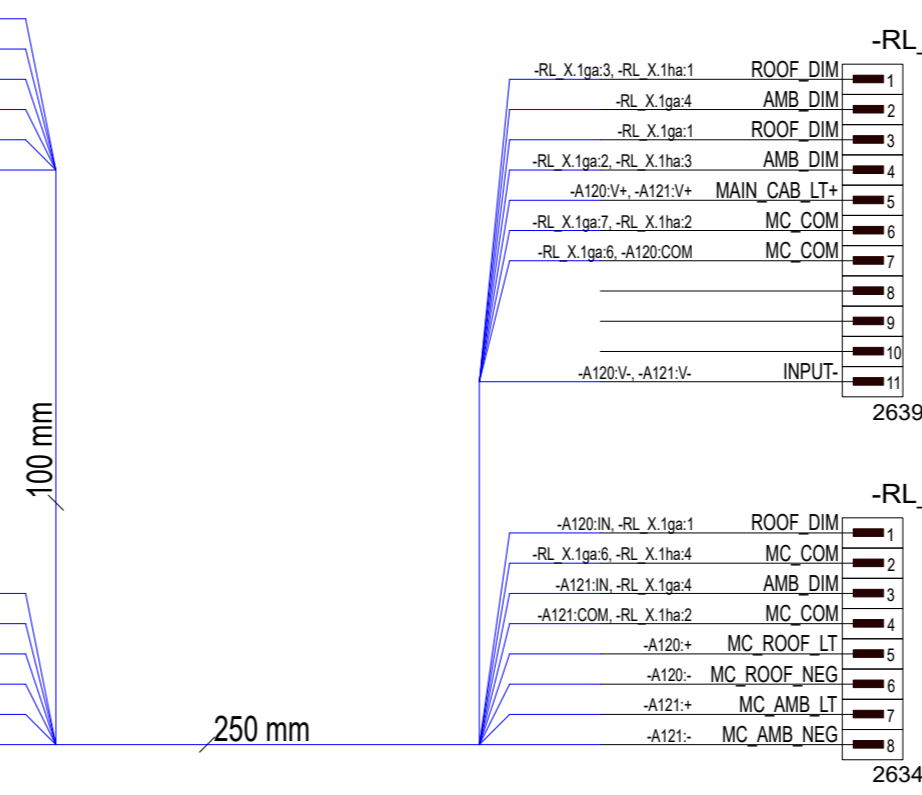

8.4.2024	PF	G1: 2005054; New product	Date 15.3.2024
			Drawing by PF
			Sheet rev. 1
Date of modification	Modified by	Description	Project rev. G



Axopar			41160	
Boat	Sub-product code	Product code	Project ID	
37 MY25	DIMMER KIT	HL	203 / 213	
Boat model	Title	Loc	Sheet	

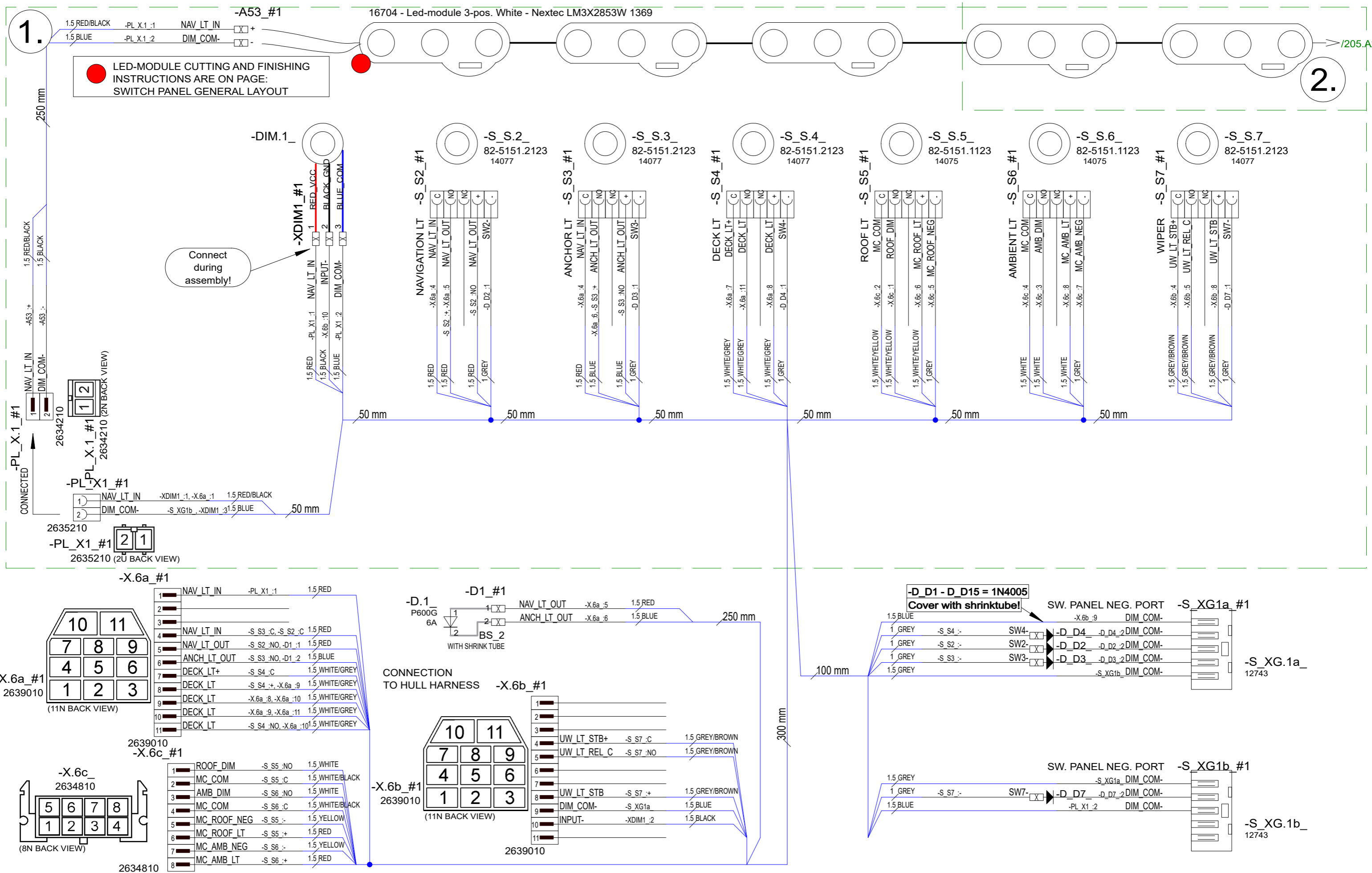

2.4.2024	PF	G1:2005054; New product	Date	2.4.2024
			Drawing by	TuM
			Sheet rev.	1
			Project rev.	G
Date of modification	Modified by	Description		

designed solutions

Copyright by

Axopar

Boat

37 MY25

Boat model

SEE EXP VIEW

Sub-product code

SWITCH PANEL LIGHT PACK

Title

41161

Product code

HL

Loc

Project ID

204 / 213

Sheet

3.

LED-MODULE CUTTING AND FINISHING INSTRUCTIONS ARE ON PAGE: SWITCH PANEL GENERAL LAYOUT

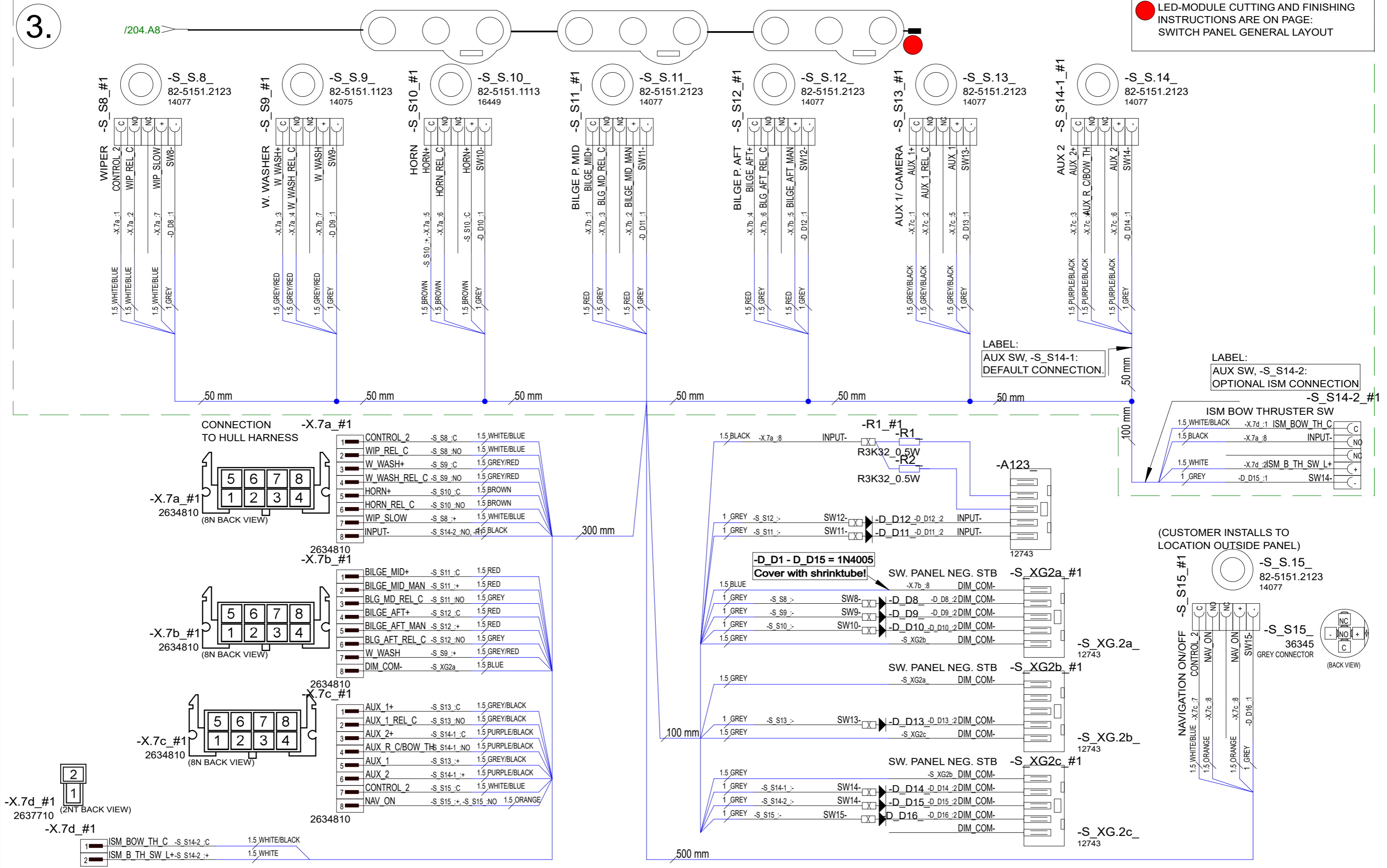

2.4.2024	PF	G1:2005054; New product	Date	2.4.2024
			Drawing by	TuM
			Sheet rev.	1
Date of modification	Modified by	Description	Project rev.	G



Axopar	SEE EXP VIEW	41161	Project ID
Boat	Sub-product code	Product code	
37 MY25	SWITCH PANEL LIGHT	HL	205 / 213
Boat model	PACK	Loc	

SWITCH PANEL GENERAL LAYOUT / LED MODULE CUTTING & FINISHING

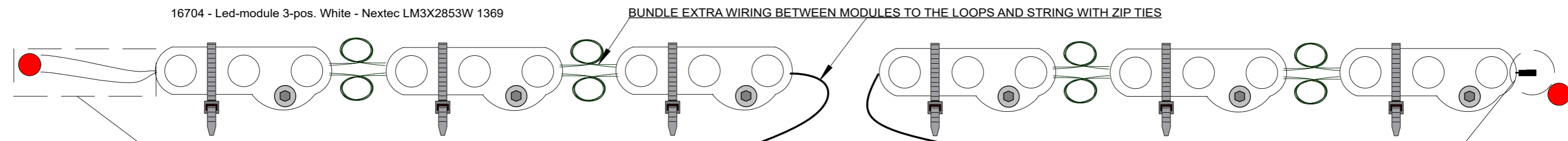
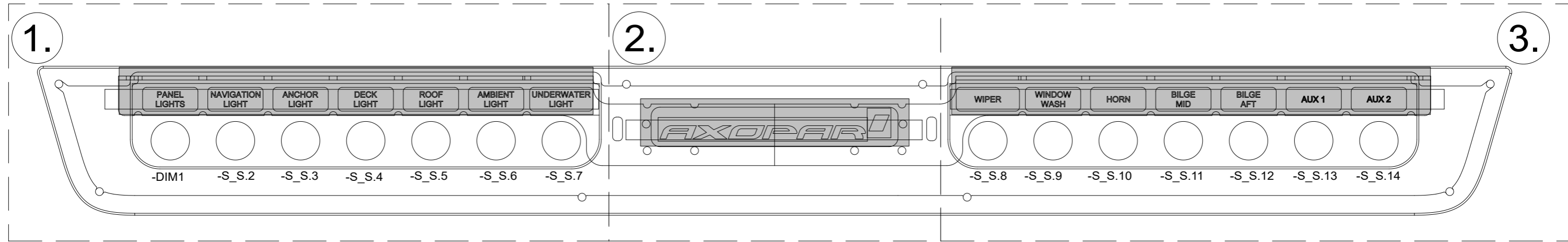

CUT LED MODULES INPUT SIDE OF THE WIRES APPROX. 60mm LENGTH (SHOULD BE ABOUT THE CENTER POS. BETWEEN 2 MODULES)

STRIP WIRE ENDS APPROX. 7mm AND CRIMP WIRES TO THE BUTT SPLICE CONNECTORS -A53.

BUNDLE EXTRA WIRING BETWEEN MODULES TO THE LOOPS AND STRING WITH ZIP TIES

ATTACH ALL LED MODULES TO THE BRACKET 36371 WITH M3X12 BH HEX BOLT A4, NUT M3 AND 2-SIDED TAPE. ADD CABLE TIE. SEE ALSO EXP. VIEW

TURN THE ENDS OF CABLE TIES TOWARDS TO THE PANEL!

1. CUT THE WIRES APPROX. 40mm. (JUST CUT, DO NOT STRIP!)

2. BEND THE WIRES TO THE SHAPE OF "U".

3. ADD APPROX. 20mm OF HEAT SHRINK TUBE "17418" OVER THE BENDED WIRES.

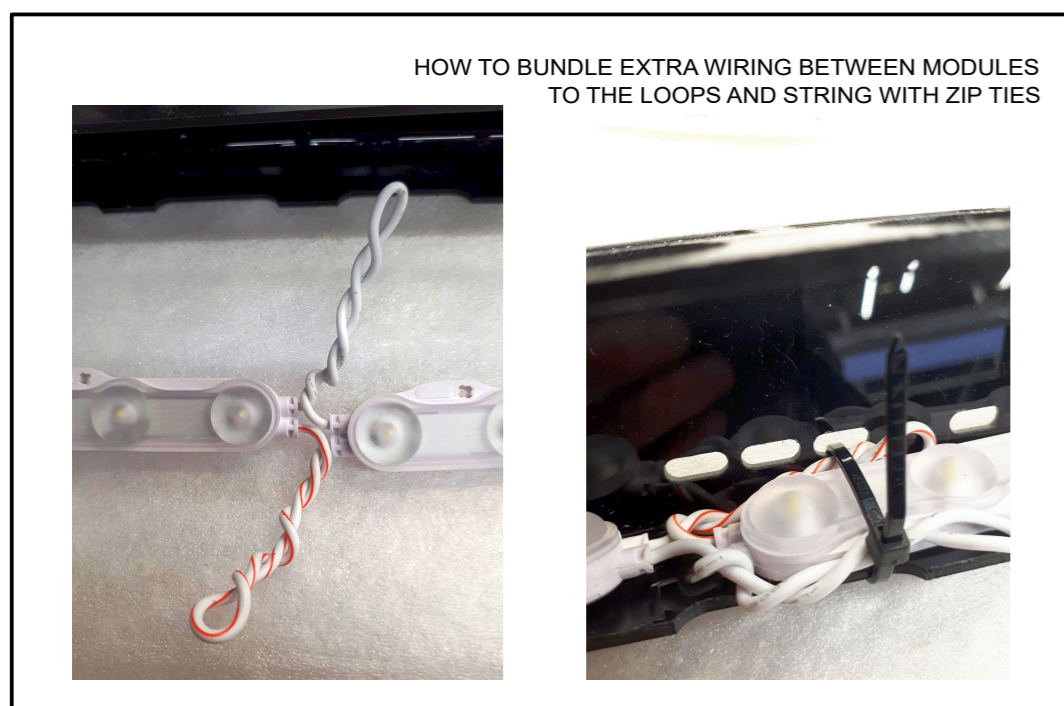

NOTICE!
VERIFY THAT ALL CABLES HAVE MARKINGS SHOWN IN EXAMPLE BELOW.

EXEMPTION:
ALL <500mm WIRES AND BLACK WIRES
THIS MARKING IS NOT NEEDED.

EXAMPLE: RED 1,5mm² WIRE MARKINGS.

2.4.2024	PF	G1:2005054; New product	Date	2.4.2024		Axopar	SEE EXP VIEW	41161	Project ID
			Drawing by	TuM		Boat	Sub-product code	Product code	
			Sheet rev.	1	Copyright by	37 MY25	SWITCH PANEL LIGHT	HL	206 / 213
Date of modification	Modified by	Description	Project rev.	G		Boat model	PACK	Loc	
1		2	4		5	6	7	8	Sheet

29211_AXOPAR_37_MY20_SWITCH_PANEL

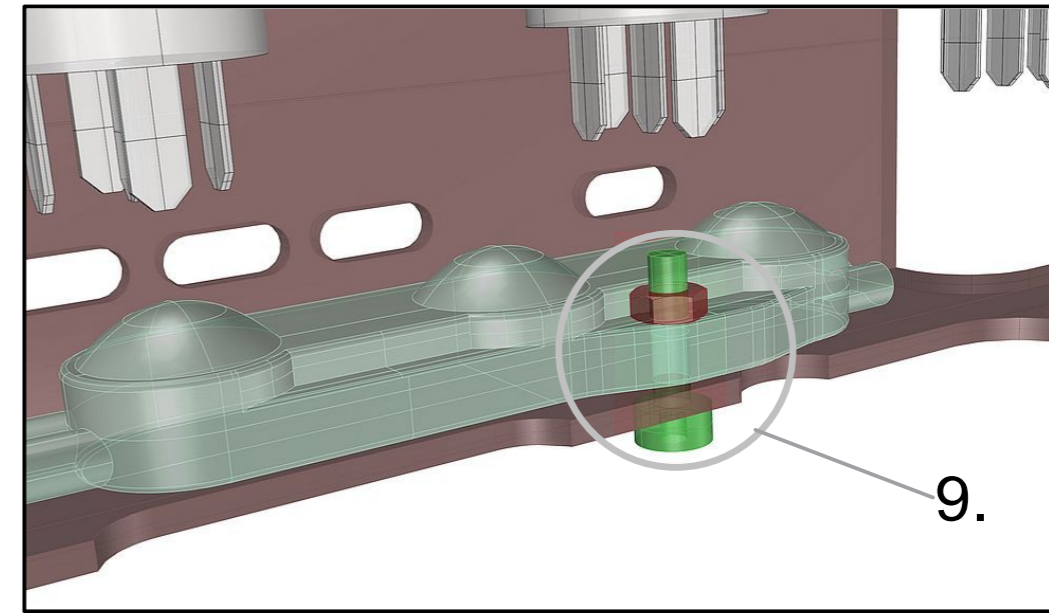
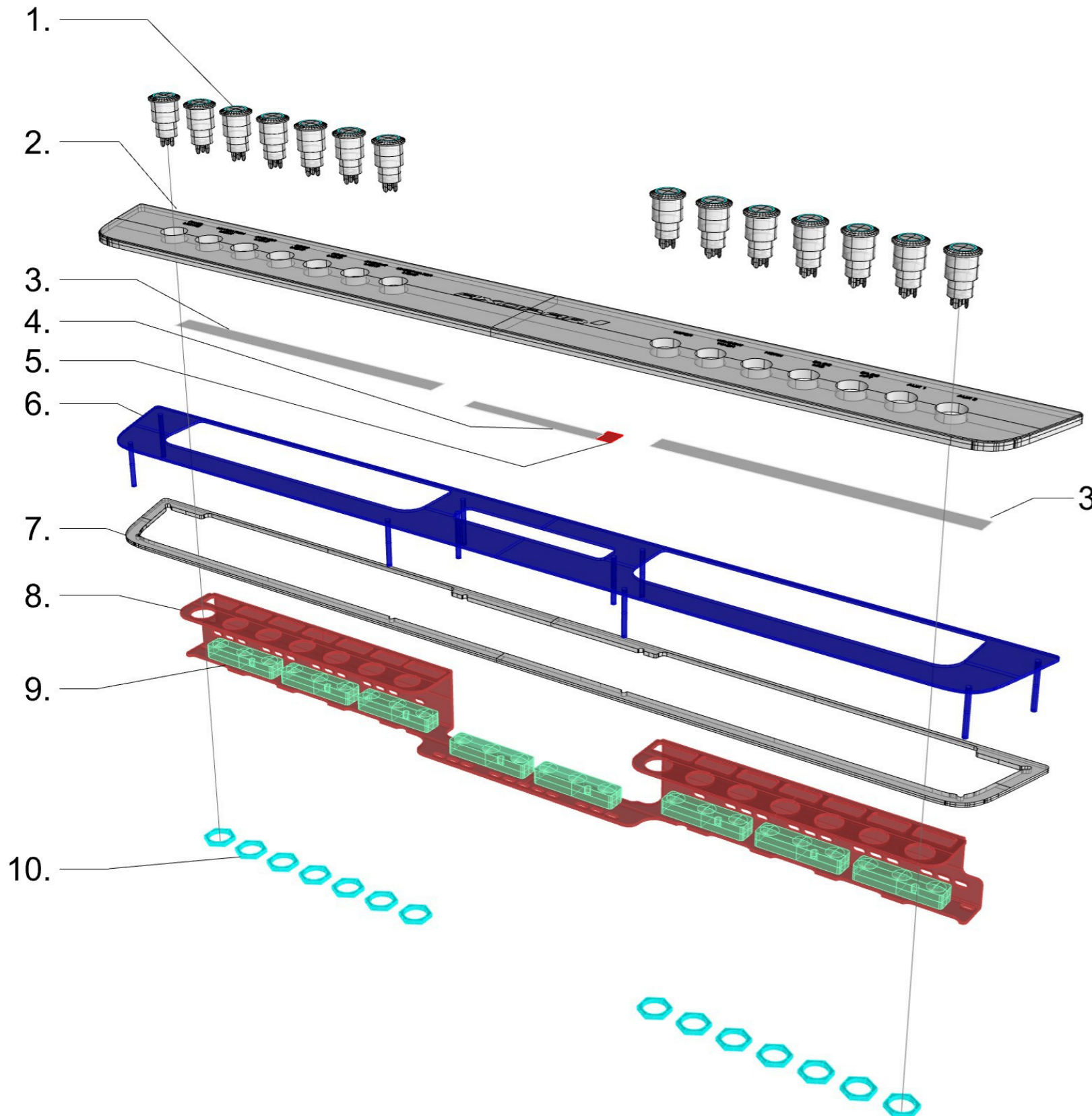

29211_AXOPAR_37_MY20_SWITCH_PANEL

1. 14PCS HALO SWITCH (AS IN DIAGRAM)
2. 1PCS 29767_AXOPAR_37_MY20_ACRYL_SWITCH_PANEL_(WOC)
3. 2PCS 29771_AXOPAR_37_MY20_SWITCH_PANEL_TEXT_STICKER (PLACE BEHIND THE TEXT AREA IN 29767)
4. 1PC 23722_AXOPAR_28_SWITCH_PANEL_LOGO_WHITE_STICKER (PLACE BEHIND THE TEXT AREA IN 29767)
5. 1PC 23723_AXOPAR_28_SWITCH_PANEL_LOGO_RED_STICKER (PLACE BEHIND THE TEXT AREA IN 29767)
6. 1PC 29768_AXOPAR_37_MY20_SWITCH_PANEL_METAL_BACK_FRAME ATTACH TO 29767 WITH BLACK MS-POLYMER GLUE
7. 1PC 29769_AXOPAR_37_MY20_SWITCH_PANEL_GASKET_(WOC) GLUE WITH 2-SIDED TAPE TO THE BACKSIDE OF 29768
8. 1PC 36371_AXOPAR_SWITCH_PANEL_LED_MODULE_BRACKET_(WOC)
9. 8PCS 16704 LED MODULE WHITE ATTATCH TO 36371 WITH M3X12 BH HEX BOLT A4 AND NUT ATTACH TO BRACKET WITH CABLE TIES AND 2-SIDED TAPE
10. 14PCS HALO SWITCH NUT

TE 20.05.2019
 TE 11.09.2019
 JSC 18.10.2019
 MN 18.11.2019
 TE 11.01.2022
 HL 11.03.2022

EXP VIEW

2.4.2024	PF	G1:2005054; New product	Date	2.4.2024	NAVIX designed solutions	Axopar	SEE EXP VIEW	41161	Project ID
			Drawing by	TuM		Boat	Sub-product code	Product code	
			Sheet rev.	1	Copyright by	37 MY25	SWITCH PANEL LIGHT	HL	207 / 213 Sheet
Date of modification	Modified by	Description	Project rev.	G		Boat model	PACK	Loc	

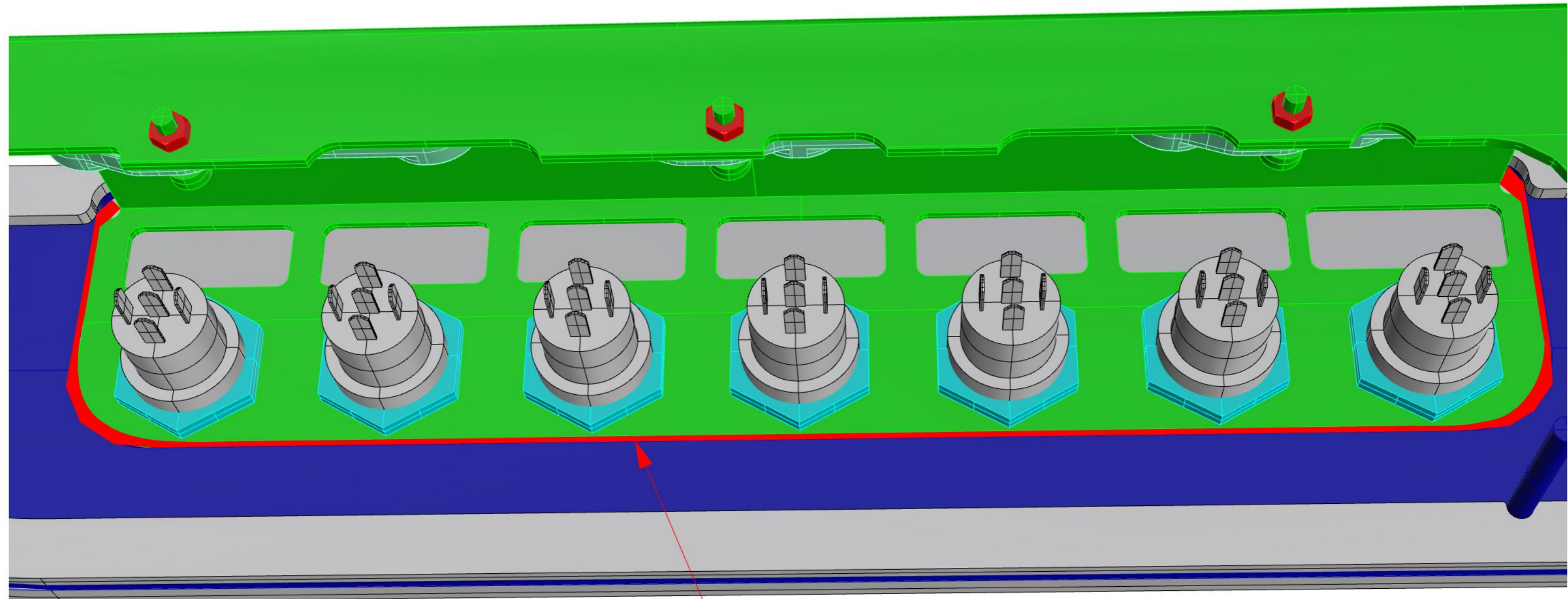

FILL THE GAP BETWEEN
 METAL FRAME AND LED BRACKET
 WITH 21119 MS-POLYMER BLACK GLUE
 GLUE MUST BE FLUSH WITH PANELS

2.4.2024	PF	G1:2005054; New product	Date	2.4.2024	 NAVIX designed solutions Copyright by	Axopar	SEE EXP. VIEW	41161	Project ID
			Drawing by	TuM		Boat	Sub-product code	Product code	
			Sheet rev.	1		37 MY25	SWITCH PANEL LIGHT	HL	208 / 213
Date of modification	Modified by	Description	Project rev.	G	Boat model	Title	Loc	Sheet	

Axopar 37 MY20 SWITCH PANEL 41161 INSPECTION SHEET

PRUDUCT LABEL

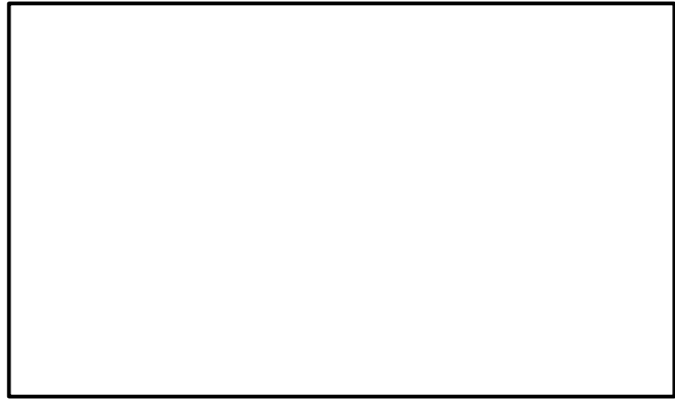

TEST

- 1) S2, S3, S4 should be pressed. No other buttons may be pressed during entire test. Power source off.
- 2) Connect -X.6b/9 and -X.7b/8 with a wire.
- 3) Connect positive (+12V) to connectors listed below
- 4) Connect negative (-) to -X.6b/10 and -X.7a/8. Turn power on.
- 5) Observe, change brightness and turn on/off by pressing DIM1. Panel lights and switch halos must illuminate. S11 and S12 should illuminate constantly with full brightness, S5 and S6 should not illuminate at all. All other lights should turn on/off/dim from DIM1.

- | | |
|----------------------|----------------------|
| Connect positive (+) | Connect negative (-) |
| X.6a_/1 | X.6b_/10 |
| X.6a_/4 | X.7a_/8 |
| X.6a_/7 | |
| X.6b_/8 | |
| X.7a_/7 | |
| X.7b_/7 | |
| X.7a_/5 | |
| X.7b_/2 | |
| X.7b_/5 | |
| X.7c_/5 | |
| X.7c_/6 | |
| X.7d_/4 | |

PASS / FAIL

DATE

TESTED BY

TEST INSTRUCTIONS

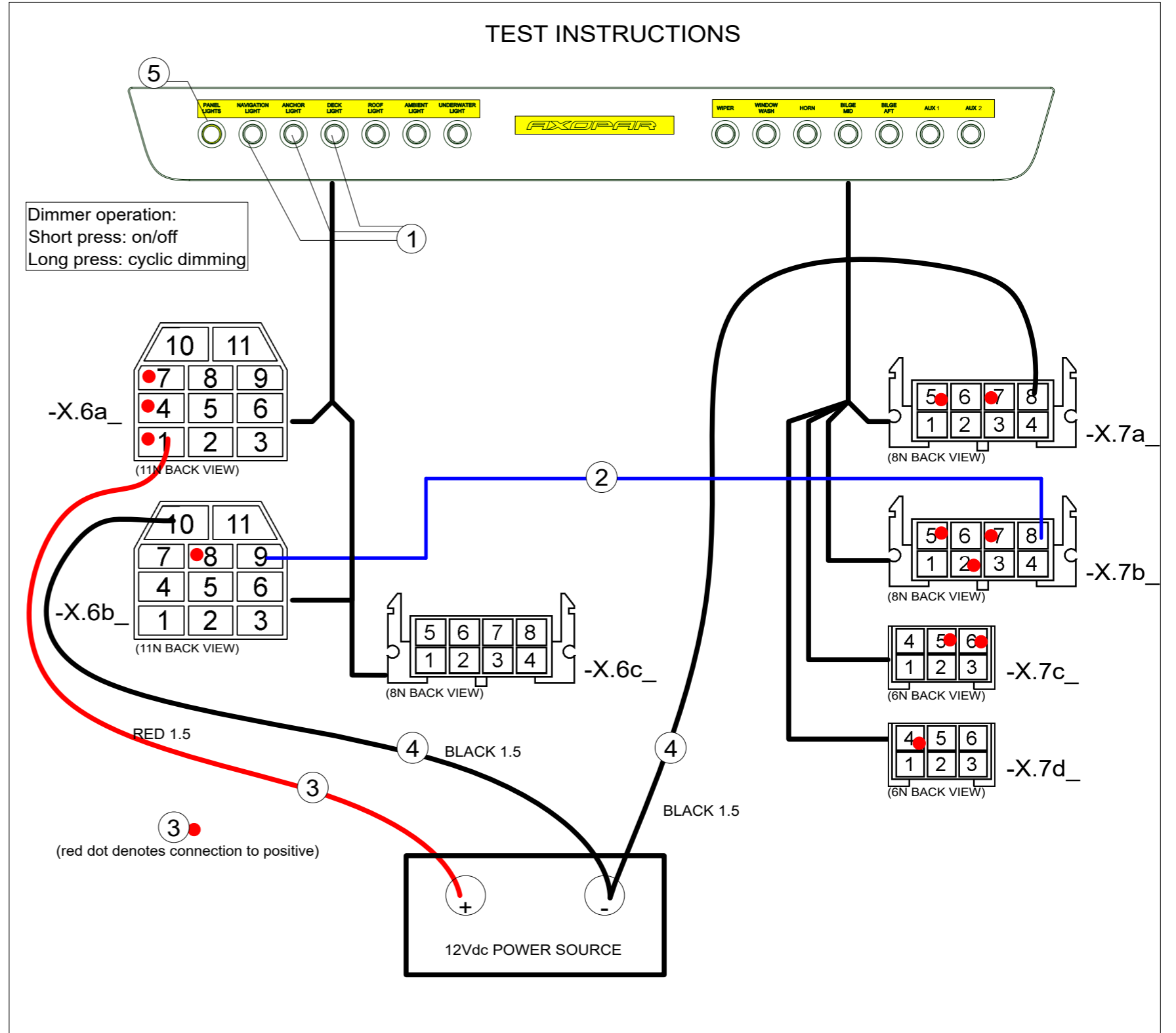

2.4.2024	PF	G1:2005054; New product	Date	2.4.2024		Axopar	SEE EXP VIEW	41161	Project ID
			Drawing by	TuM		Boat	Sub-product code	Product code	
			Sheet rev.	1	Copyright by	37 MY25	SWITCH PANEL LIGHT	HL	209 / 213
Date of modification	Modified by	Description	Project rev.	G		Boat model	PACK	Loc	

-A118
37927

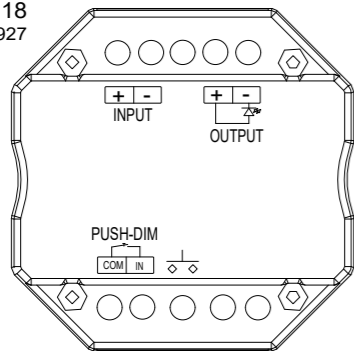

-A118#1

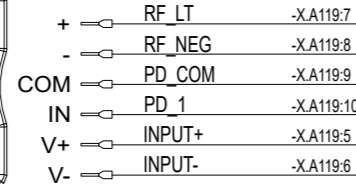

-A119
37927

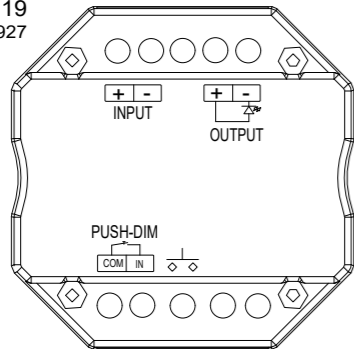

-A119#1

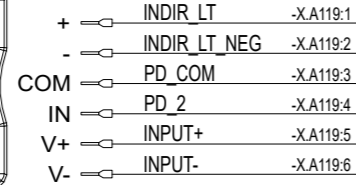

100 mm

500 mm

-X.A119#1 -X.A119#1

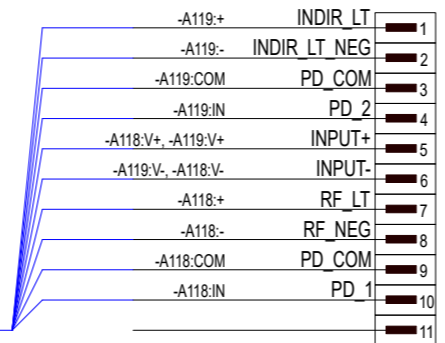

2639010

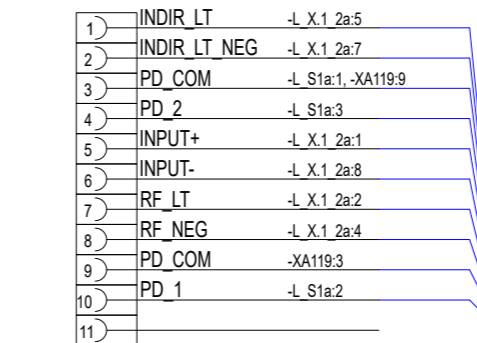

2638010

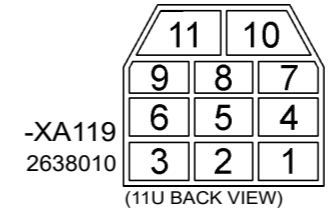
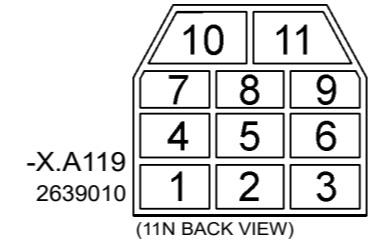

250 mm

CONNECTION
TO FWD CABIN HARNESS
or
TO AFT CABIN HARNESS

-L_X.1_2a#1

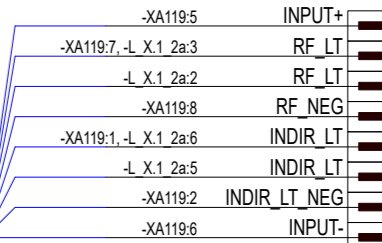

2634810

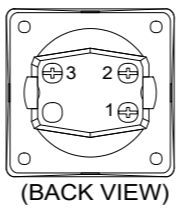
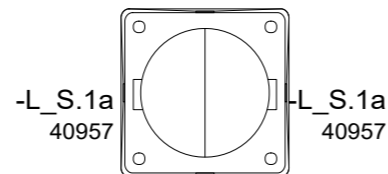

-L_S1a#1

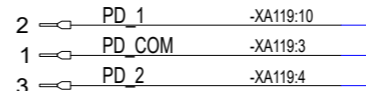

250 mm

-L_S.1_FR

BE0918272505

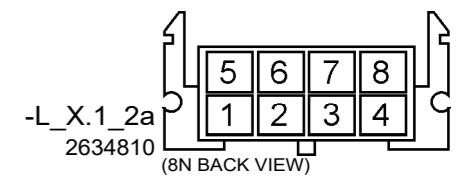

8.4.2024	PF	G1: 2005054; New product	Date	27.3.2024		Axopar			
			Drawing by	PF		Boat		41196	
			Sheet rev.	1		37 MY25	Sub-product code	Product code	Project ID
Date of modification	Modified by	Description	Project rev.	G	Copyright by	Boat model	FRONT AND AFT CABIN LIGHT SWITCH	HL	210 / 213
1		2	4				Title	Loc	Sheet

NOTICE!
 BATTERY CABLES NEED TO ADD MARKINGS SHOWN IN EXAMPLE BELOW.
 EXEMPTION:
 ALL BLACK WIRES
 THIS MARKING IS NOT NEEDED.

MARKING
 BT-SK 750V AWG2 +100 C

CABLE

EXAMPLE: RED 50mm² WIRE MARKINGS.

MARKING SHOWN ABOVE ONLY TO CABLES LISTED BELOW.

EQUIVALENCY:	
mm ²	AWG
25 mm ²	= AWG3
35 mm ²	= AWG2
50 mm ²	= AWG0
70 mm ²	= AWG2/0
95 mm ²	= AWG3/0
120 mm ²	= 250 kcmil

LOOK FOR EQUIVALENT AWG SIZE FOR mm² AND ADD THIS TO CABLE MARKINGS.

FOR EXAMPLE:
 CABLE SIZE IS 70mm² --> MARKING AWG2/0.

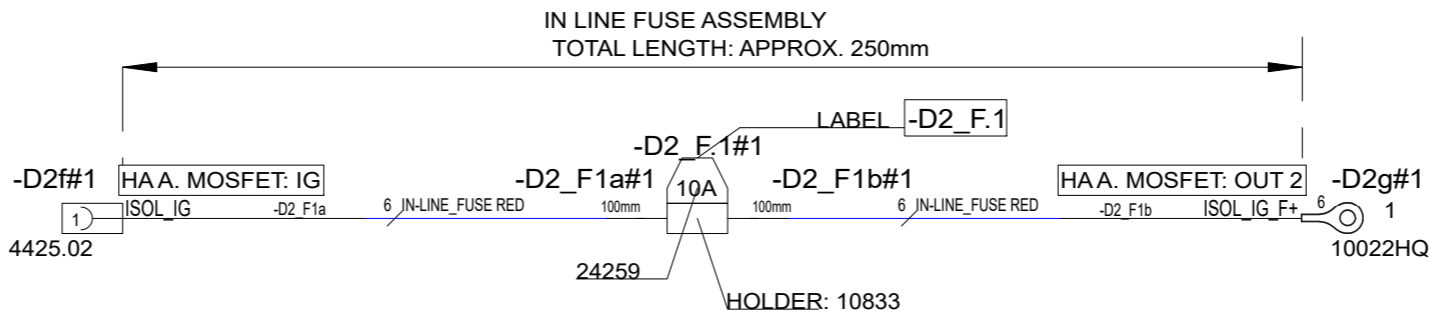

NOTICE! CABLES WITH STICKER

FOR EXAMPLE
 HEAVY AMP: POWER+

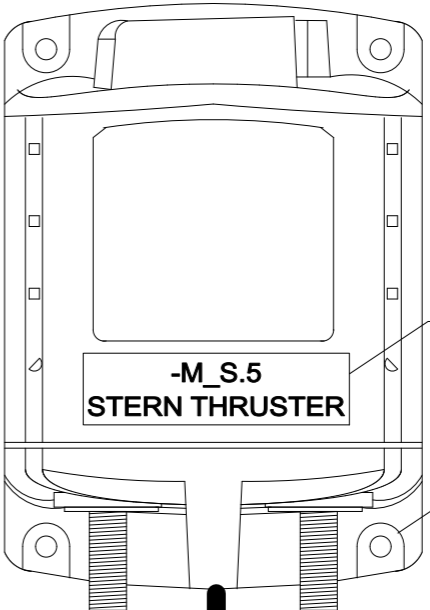
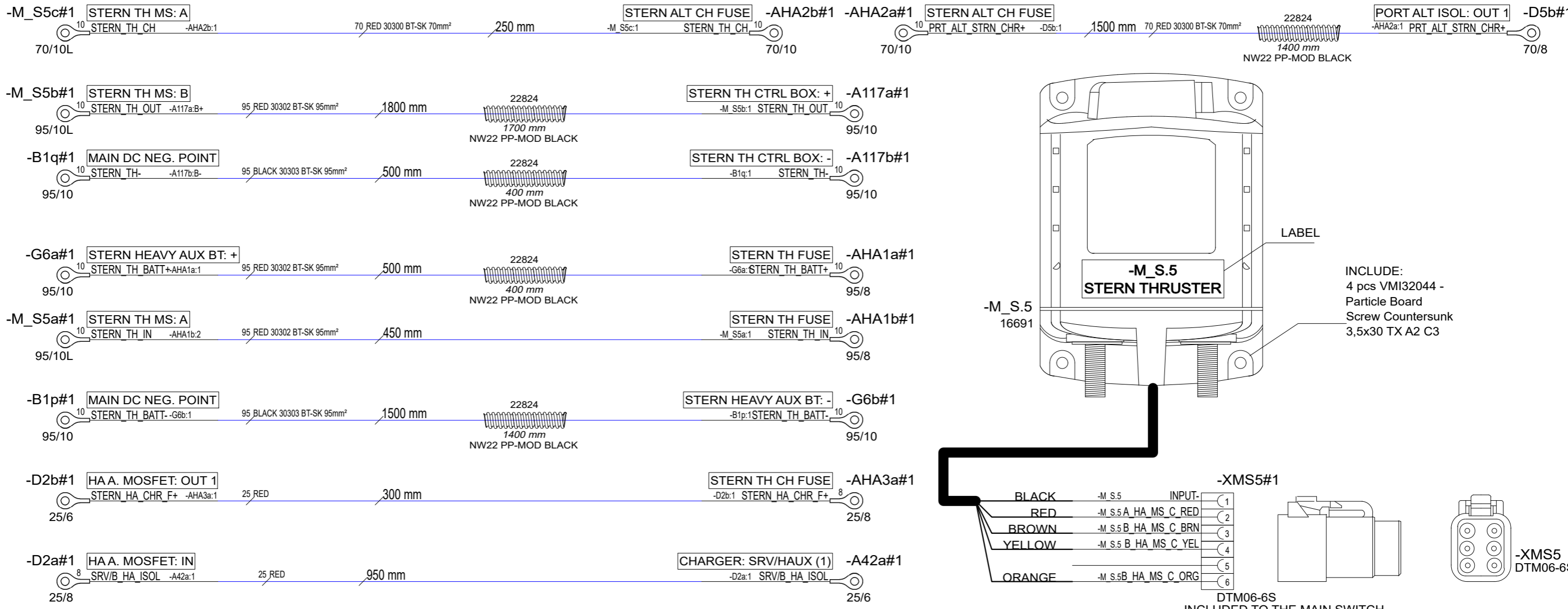
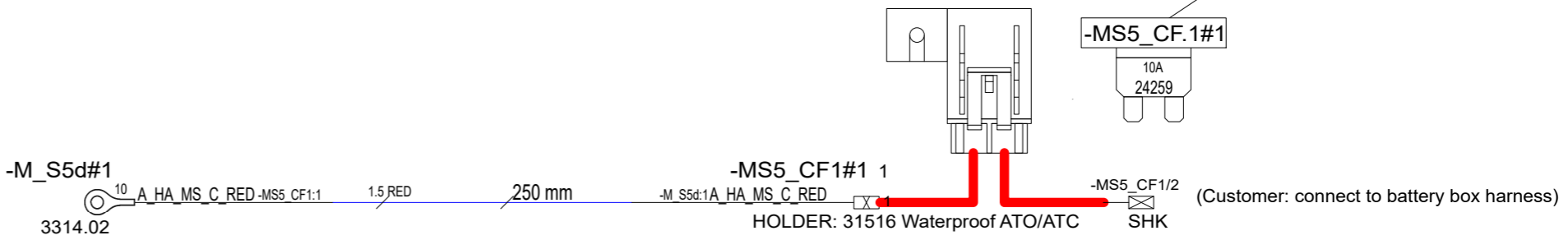

INCLUDE:
 4 pcs VMI32044 - Particle Board
 Screw Countersunk 3,5x30 TX A2 C3

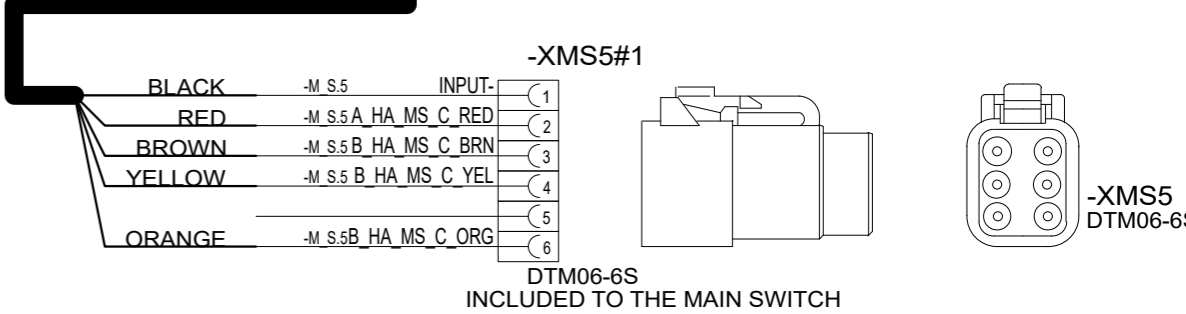

19.4.2024	PF	G1: 2005054; New product	Date	20.2.2024	NAVIX designed solutions	Axopar	See exp. view	41197	Project ID
			Drawing by	PF	Copyright by	Boat	Sub-product code	Product code	
			Sheet rev.	1		37 MY25	STERN THRUSTER	HL	211/ 213
Date of modification	Modified by	Description	Project rev.	G		Boat model	CABLES	Loc	Sheet

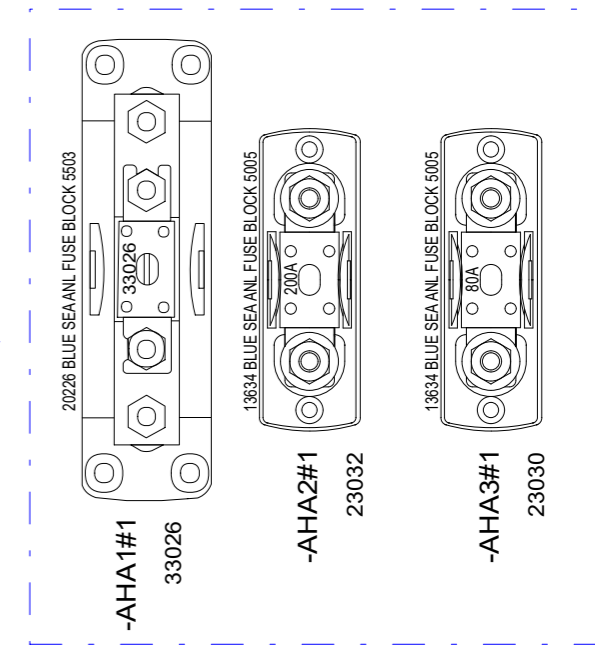
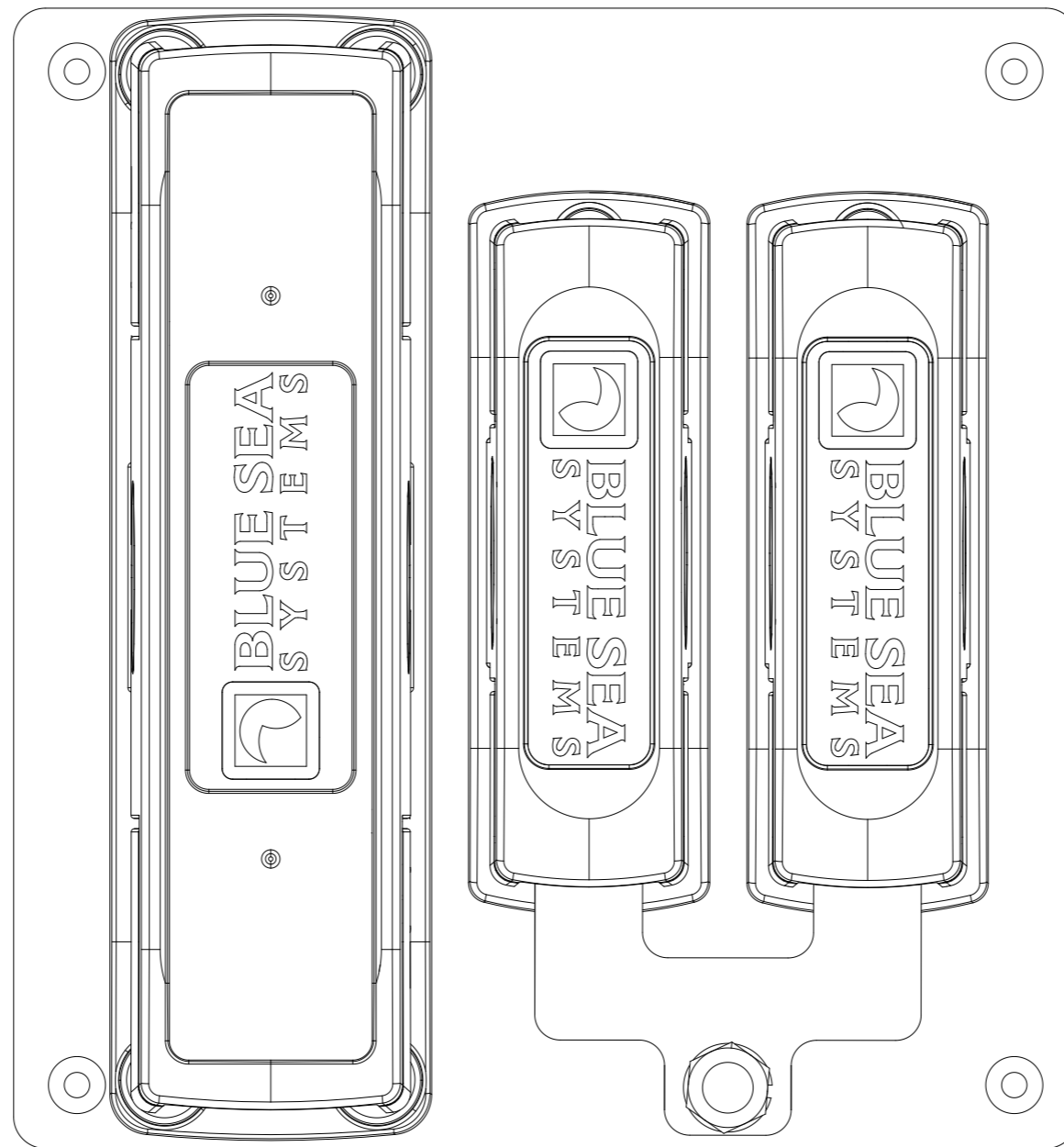

PACK WITH PRODUCT:
4PCS

VMI30916 - Countersunk head Screw HEX socket M4X14 DIN7991 C4

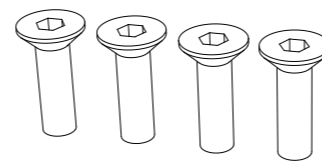

19.4.2024	PF	G1: 2005054; New product	Date	19.4.2024	NAVIX	Axopar	See exp. view	41197	Project ID
			Drawing by	PF	designed solutions	Boat	Sub-product code	Product code	
			Sheet rev.	1	Copyright by	37 MY25	STERN THRUSTER	HL	212 / 213
Date of modification	Modified by	Description	Project rev.	G		Boat model	CABLES	Loc	Sheet
1			4				Title		8

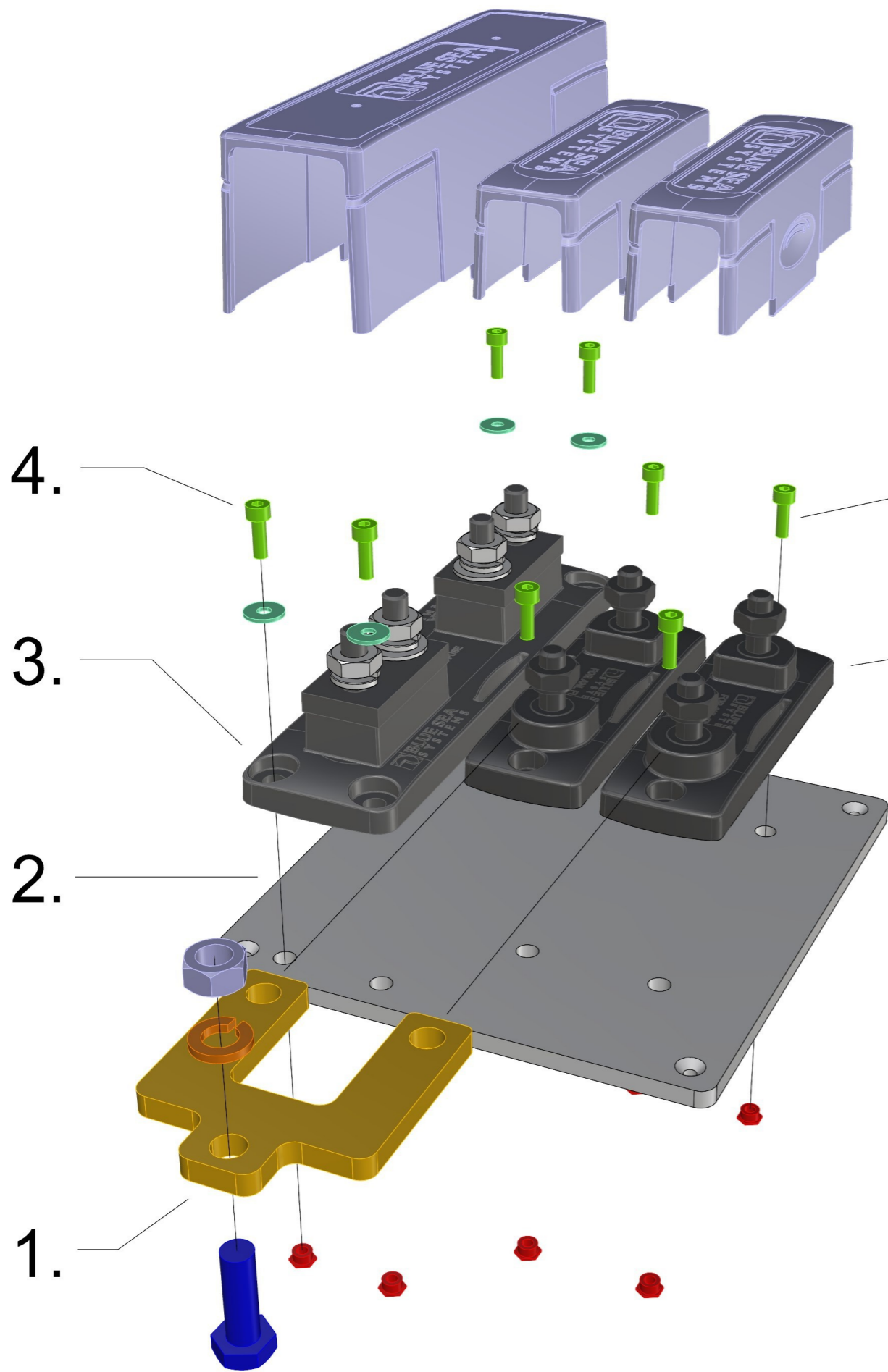

41258_AXOPAR_37_MY25_BATTERY_BOX_STERN_THRUSTER_MODULE

- 1. 1PC VMI32018 - HEX Bolt Full thread M8X25 DIN933 C4
 1PC 30142_ANL_CONNECTION_BAR_DOUBLE_V1
 1PC VMI32011 - Spring Lock washer M8 DIN127 C4
 1PC VMI32012 - HEX Nut M8 DIN934 C4
- 2. 1PC 41259_AXOPAR_37_MY25_B_BOX_STM_PLATE_V1
- 3. 1PC 20226 FUSE BLOCK ANL 35 750A Blue Sea 5503B BSS (AS IN DIAGRAM)
- 4. 4PCS VMI30944 - HEX socket Head Cap Screw M4X12 DIN912 C4
 4PCS VMI30907 - M4 Washer,large outside diameter 12mm DIN9021 C4
 4PCS 9872 - PURISTEVÄLIHOLKKI ETSOS-M4x4
- 5. 4PCS VMI30944 - HEX socket Head Cap Screw M4X12 DIN912 C4
 4PCS 9872 - PURISTEVÄLIHOLKKI ETSOS-M4x4
- 6. 2PCS 13634 - FUSE HOLDER ANL 35-300A w/cover - Blue Sea 5005B-BSS (AS IN DIAGRAM)

18.4.2024 / TS (2005054)

19.4.2024	PF	G1: 2005054; New product	Date 19.4.2024		Axopar	See exp. view	41197	Project ID
			Drawing by PF		Boat	Sub-product code	Product code	
			Sheet rev. 1		Copyright by	37 MY25	STERN THRUSTER CABLES	HL
Date of modification	Modified by	Description	Project rev. G		Boat model	Title	Loc	Sheet

CUSTOMER INSTALLATION INSTRUCTION

NAVIX installs holders, fuses and copper bar onto module 41258
 CUSTOMER installs main switch and module 41258 to 29617 BATTERY BOX FWD WALL PANEL

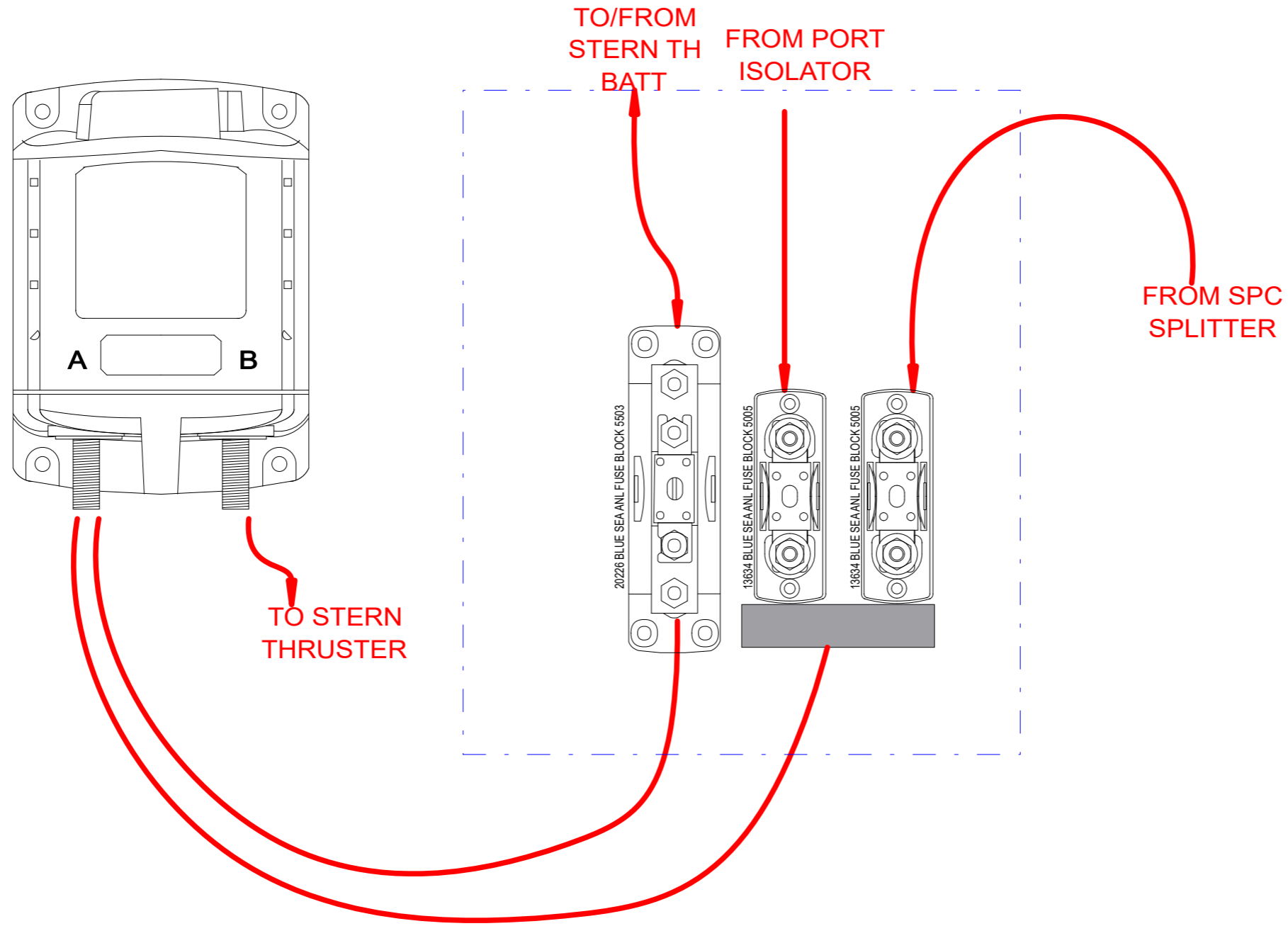

19.4.2024	PF	G1: 2005054; New product	Date 17.4.2024	 Copyright by	Axopar	See exp. view	41197	Project ID
			Drawing by PF		Boat	Sub-product code	Product code	
			Sheet rev. 1		37 MY25	STERN THRUSTER CABLES	Loc	214 / 213
Date of modification	Modified by	Description	Project rev. G		Boat model	Title	Sheet	

12 Appendix IV: AIS Decontamination – North America

According to

ABYC T-32 Design and Construction in Consideration of Aquatic Invasive Species 7/21

© 2021 American Boat & Yacht Council, Inc

Table of Contents

1 Decontamination criteria based on UMPS III, Table 3.....	3
2 Example of AIS Owner's Manual Information.....	4
3 Additional boat-specific recommendations.....	6

1 Decontamination criteria based on UMPS III, Table 3

The table is a summary of scientific research indicating the lethal water temperature at point of contact and duration for decontamination. Information is grouped by the location of the boat that is targeted and the life form of Dreissenid mussel targeted (e.g., adult mussel or veliger). Please refer to the *Student Training Curriculum for Watercraft Inspectors and Decontaminators to Prevent and Contain the Spread of Aquatic Invasive Species in the USA* for complete step by step procedures.

	Boat part/ location	Water temperature	Duration ¹⁾ (sec)	Type of application	Target life stage
Exterior	Hull	140°F	10	High pressure spray ²⁾	Adult
	Trailer	140°F	70	Low pressure spray ³⁾	Adult
	PFDs, anchor, paddle	140°F	10	Low pressure spray	Adult or Veliger
Propulsion system	Gimbal	140°F	132	Low pressure spray	Adult
	Engine	140°F ^{5), 6)}	See note ⁷⁾ .	Flush ⁶⁾	Veliger
Interior	Ballast tanks	120°F	130	Low risk – Flush ⁴⁾	Veliger
				High risk – Fill and flush	
	Live well/bait well	120°F	130	Low pressure spray or flush	Veliger
	Bilge	120°F	130	Flush or low pressure spray	Veliger

1) The times listed are the minimum times necessary to achieve mortality.

2) High pressure = 3000 psi.

3) Low pressure = using the pressure from the decontamination unit with no nozzle, not to exceed 60 psi (essentially a garden hose flow).

4) Flush = adding water to a compartment of a boat to treat or force the water out.

5) These temperatures denote the exit temperature (i.e., temperature of water exiting the boat not exiting the wand or flush attachment).

6) When flushing engines with a dedicated connection (not mufflers), the pressure should be limited to less than 60 psi to prevent internal engine damage. The maximum input temperature during flushing should not exceed 140°F.

7) *NOTE: Engine flushing relies on the exit temperature as a guideline for decontamination duration.*

2 Example of AIS Owner's Manual Information

Aquatic invasive species

Aquatic invasive species (AIS) are plants and animals that occur in waters in which they are not native and whose introduction causes or is likely to cause economic or environmental damage or harm to human health. AIS have a negative impact on the waterway, its native species, and recreational and commercial uses of the waterway.

As responsible boaters and citizens, each boat owner should do their part to prevent the spread of these aquatichitchhikers. In many cases, it is also required by law. Check local regulations for any waterway where you will boat.

After each boating trip, follow these three simple steps before you leave the water access to stop the spread of AIS: Clean, Drain, and Dry. This is the boater's way to help protect the environment from the damage that AIS can cause.



Clean

Inspect and remove all aquatic plants, animals, mud, and debris from the boat, engine, trailer, anchor, and any watersports equipment.

- Rinse, scrub or wash, as appropriate, away from storm drains, ditches, or waterways.
- Rinse watercraft, trailer, and equipment with hot water, when possible.
- Flush motor according to owner's manual.

Drain

Completely drain all water from the boat and its compartments, including but not limited to the bilge, wells, lockers, ballast tanks or bags, bait containers, engines, and outdrives.

Dry

Allow the boat to completely dry before visiting any other bodies of water.

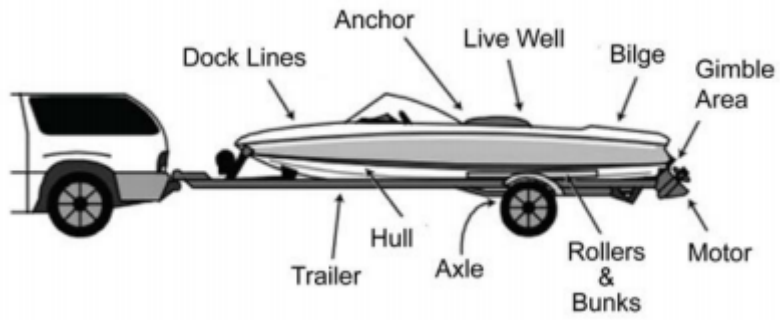

NOTE: Some localities may require inspection or decontamination before and/or after launching. Check state and local laws and regulations for requirements prior to traveling to go boating.

3 Additional boat-specific recommendations

Nonmotorized watercraft

Canoes, rafts, kayaks, rowboats, paddleboats, inflatables, sculls, and other nonmotorized recreational watercraft also require proper treatment.

- **Clean** straps, gear, paddles, floats, ropes, anchors, dip nets, and trailer before leaving the water body.
- **Dry** everything completely between each use and before storing.
- **Wear** quick-dry footwear or bring a second pair of footwear with you when portaging between waterbodies.

Sailboats

- **Clean** centerboard, bilge board, wells, rudderpost, trailer, and other equipment before leaving the water body.
- **Drain** water from boat, motor, bilge, ballast, wells, and portable bait containers before leaving the water body.

Motorized watercraft

- **Inspect** and **clean** motor or engine, including the gimbal area; trailer, including axles, bunkers, and rollers; anchors; dock lines; and equipment before leaving the water body.
- **Drain** live wells, bait containers, ballast and bilge tanks, and engine cooling systems.

Jet boats and personal watercraft (PWCs)

- **Inspect** and **clean** hull, trailer, intake grate, and steering nozzle, etc.
- **Clean** hull, trailer, intake grate, and steering nozzle, etc before leaving the water access.
- **Run** engine 5-10 sec to blow out excess water and vegetation from internal drive before leaving the waterbody.

13 Appendix V: Strapping and transport

REVISIONS			
REV.	DESCRIPTION	DATE	APPROVED

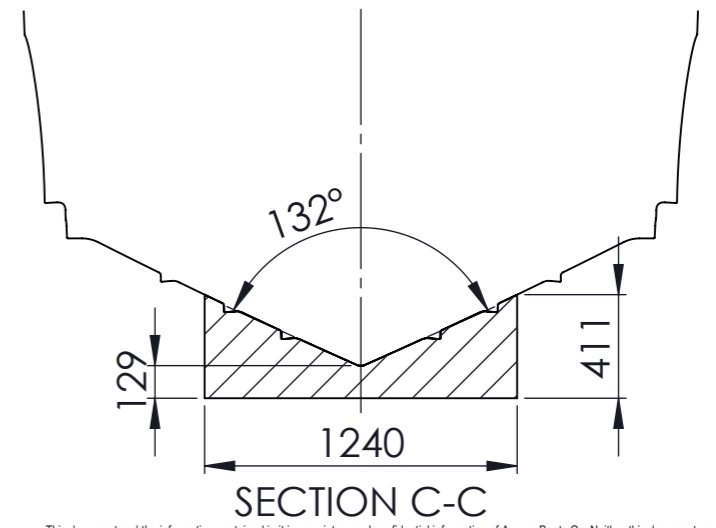
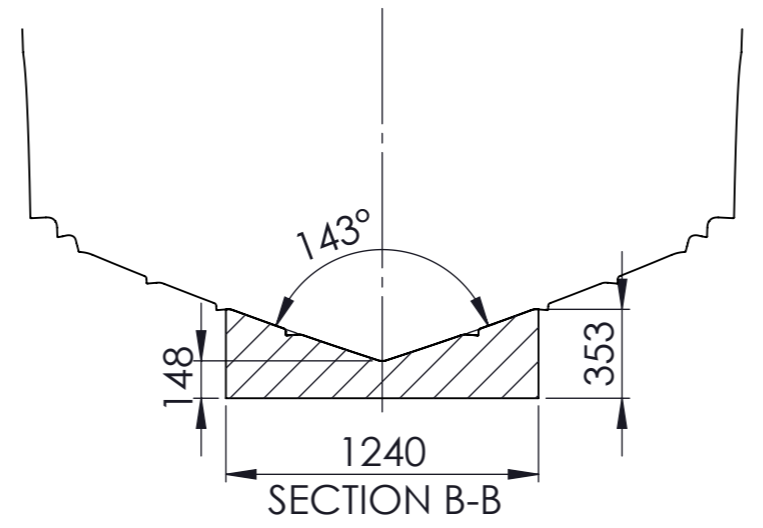
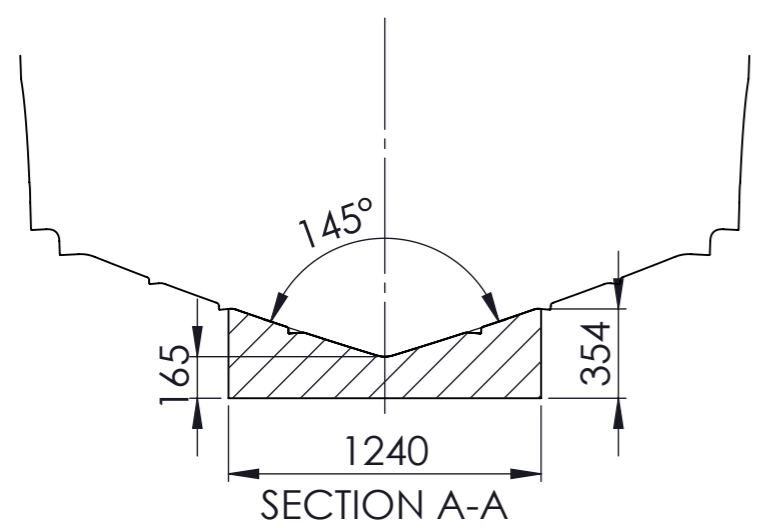
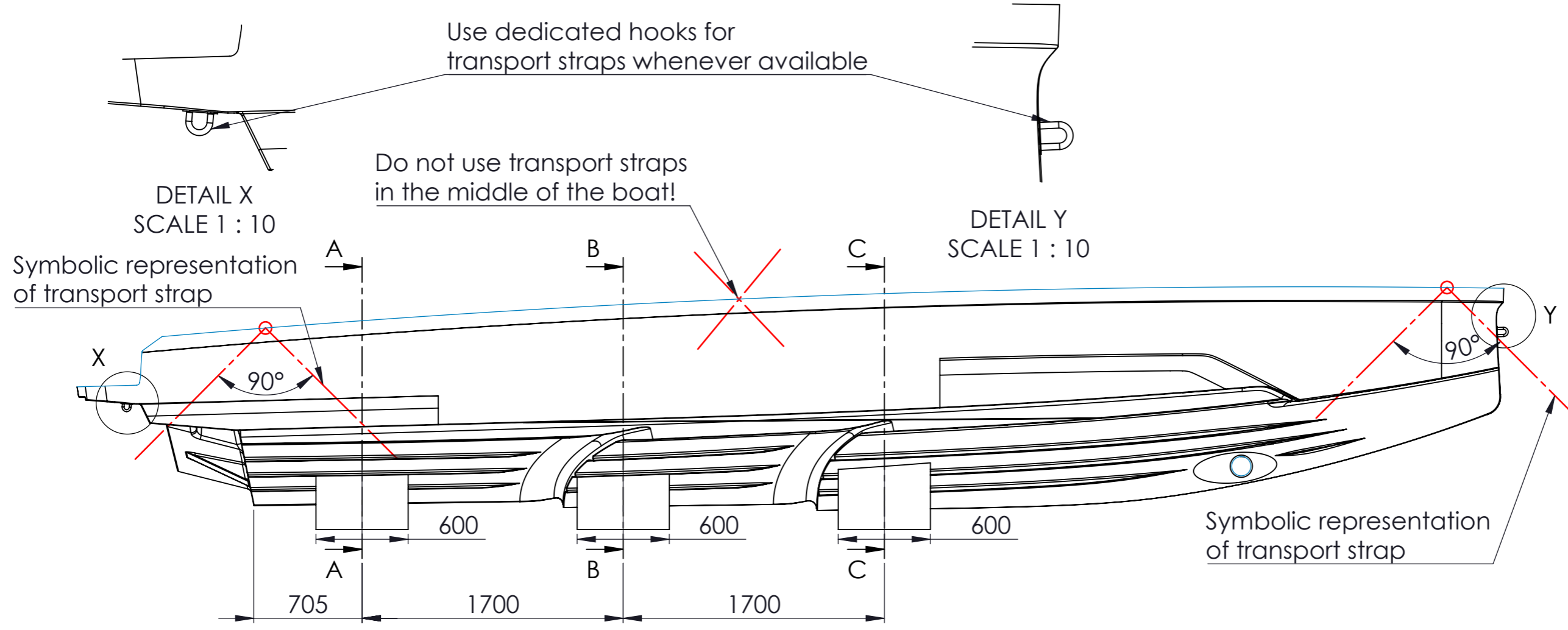

NOTE:
 1. Material of cradles: Foam.
 2. For transporting and securing the boat, use transport straps only in the indicated places (aft and bow side).

This document and the information contained in it is proprietary and confidential information of Axopar Boats Oy. Neither this document nor any of the information contained herein may be reproduced, disclosed to others, or used for any purpose other than for the purpose it has been provided without the prior written permission of Axopar Boats Oy.

AXOPAR		ITEM	REV
BOAT MODEL AX28 MK3		DRAWING	A
MODEL YEAR 2023		REV	0
BY	DATE	DESCRIPTION	SCALE
CREATED	ANTMIH	03.10.2023	Strapping and Transport
CHECKED	L.C.	03.10.2023	TECHNICAL DESCRIPTION
ACCEPTED	AJU	08.11.2023	Manufacturing specification
			PAGE
			1 / 1

